















Touchwin advanced function

User's manual

WUXI XINJE ELECTRIC CO., LTD.

Catalog

1. OVERVIEW	4
1.1 WHAT IS ADVANCED FUNCTION?	4
1.2 ADVANCED FUNCTION’S ADVANTAGE	4
1.3 USING ADVANCED FUNCTION’S CIRCUMSTANCES	4
2. OPEN ADVANCED FUNCTION.....	5
2.1 OVERVIEW.....	5
2.2 SPECIFIC OPERATIONS.....	5
2.2.1 The advanced instruction’s opening method of use V2.99 and below touch-screen software..	5
2.2.2 The Advanced instruction’s open method of V2.c.3 and above touch-screen software.....	7
3. THE STRUCTURE AND COMBINATION OF ADVANCED FUNCTION.....	10
3.1 STRUCTURE.....	10
3.2 COMBINATION	12
3.2.1 Property contain.....	12
3.2.2 Property Link.....	16
3.2.3 Property Float.....	18
3.2.4 Insert Unit	23
4. COMPONENT FUNCTION INTRODUCE	28
4.1 OVERVIEW.....	28
4.2 PART INTRODUCTION	28
4.2.1 Switch  component.....	28
4.2.2 IF element.....	36
4.2.3 Text	39
4.2.4 User input.....	42
4.2.5 Screen jump.....	44
4.2.6 Password  and Open password 	49
4.2.7 Arithmetic 	54
4.2.8 NOP 	65
4.2.9 Converse 	66
4.2.10 “And, Or, Not” 	69
4.2.11 “Compare” 	73
4.2.12 Edge 	76

4.2.13 Window 	79
4.2.14 Date D	90
4.2.15 Conversion	92
4.2.16 Range check FW	98
4.2.17 Key 	101
4.2.18 RTC set clock rtc	107
4.2.19 "Read" 	109
4.2.20 "Write"	110
4.2.21 Block	117
4.2.22 Count	130
4.2.23 Pulse	134
4.2.24 LED LIGHT	137
4.2.25 Print	140
4.2.26 Sin	142
4.2.27 Arcsin	152
4.2.28 Power	160
4.2.29 Sqrt	170
4.2.30 Buzzer	180
4.2.31 Back Light	185
4.2.32 Serial port send	190
4.2.33 Cycle element	198
5. ADVANCED FUNCTIONS INTEGRATED APPLICATION	218
5.1 REGISTER OVER THE VALUE OF CLEARED	218
5.2 THREE-POSITION SWITCH	221
5.3 BUTTON INTERLOCK	230
5.4 COIL CONTROL INVISIBILITY	233
5.5 COLOR CONVERSION OF FONT	237
5.6 REGISTER CONTROL SWITCH PICTURES	243
5.7 WORD CONTROL COIL OUTPUT	253
5.8 SCROLL TEXT	263

1. Overview

1.1 What is advanced function?

Advanced function contains many advanced function parts, each part like a function block; to combine them together you can achieve rich functions that can not be achieved by common components. These parts are different from common components such as button, lamp and so on.

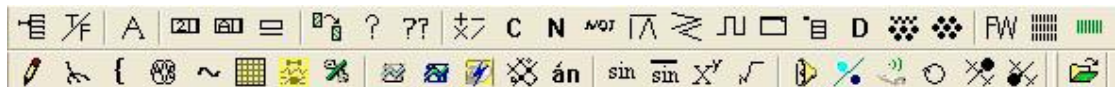

1.2 Advanced function's advantage

Advanced function is the script function of touch win. It uses flow chart but not C language which is different from SCADA script. It is as better as using C language and the steps are simple.

Advanced function	Configuration script function
	<pre>if(\\本站点\计>=75&&\\本站点\计<=90) { 历史曲线.ScooterPosLeft=历史曲线.ScooterPosLeft+0.05;} if(\\本站点\计>=150&&\\本站点\计<=160) {SQLPrev{ DeviceID };K=66;}</pre>

1.3 Using advanced function's circumstances

When the common components can't meet customer's requirements, or need to do logical operations, we need advanced function.

2. Open advanced function

2.1 Overview

The toolbar of Advanced function in software is not visible, please open the function according to the following steps.

2.2 Specific operations

2.2.1 The advanced instruction's opening method of use V2.99 and below touch-screen software

- 1) Right-click the shortcut icon of Touch-screen installation software on the desktop, select attribute in the pop-up interface, shown below:
- 2) Pop-up Properties dialog box
- 3) Click "shortcut" option then select "search target (F)", Will jump to the following window

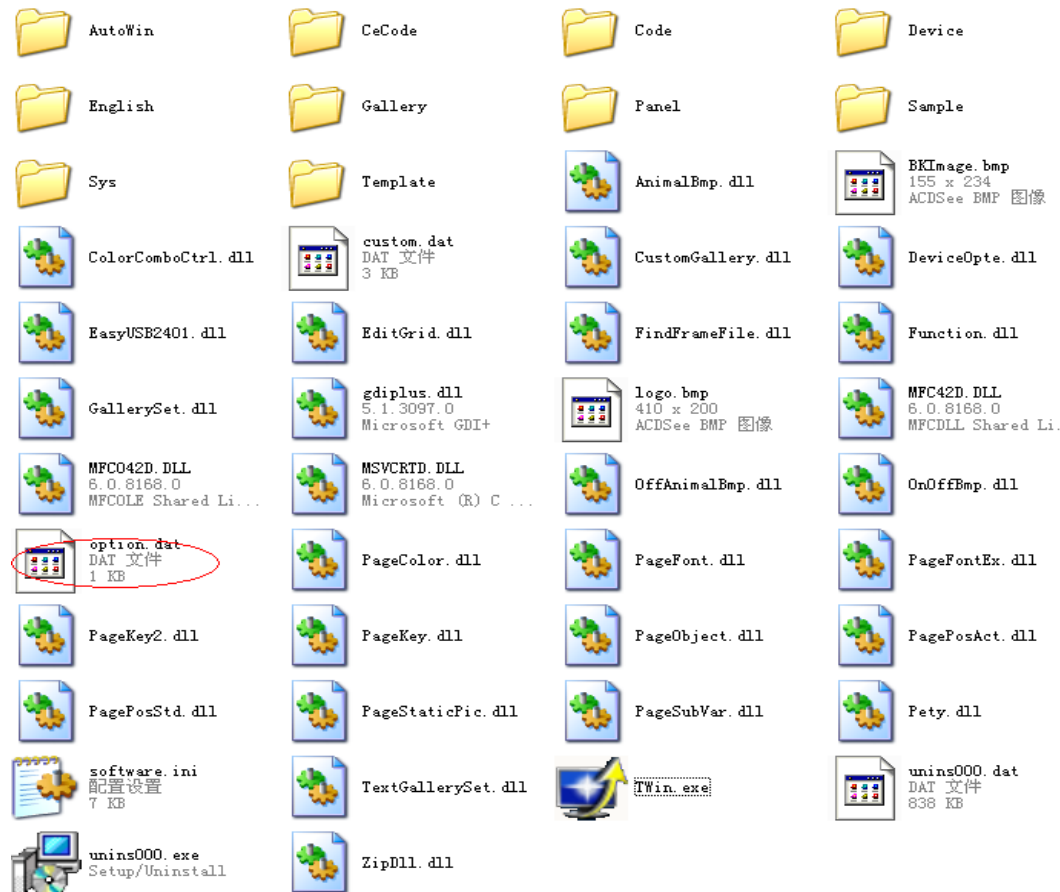

4) Find the file “option.dat.” , as shown below:

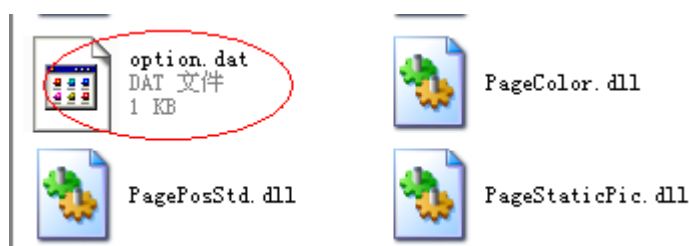

Note: After installing the software, you may not find the option.dat. file, If you want to find this file, Firstly, you must build a new project and save it, close the project , then in accordance with the above operation you will find the option.dat file .

5) Right-click option.dat, choose “open mode (H)...” , As shown in the following diagram :

6) Pop-up the following dialog box:

7) Click “open mode (o)...” button , Pop-up the following dialog boxes :

8) Choose "choose program from the list " and then click “ok” button, open the following dialog box:

9) In the “open mode” dialog box , select “note” from "program (P)" , and click "ok" button to open option.dat. file, contents are shown below :

Note:

① If the contents of the opening option.dat file, difference from the above, please don't worry, it will not affect the normal operation, as long as you follow the following steps continue to operate.

② One option.dat file can not occur two [software] at the same time , Therefore, after opening Option.dat file, first to check whether the file contains a [software] , if contain, in another new line behind [software], input usermode = 1 , Save and close the file, then you can open advanced function of touch screen, otherwise follow the following operations:

10) If the file do not have [software] , in the end of the file point to other line, then input[software], in the next line, input usermode = 1, such as shown below:

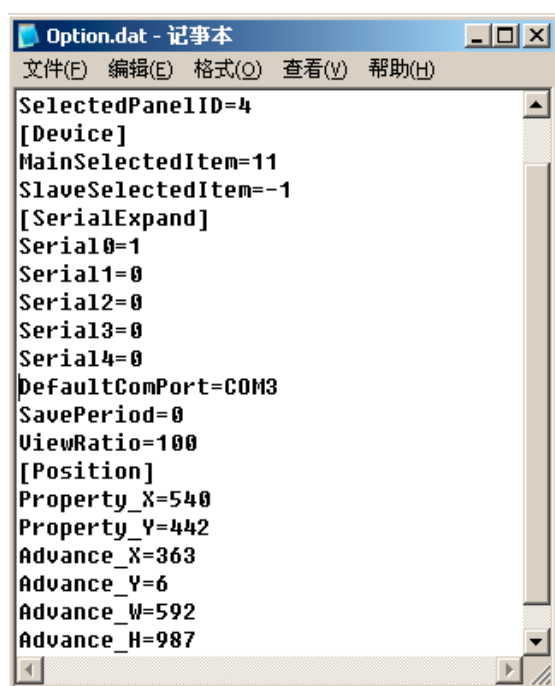

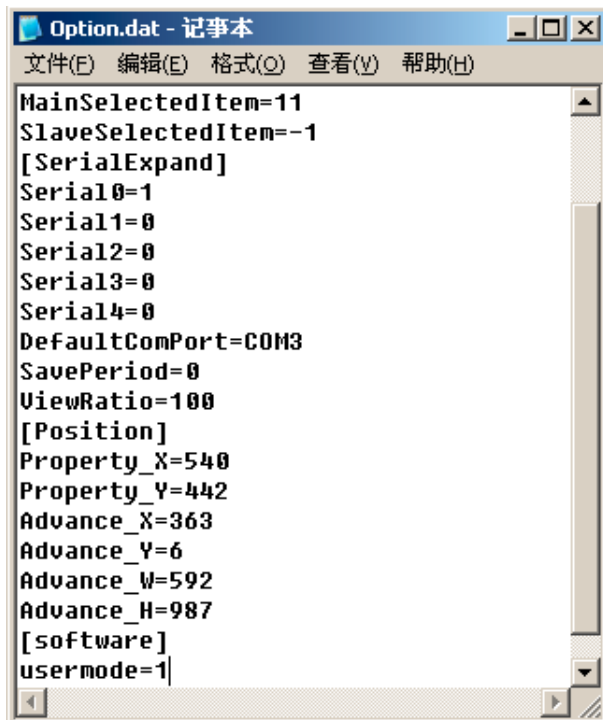

```
Option.dat - 记事本
文件(F) 编辑(E) 格式(O) 查看(V) 帮助(H)
MainSelectedItem=11
SlaveSelectedItem=-1
[SerialExpand]
Serial0=1
Serial1=0
Serial2=0
Serial3=0
Serial4=0
DefaultComPort=COM3
SavePeriod=0
ViewRatio=100
[Position]
Property_X=540
Property_Y=442
Advance_X=363
Advance_Y=6
Advance_W=592
Advance_H=987
[software]
usermode=1
```

11) Finally save and close the file.

12) Close the touch screen software and open again , then you can see advanced instructions already opened .

The operations of opening advanced instructions to V2.99 version and the below has been completed, the following will describe how to open advanced instructions to V2.C.3

2.2.2 The Advanced instruction's open method of V2.c.3 and above touch-screen software

1) Open V2. C. 3 software, and build a new project, select any panel type, as shown below:

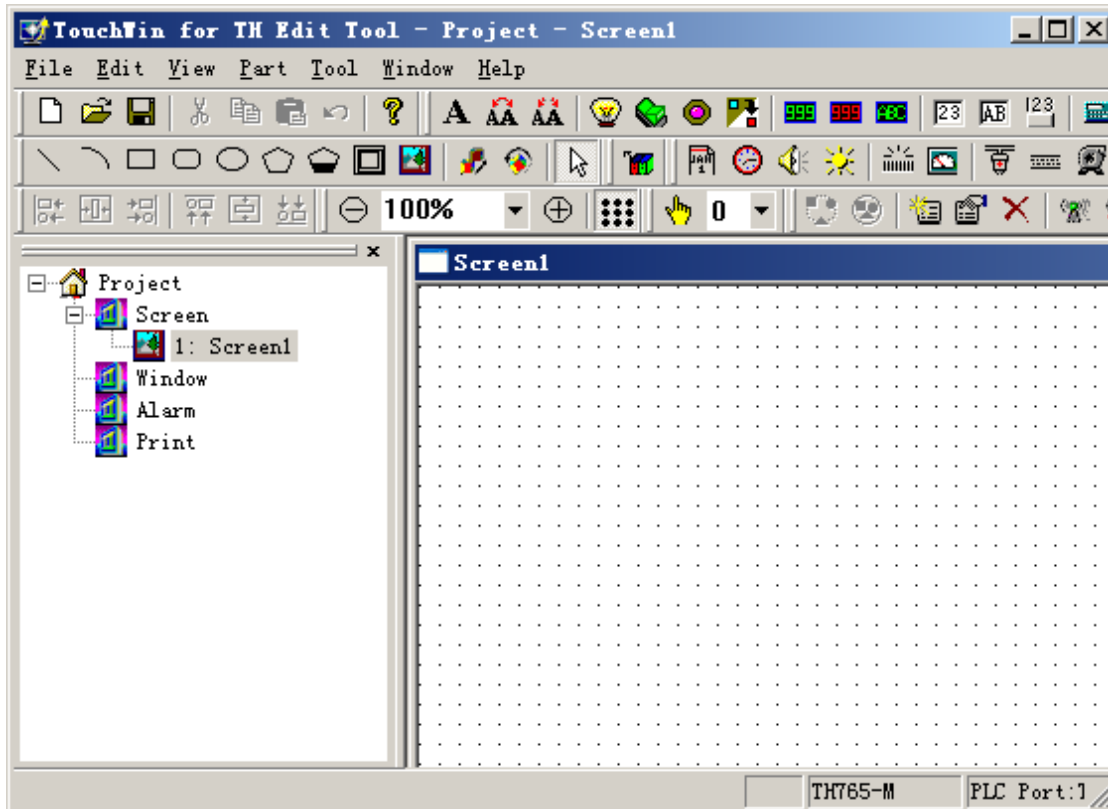

2) Then, open menu bar "Tool", select "option", as shown below:

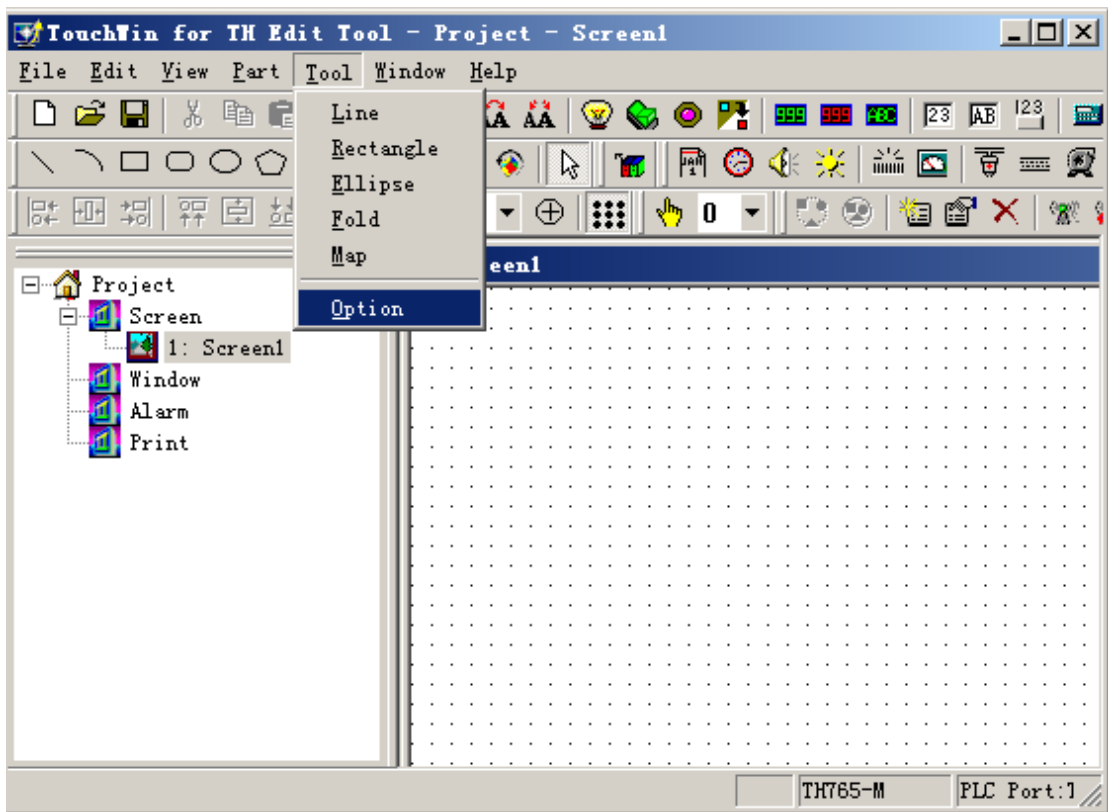

3) Pop-up the following dialog box , as shown below :

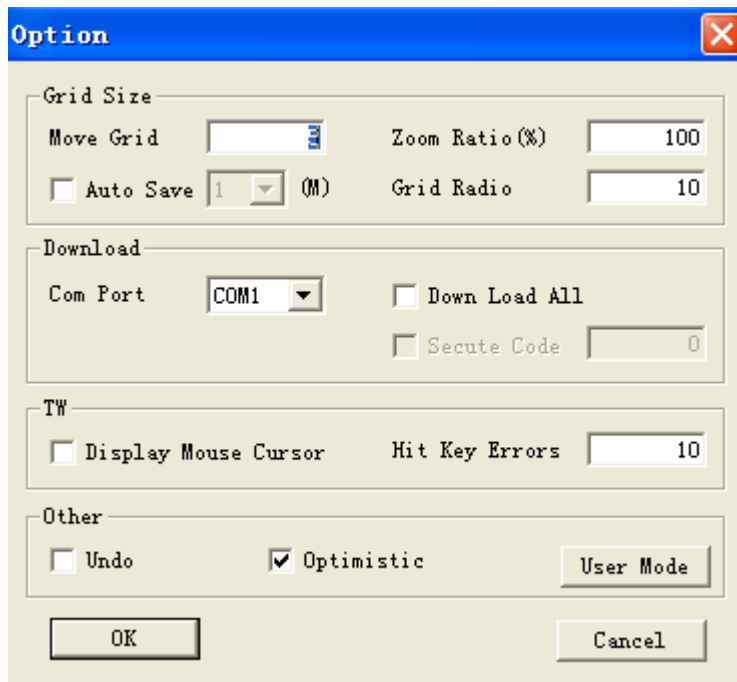

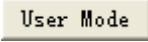
4) Click "User Mode" button , it will pop up the following dialog box :

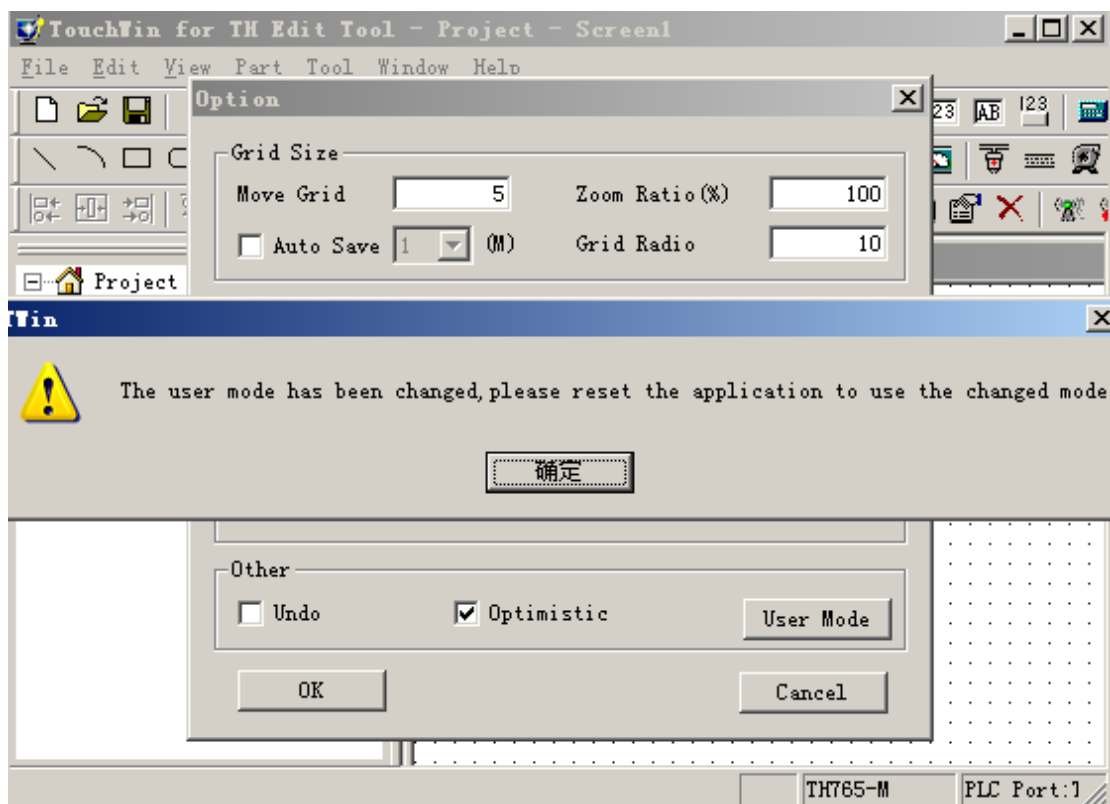

5) Click "OK" button, then close the project (don't need to save),open the software again .then you can see the screen has been opened advanced instructions.

The above is the introduction about the opening of touch screen advanced instructions to V2. C. 3

and above version.

3. The structure and combination of advanced function

3.1 Structure

Here, there must first be recognized, in fact, all the component parts in the toolbox are constituted by these advanced function parts , Advanced function components can be seen as a tiny function unit , similar to a chip, different chips can be realized certain functions through combination .

Composition structure is shown below:

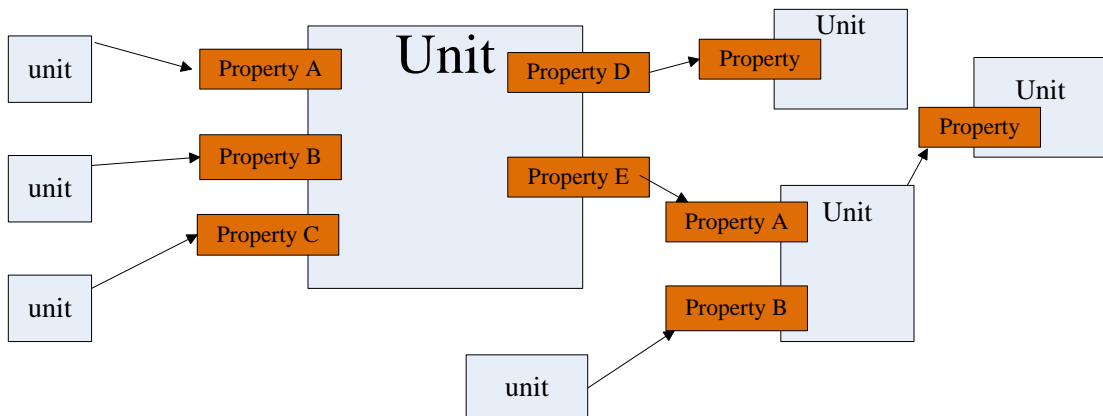

Advanced function's Composition structure

In order to deepen the understanding, we use a "text" component as an example to introduce its connotation.

● First introduce how to open component's advanced property:

- ① Place one "text" part  on the screen, Choose it and right-click , In the pop-up menu, select "Advanced", it will bring up the Advanced property box:

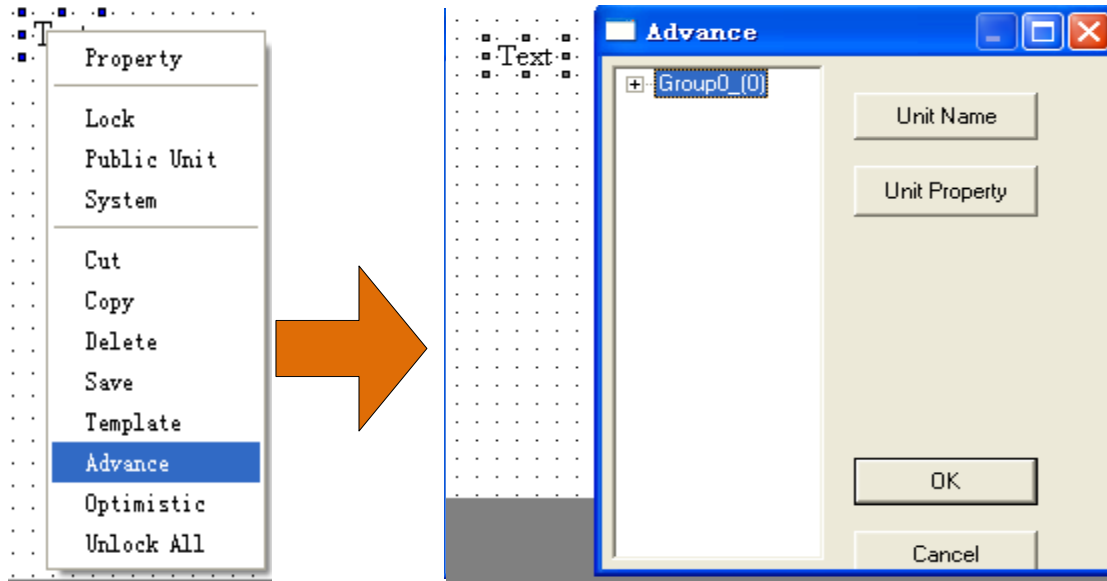

② Grading Open dialog box of “Group” , We find that this "group" (text) is constituted by self unit and self property, as shown below:

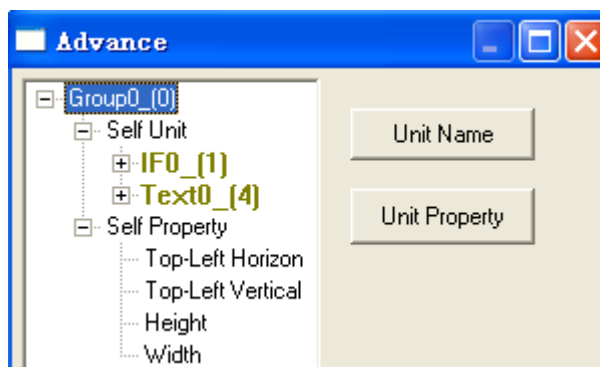

Self unit refers to the basic components of this component. The self property is a description of component's (in this case refers to "Group") status or nature.

③ Constitute the “text” part are actually "IF" and "text" elements. Grading open IF component again

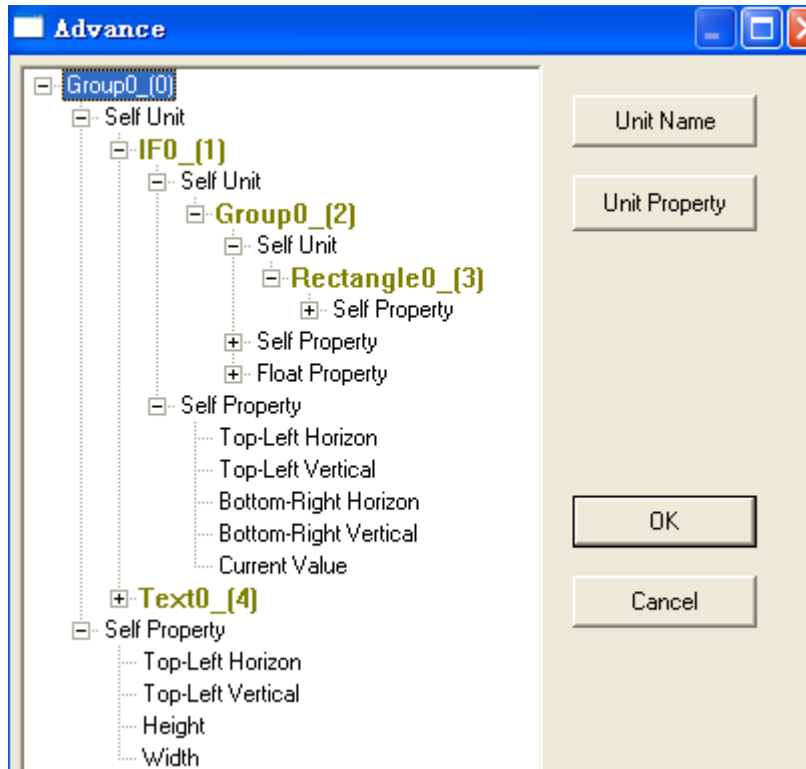

IF element is composed by two rectangles. Such layers open, we can find that in fact all the components are composed by advanced units through a series of methods and logic , Through these basic elements, we can get any parts and functions what we want.

3.2 Combination

Advanced function components have four combination types:

- Property contain
- Property link
- Property Float
- Insert unit

Please see the following examples.

3.2.1 Property contain

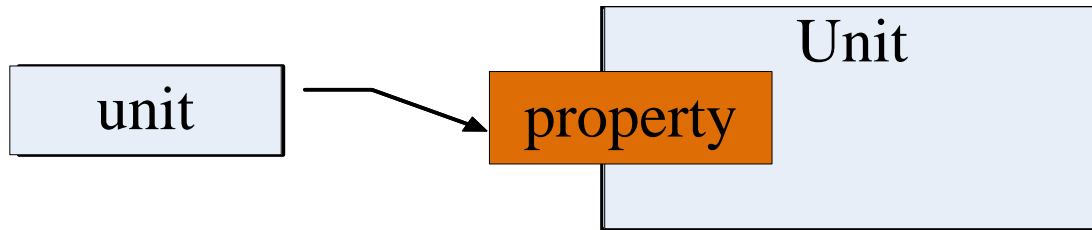

Definition: The properties of components to contain the other components, that is, contained components as property's data source.



Property has a data source after contained

Description: contained components must be able to reflect the change of numerical value, such as: “Read” element , can reflect the numerical quantity or bit status (0 or 1 two states).
 “Data comparison” element, can reflect the results of true or false (0 or 1 two states)

Example: Through the value of PSW300 and PSW301 to control a rectangle’s length and height.

1 Placing one rectangle  ,2 “read”  on the screen:

Double-click“read ”element then in the pop-up dialog box, modify the two read unit’s property , point separately to PSW300 and PSW301 ,the set methods are shown below:

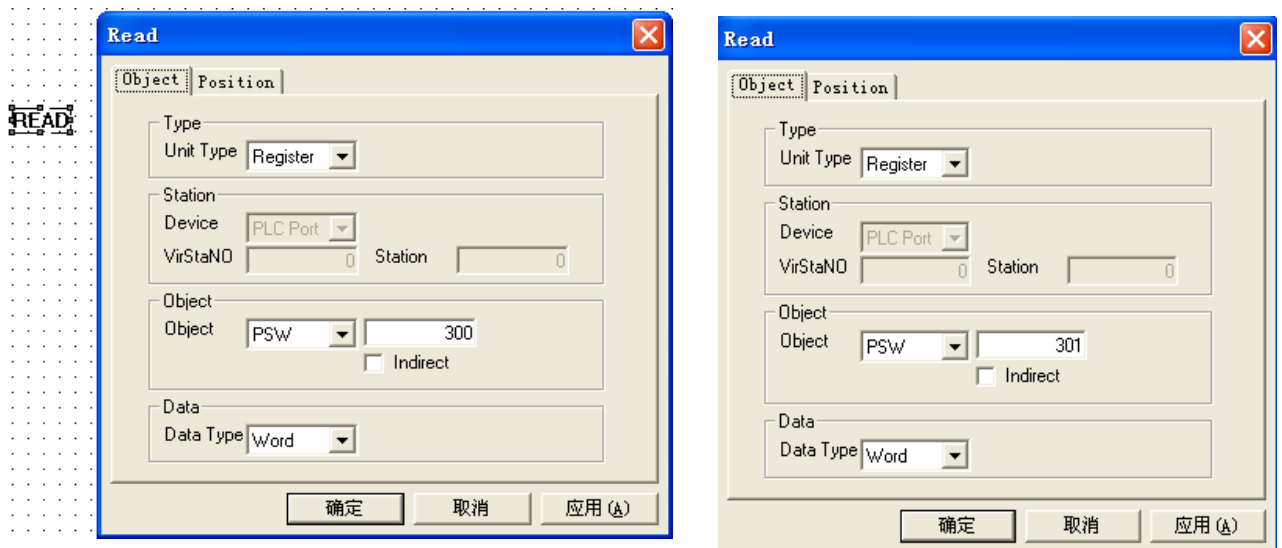

②Box above components, right-click will pop-up advance dialog box:

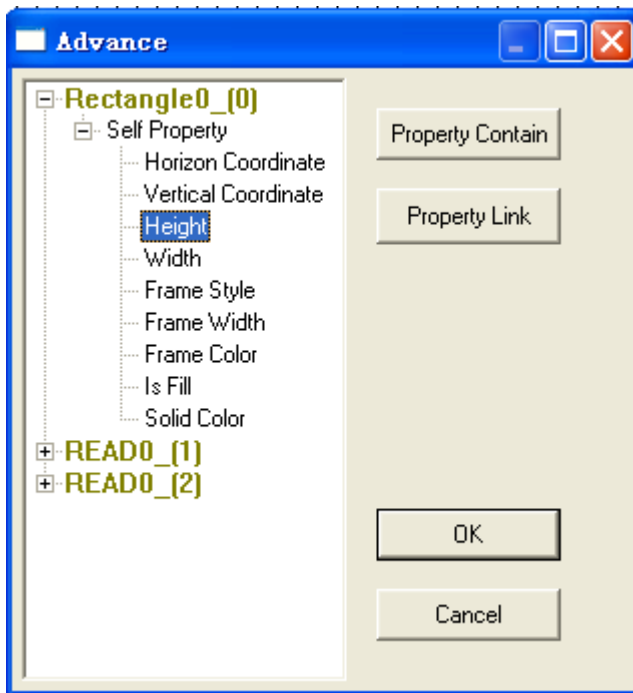

●The "height" attribute of rectangle property contain the “read” element of PSW301.

Procedure: click **Height** --click **Property Contain** button --select **READO_ (1)**

(corresponding PSW301) -- click **Affirm Contain** .

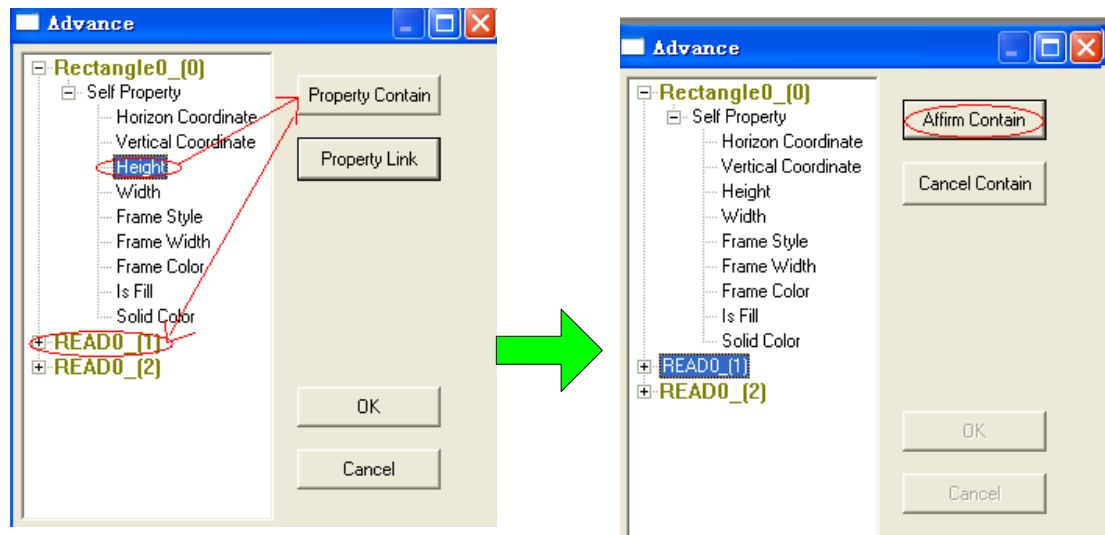

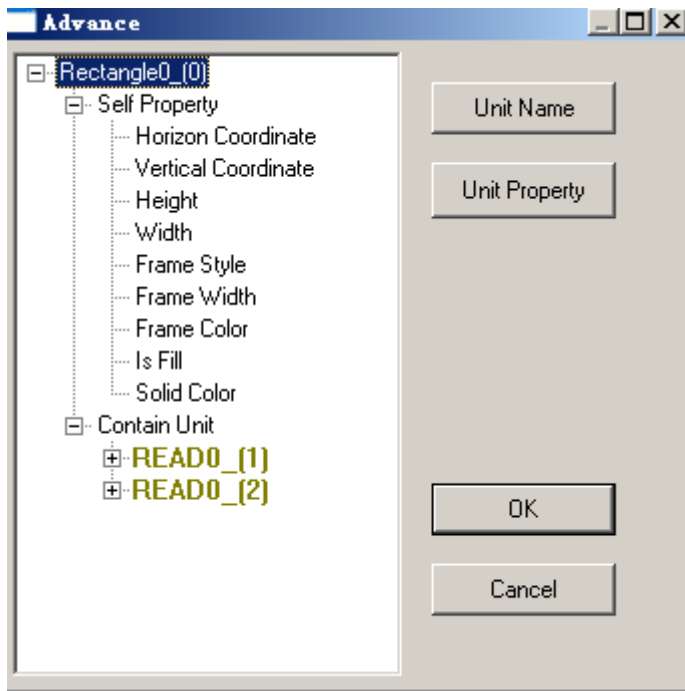

●The "width" attribute of rectangle property contain the “read” element of PSW300.(as the above methods)

Click "ok" button to quit after the completion. The final effect are shown below:

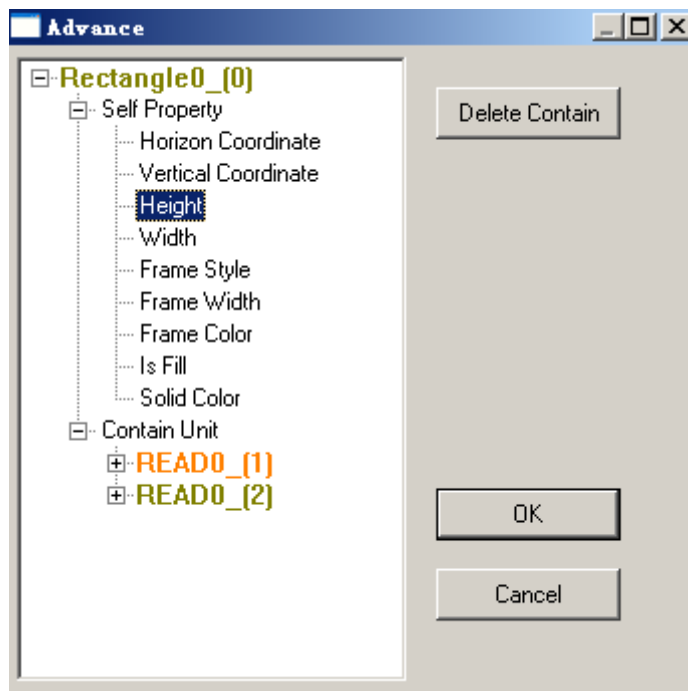

Rectangular in one more a “contain unit” , all the contained components are put in this area, while clicking the “ height” or “width” attributes of rectangle, the contained element will become an orange.



- ③ Placing two “digital input” parts  on the screen:
- “Digital input” address corresponding to PSW300 and PSW301
After the completion, the figure are shown below:

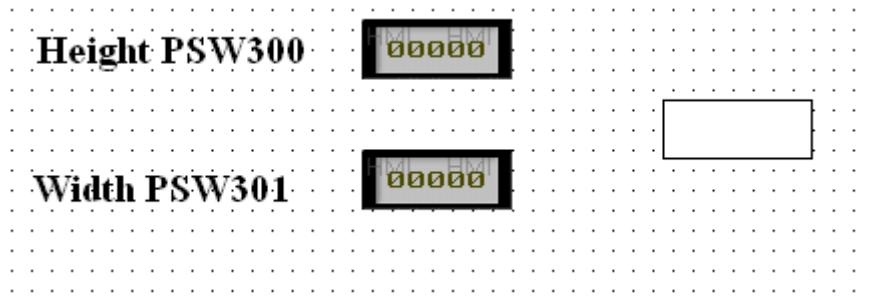

④ Click the “off-line simulation” icon on the software , Change the value of the two digital input , then the length and width of the rectangular will change, See the following simulation results:



3.2.2 Property Link

Definition: property link is to contact the two property unit which belong to the same element, When the contacted attribute changes , contact attribute also change.

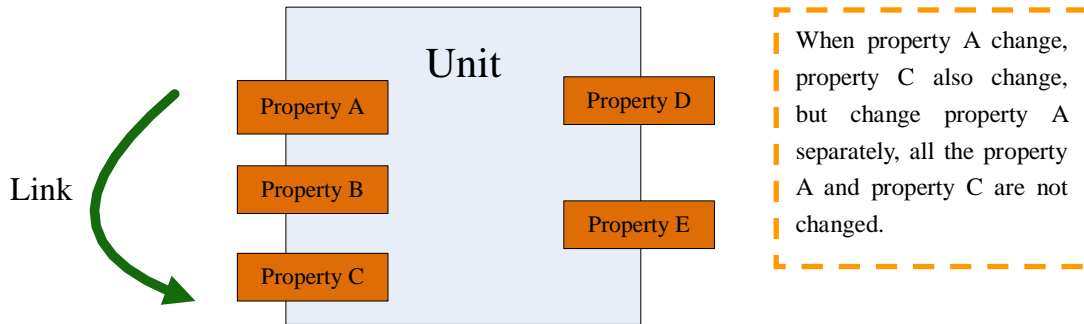

Description: 1.property link can only operate the different property in the same element , cannot cross components to execute property link。

2. The property must be the same type. Such as length and width, fill color and line color, Horizon coordinate and Vertical coordinate。

Example: property link “length” and “width” of the rectangle.

- ① Put one rectangle  on the screen
- ② Right-click the rectangle, pop-up the following dialog box:

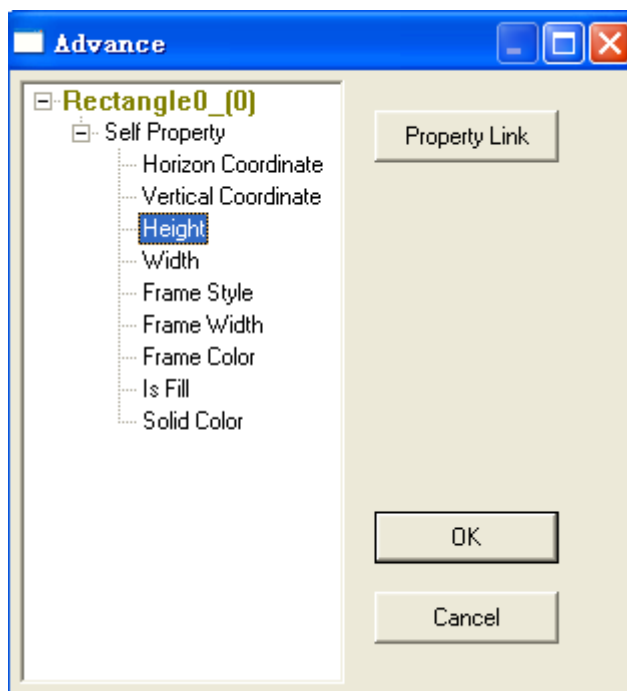

- “Height” of the rectangle property link “Width”

Procedure: select -click -select -click

 .

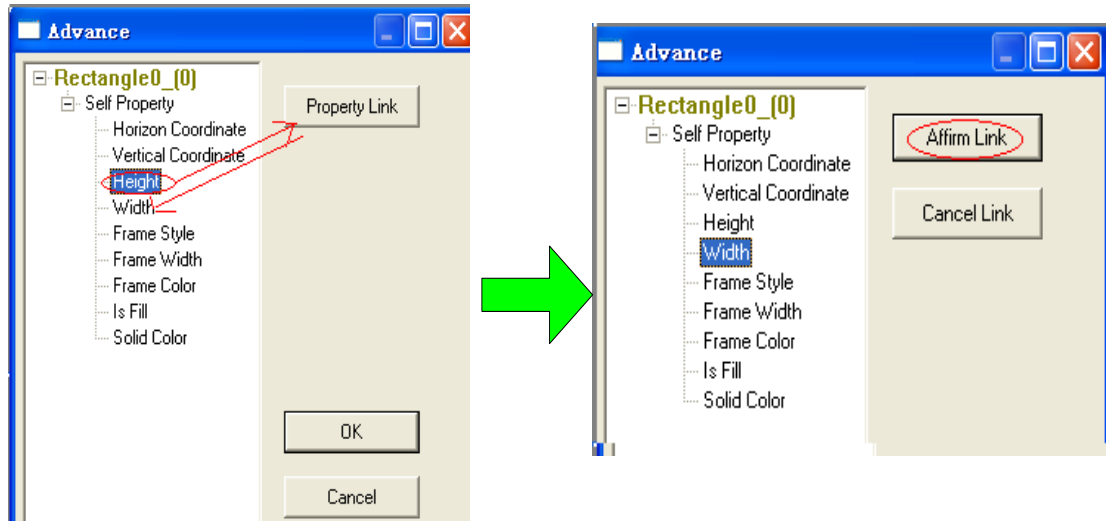

③ After the completion, click "OK" button to exit. As the following diagram:

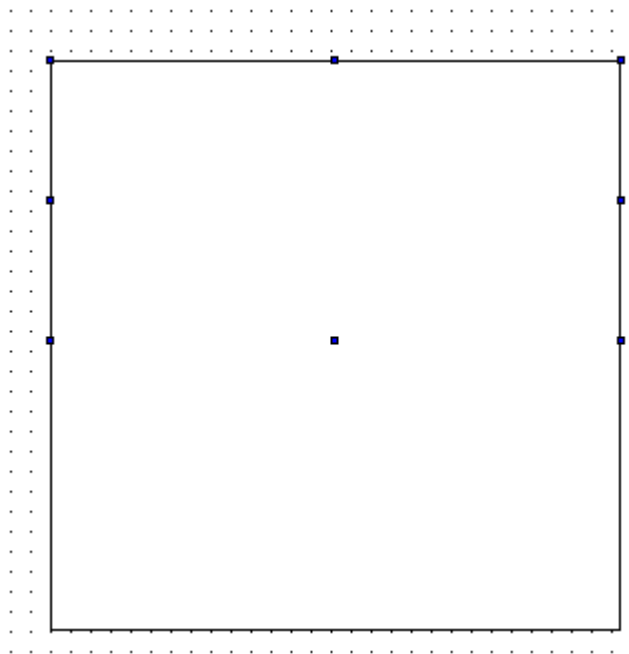

You can see, the original rectangle changed into a square. Manually widen the width of the rectangle, the height of the rectangle will be a corresponding larger, and still remain as a square.

Note: However, if properties belong to two units want to contact, the direct property link can not be operated. Then in the “property float” to explain this situation,

3.2.3 Property Float

Definition: unit property of "self unit" can be floating operation, rising as component's property, That the original properties of different components can belong

to the same upper unit.

For example, when two elements combination, can be property float:

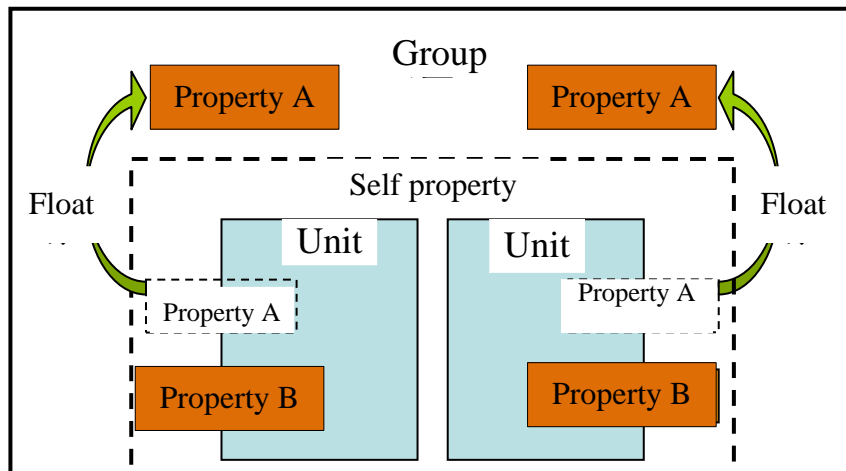



Property all belong to "group" unit

Note: To make an element containing “self unit”, there are 2 methods:

- 1 using the "Insert unit" operation to insert other components to this component .
2. The two or more components were combined, then these components will become the group's “self unit”

Example: Let a rectangle and an oval's frame color keep Consistent ,as long as the rectangle change the color, ellipse will change at the same time .

Note: This rectangle and ellipse are two separate components, their properties can not be cross-linked, it must let their properties belong to the same "group."

- ① Put one rectangle  and one ellipse  on the screen.

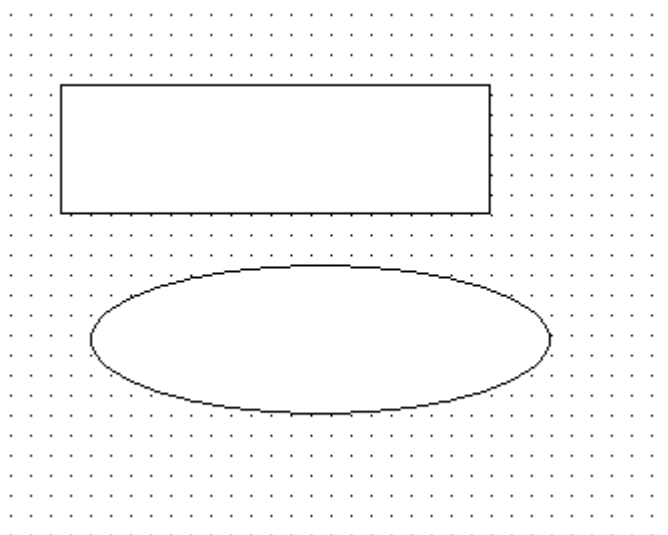

- ② Box select the two graphics, right-click to choose "group", as follows:

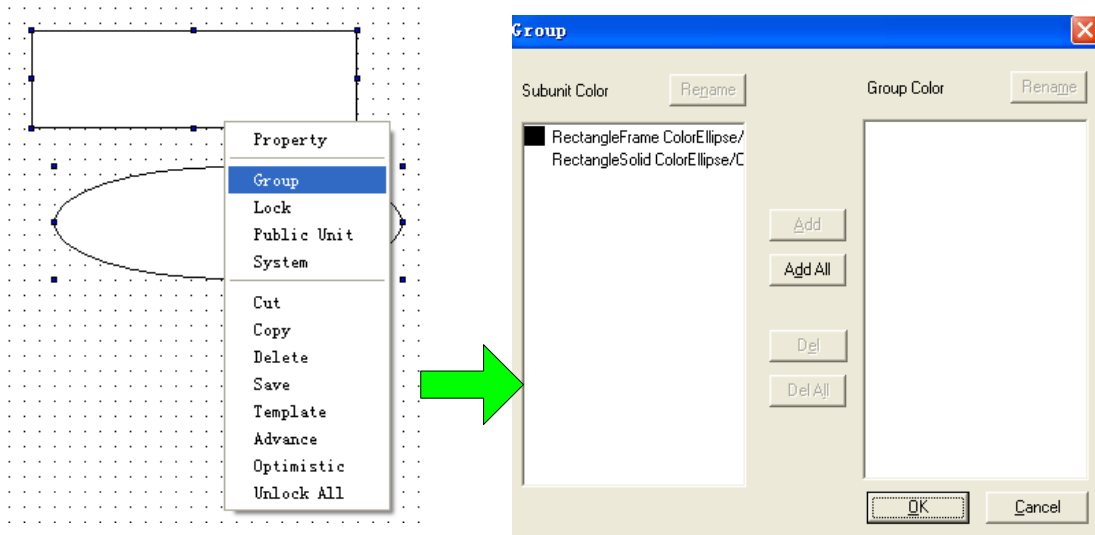

Click "OK" button to complete it

③ Right-click the group , pop-up the following dialog box:

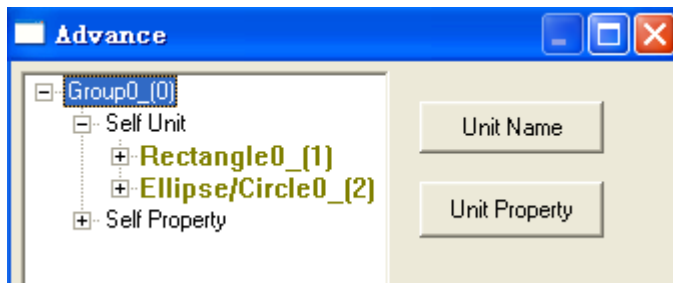

Can be seen under the "Group" more of a "self unit" part , self unit constitute the group of all the components. Ellipse and rectangle were included.

●Rectangle's "Frame color" property float to the group.

Steps: select **Frame Color** --click **Property Float** button—select **Group0_ (0)** --click **Affirm Float**

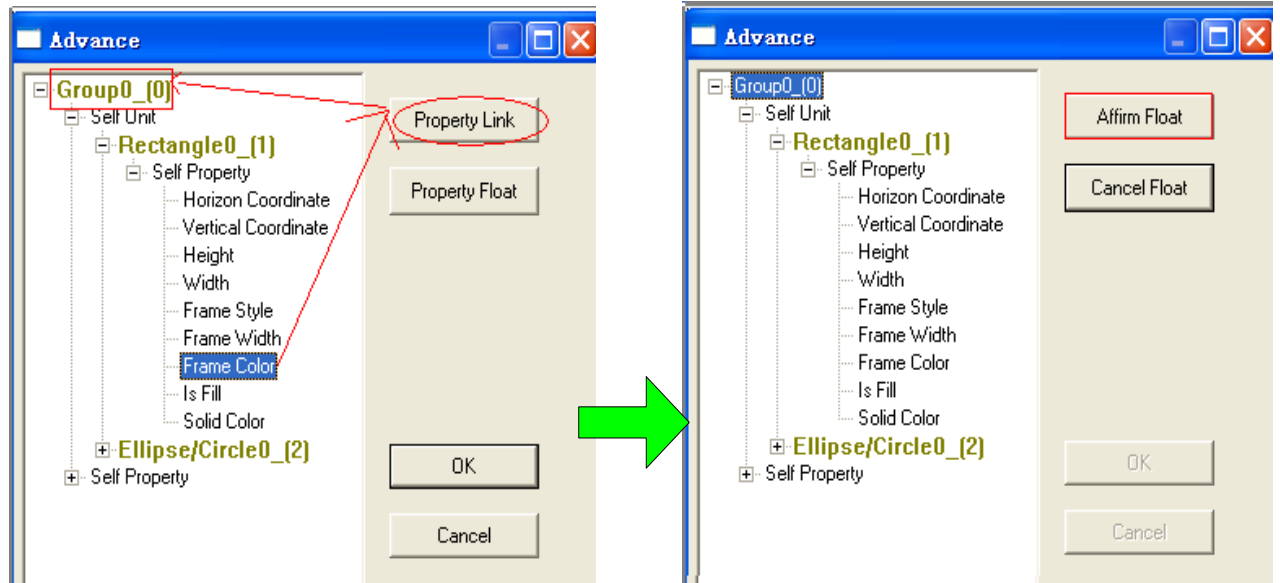

- Ellipse's "Frame color" property float to the group.(as the above methods)
After the completion of the following diagram:

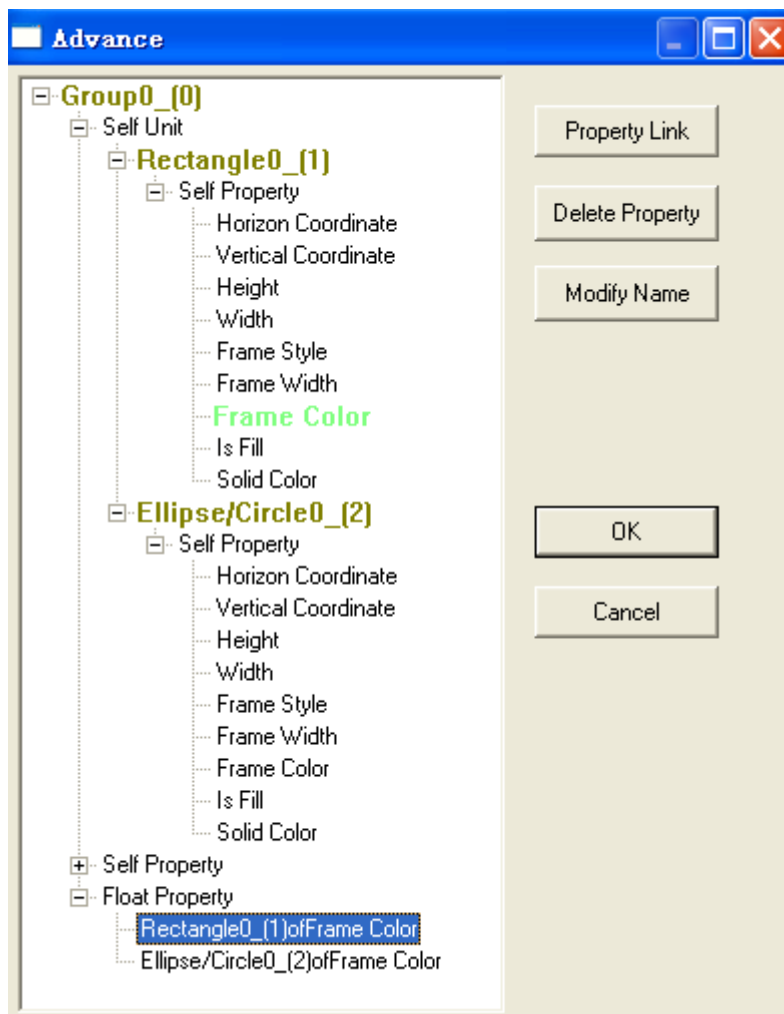

Under "Group" more of a "Float Property" section, floated properties are concentrated in the

section, click one of these attributes, its original location will become green.

- In the float property section, property link "Frame Color" of ellipse to rectangle's "Frame color.", the operations can be seen in "property link" section.

After the completion of the following diagram:

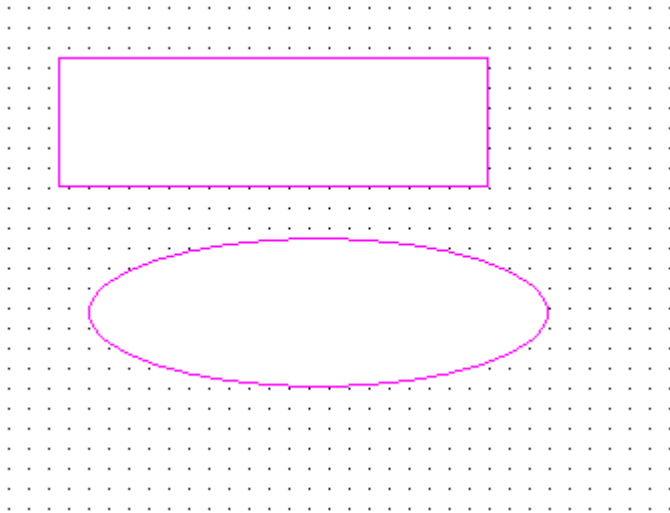

Double-click the "group", in the pop-up Group Property dialog box , you can modify the rectangle and ellipse's frame color respectively , you can see regardless how to set up the ellipse's frame color, it is always maintain the same with rectangle's frame color.

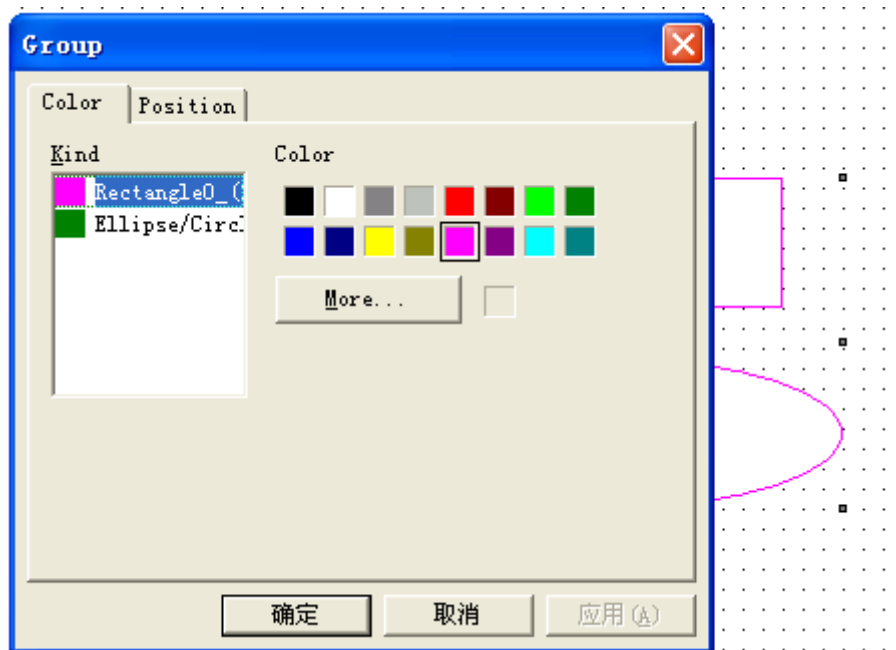

3.2.4 Insert Unit

Definition: change one component into another component's Component, to become "self unit".

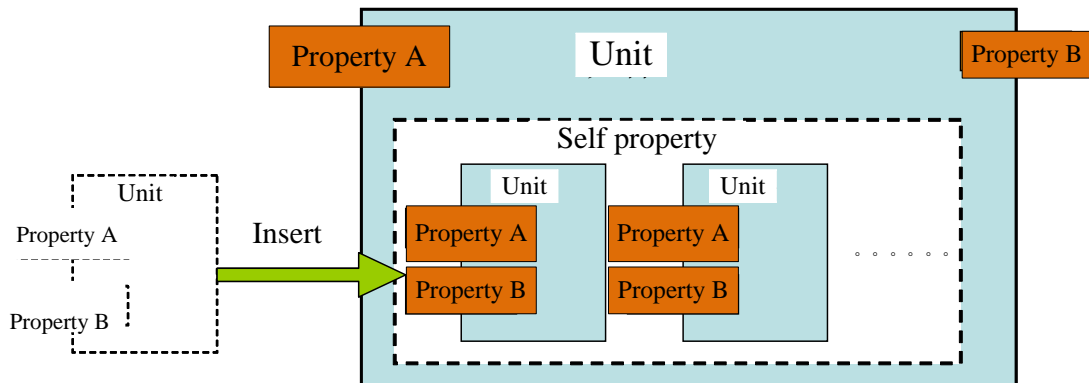



Description: "Insert unit" operation is generally right to “switch” 、"IF" component making sense. These two components, similar to an empty box, you can insert into other components to become their "self unit", The two components, according to the logic function to execute “insert unit”。(About "switch"、 "IF" component , you can see the relevant section) When two or more elements combined, there is still generate "self unit" part in the "group" element

Example: Use “switch" unit to make a simple three state indicator, through the value of PSW300 to change the state

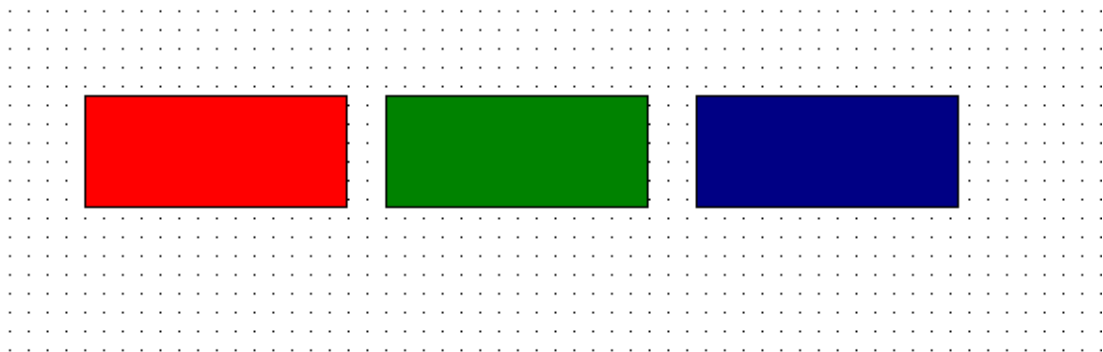
- ① Put three rectangle  on the screen, separately filled with red, green, blue three kinds color. As shown below:



- ② Put one “switch”  , one “read”  on the screen, to read component , point object to PSW300, as follows:



③ Box select them, right-click to pop-up the advanced dialog box. As follows:

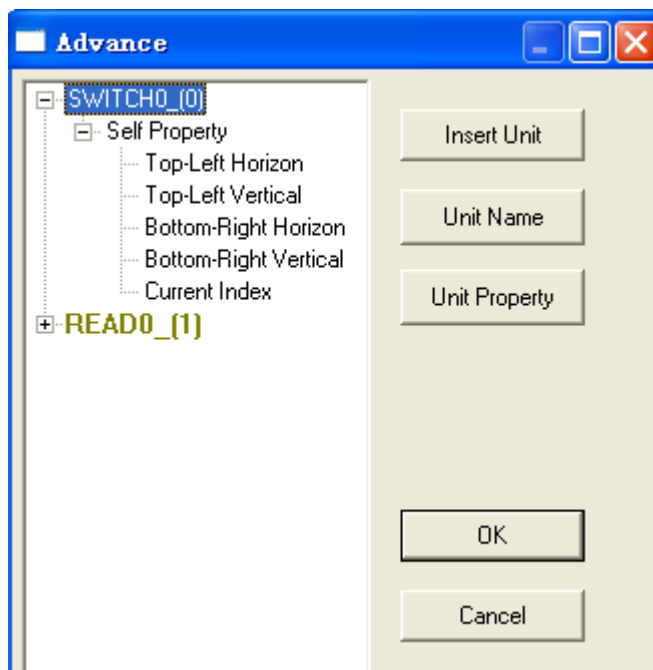

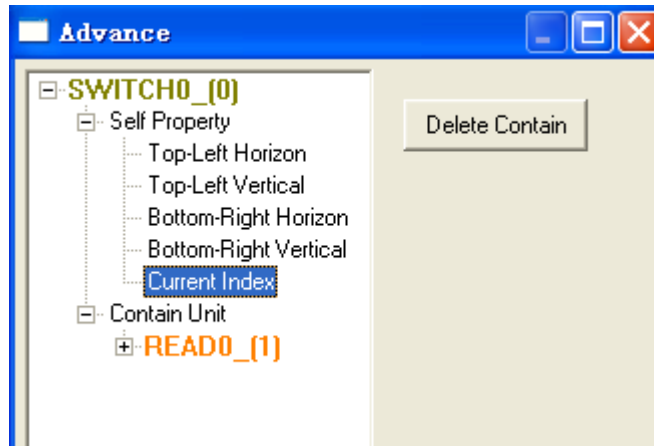

- “current index” of switch property contain “Read”.(Operation method can be seen in the "property contain" section)

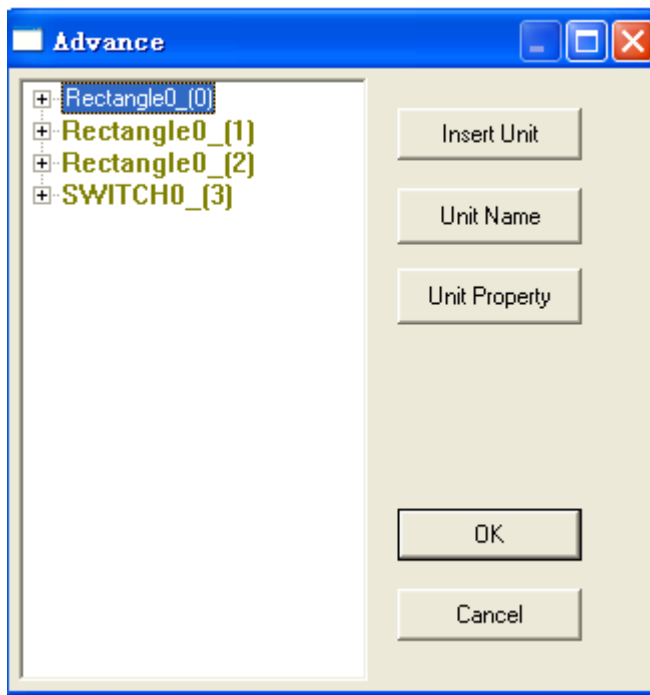

- ④ Box selects "switch" and the three rectangles, stacked them together, right-click bring up the "Advanced" dialog box.

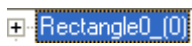

- Insert one rectangle into "switch" unit.

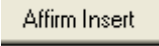
Steps: select  ---click  button—select  --click 

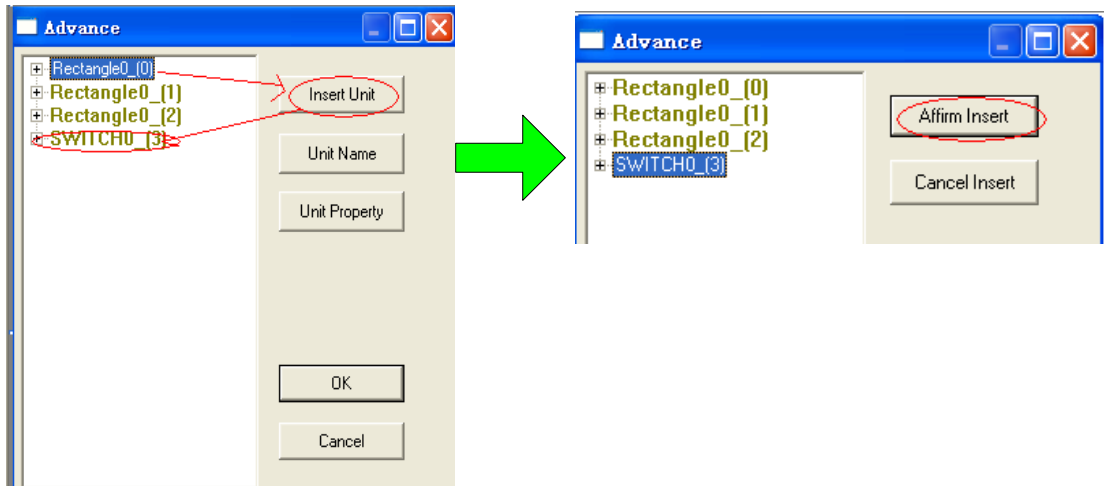

Also do the same for the rest rectangles' insertion.

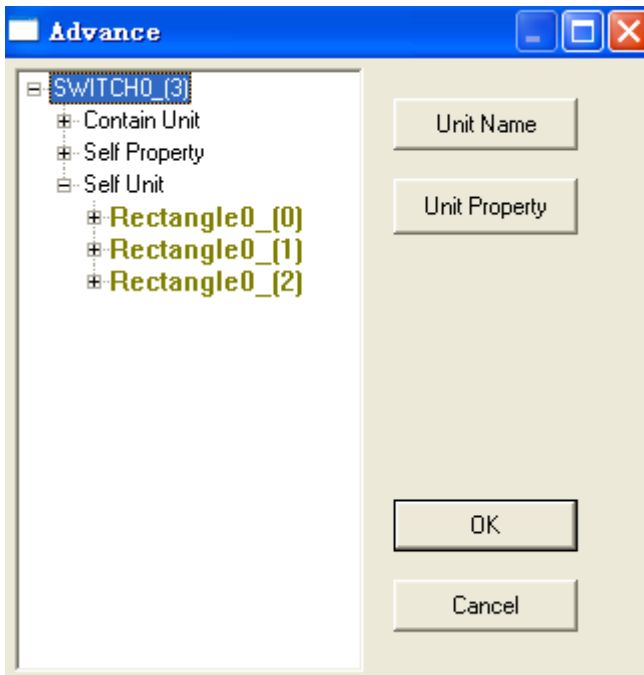

You can see, under "switch" more than a "self unit" part, self unit is the part to constitute the "switch" component.

After the completion of the dialog box, click the "OK" button to exit.

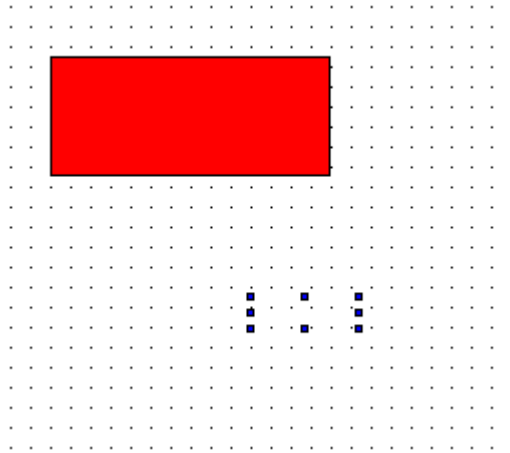

- ⑤ Put one “digital input”  on the screen. Point object to PSW300. as shown below:

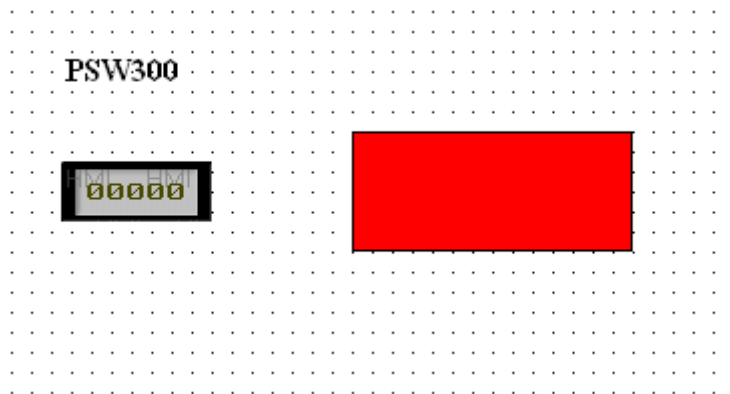

- ⑥ Click “offline simulation” to observe the effects:
 Modify the value of PSW300 (0, 1, 2), the three rectangular will switch display, showed to be a simple three status indicators.

PSW300



PSW300



4. Component function Introduce

4.1 Overview

This chapter introduce the function and usage of the advanced function part , and. each component with a small routine as instruction to understand. (note: some parts due to its function that user inconvenience using , so the introduce are omitted here),

4.2 Part Introduction

4.2.1 Switch component

Summary: The component is similar to switch (case) statement function of programming language, in engineering applications, often used with rotating animation, pictures switch and other parts to achieve flexible animations.

Through the tool bar component  to place it on the screen , right-click the component and select “advanced” , the advanced property is shown below :

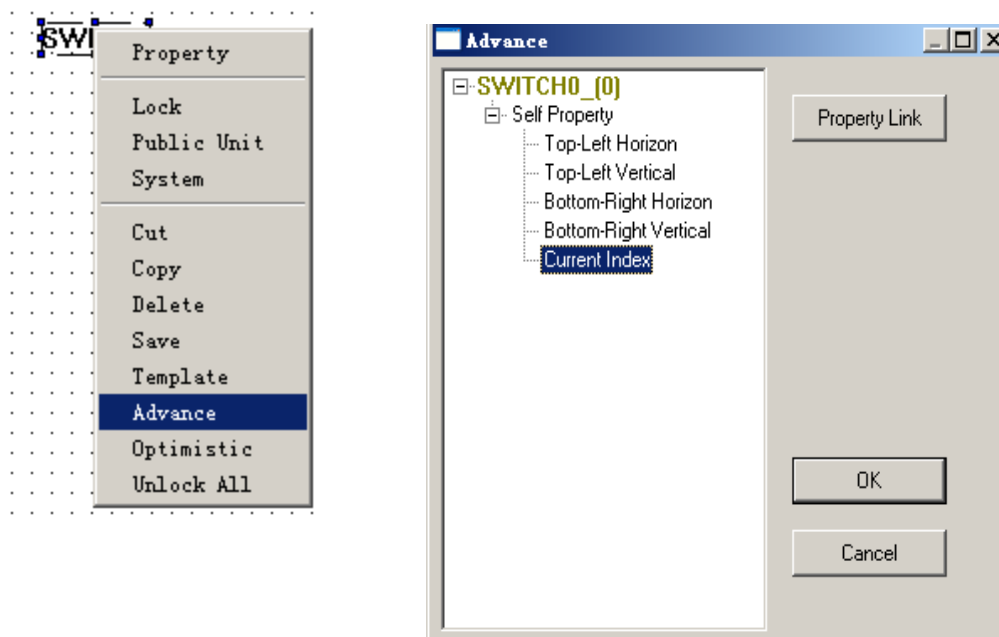

- Through “current index” and other part’s “property contain” to edit advanced functions, Based on “current index” to operate pictures switch and other operations.

Example: Switch component's image switch based on rotating animation

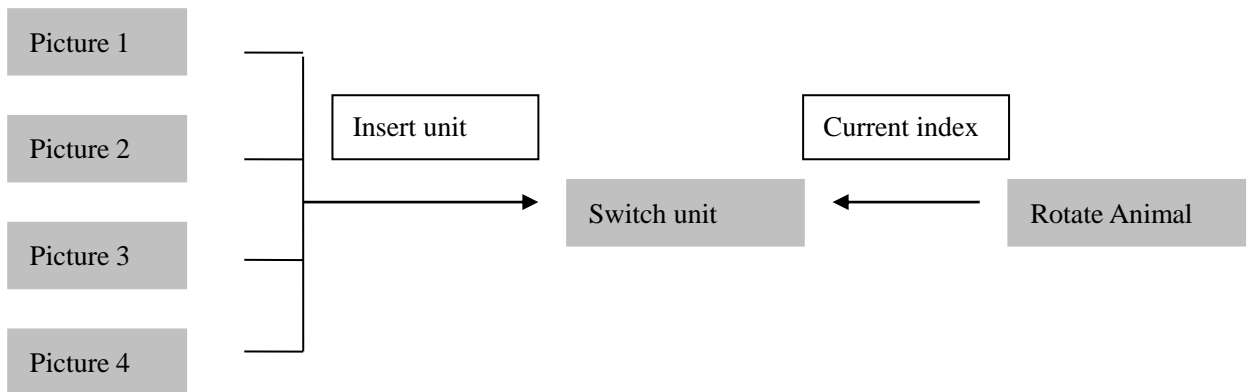

In this case, will achieve the following switch between the four images:

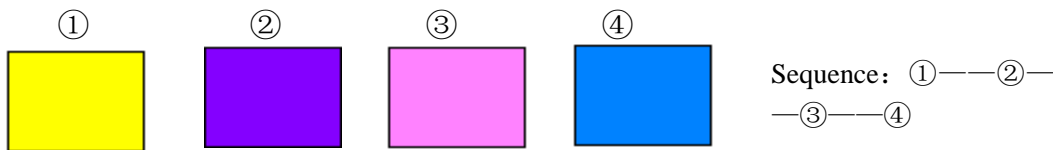

Implementation steps:

Step1: Add pictures to switch component's "self unit", can be achieved through the following two ways:

Method 1: According to the stacking order added to the Switch :

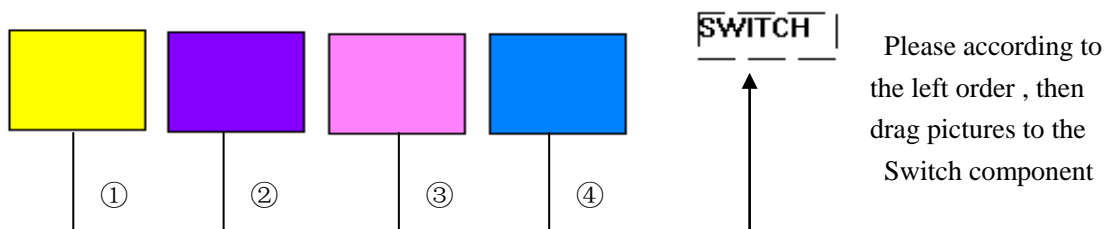

The following dialog box will appear, select "OK" to confirm the operation. Add complete, as shown on the right:

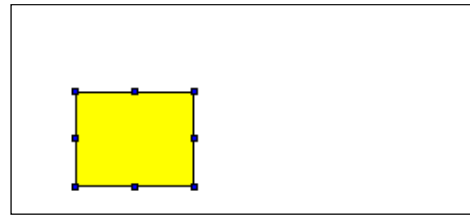
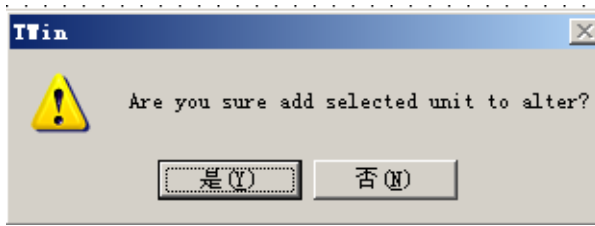

At this point, open the advanced function property , can be observed switch contains four components: rectangle 0_ [1], rectangle 0_ [2], rectangle 0_ [3], rectangle 0_ [4],

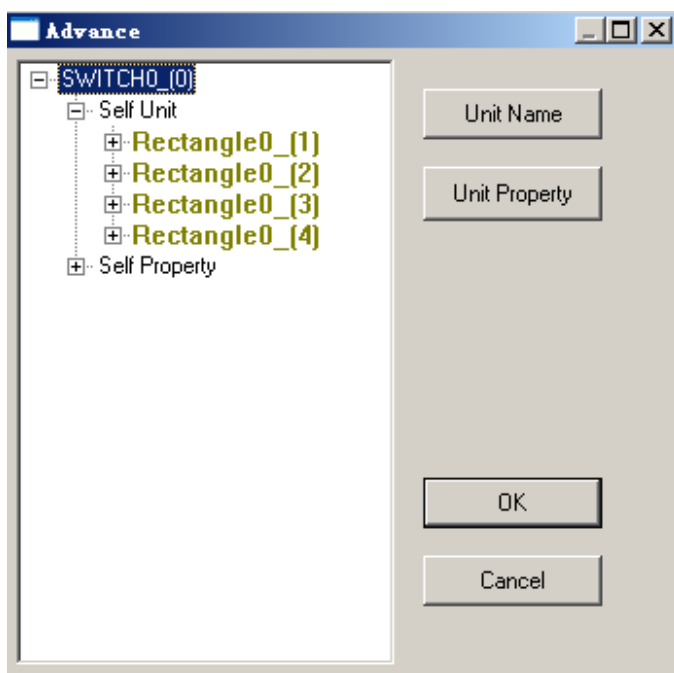

- Switch component's self unit with the dragging order, include rectangular 0_ [1] to the rectangular 0_ [4].

Method 2: By "insert unit" to achieve adding "self unit" to switch

Stacked rectangular in turn to the same location, rectangular 4 in the top level, rectangular1 at the bottom, as shown in the left graphic , this time, select the graphics and switch component, open advanced property , as shown on the right:

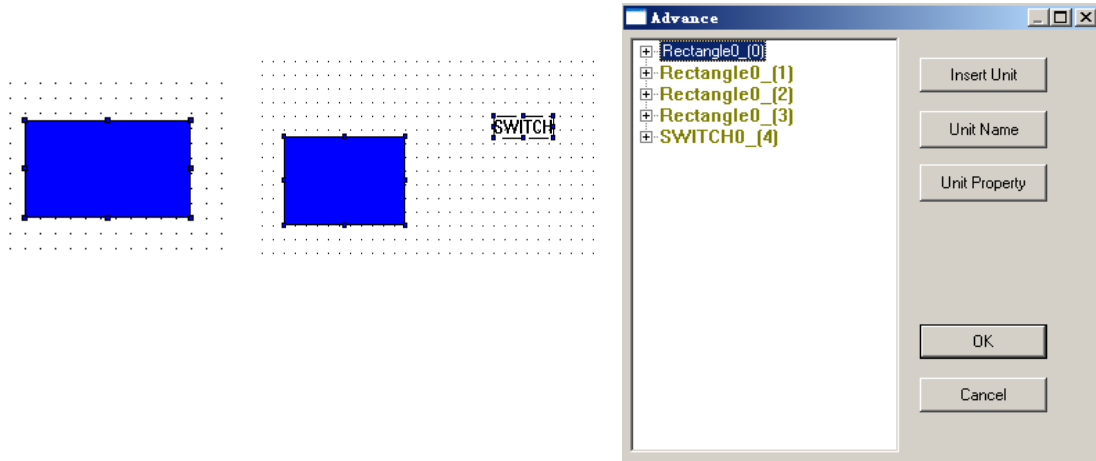

Please insert unit with the following order:

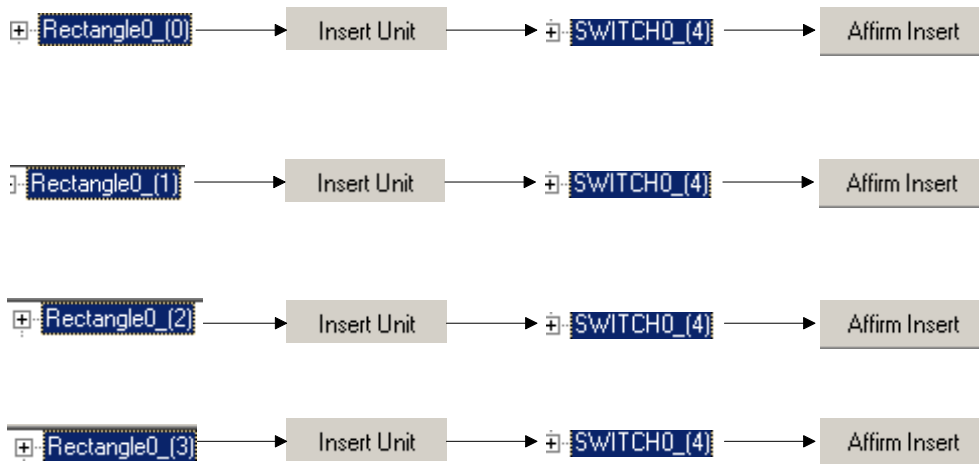

At this point, complete the adding of switch's "self unit".

Step2:

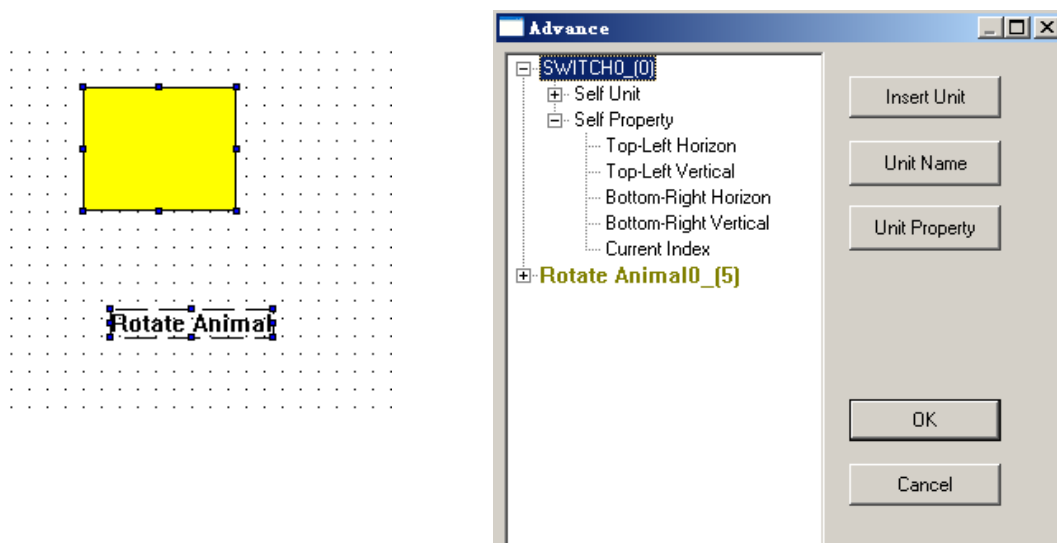

Operate according to the following orders:

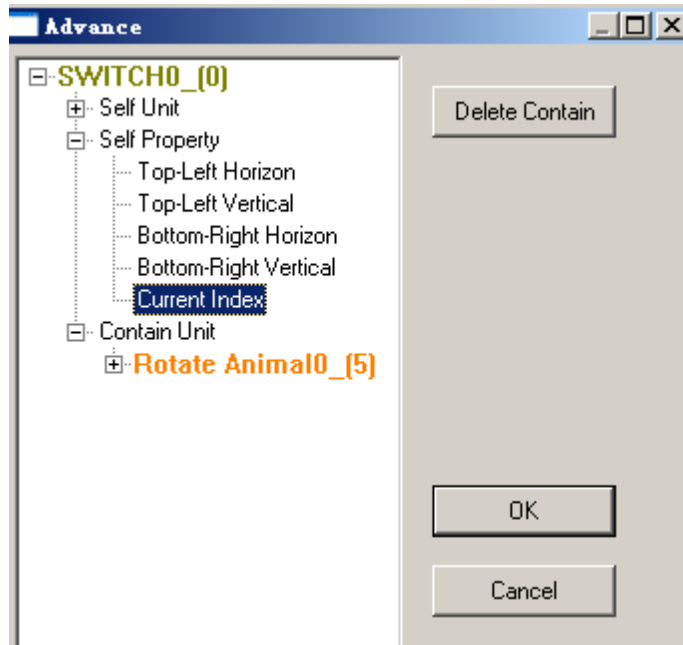
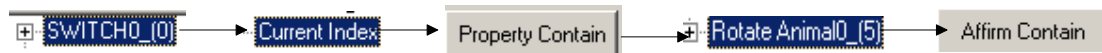

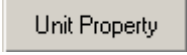
Step3: Select  **Rotate Animal0_5** , and then click  to modify the property, as follows:



- set period as 1000 , Namely, four pictures switch with 1000 milliseconds

- set **Start** as 0 , set **End** as 3

Step4: Function Simulation

Through the toolbar “off-line simulation” button to observe the effect .

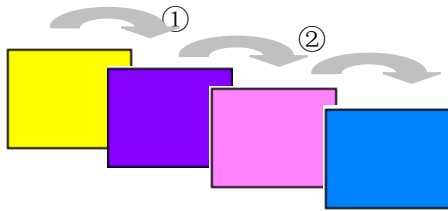

Through the simulation process can be observed picture switch from picture 1 to picture 4 , and the period is 1000 milliseconds.

Example 2: Text switch based on date change of register

In this example, according to the numerical changes in PSW300 register, to realize the different text display

PSW300 register

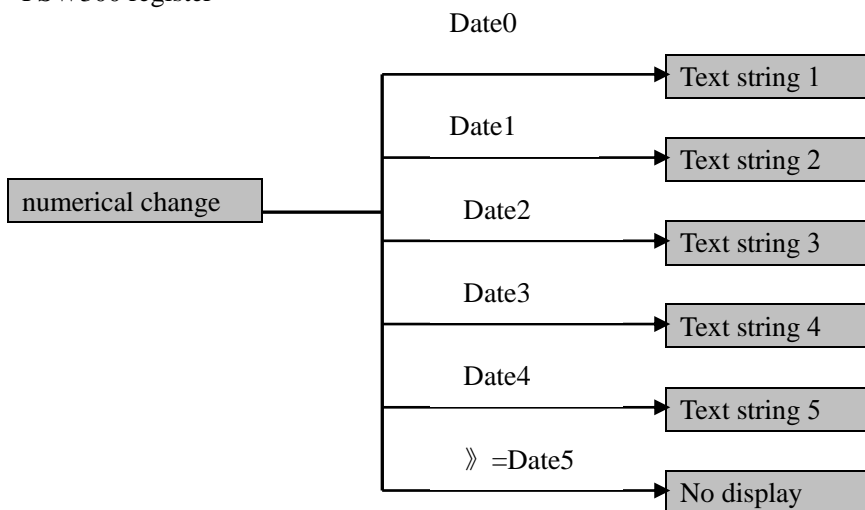

● In this example, when the date of PSW300 register changed, the display of text string also changed

Realizing method

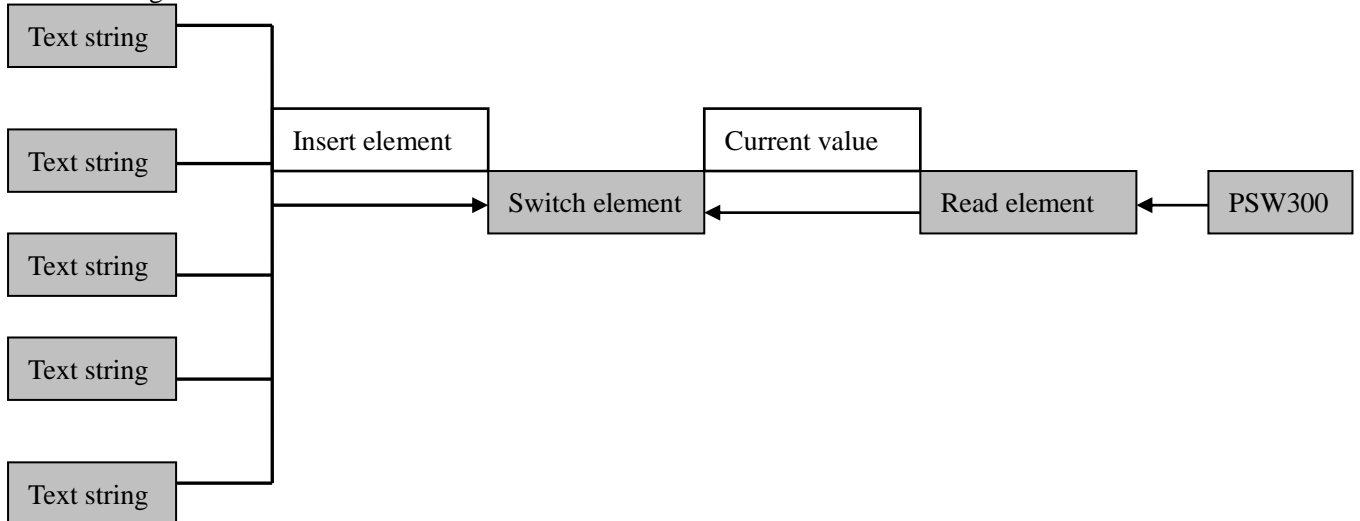

Realizing steps:

Step1: Modify read component's property , point object to PSW300.

Through toolbar part ——Read component“”, make it object point to PSW300,as the following:

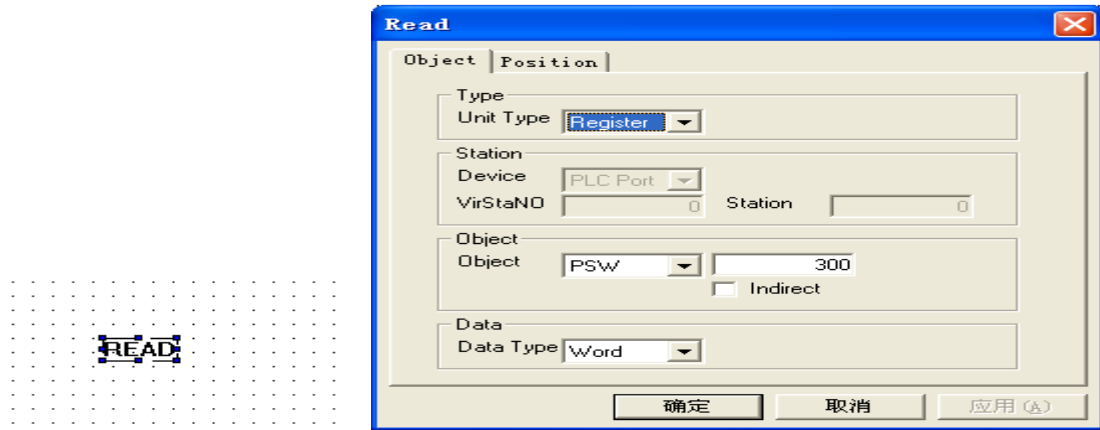

Step2: Add five text strings to switch component's "self unit"

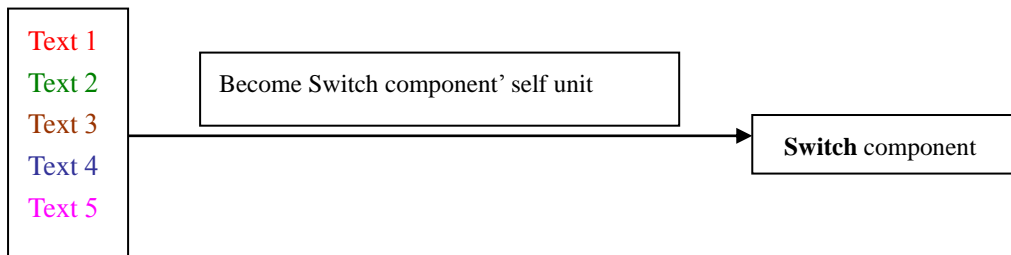

About how to add the five text strings to switch component's self unit, you can learn from the above example (Picture switch).

When complete the operation, the property is shown below:

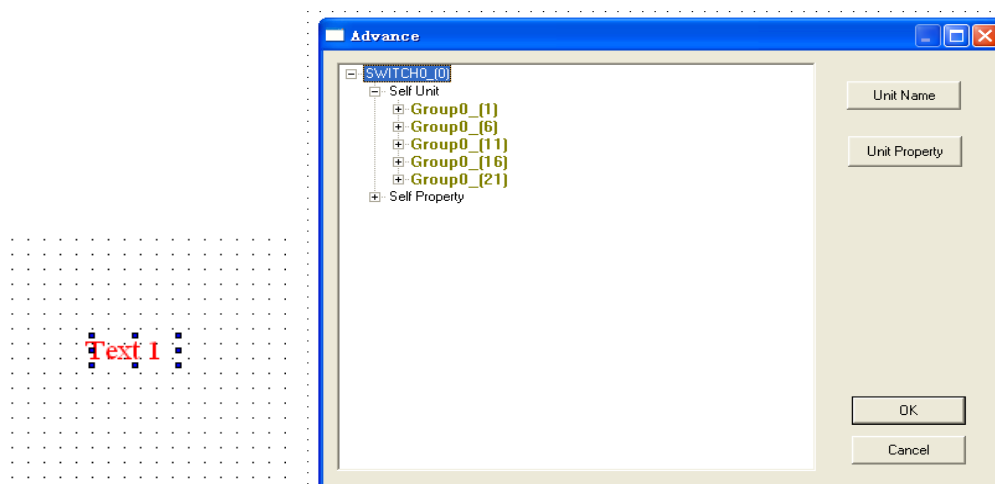

- Five text strings have been became to switch component's self unit

Step3: Switch component "property contain" read component

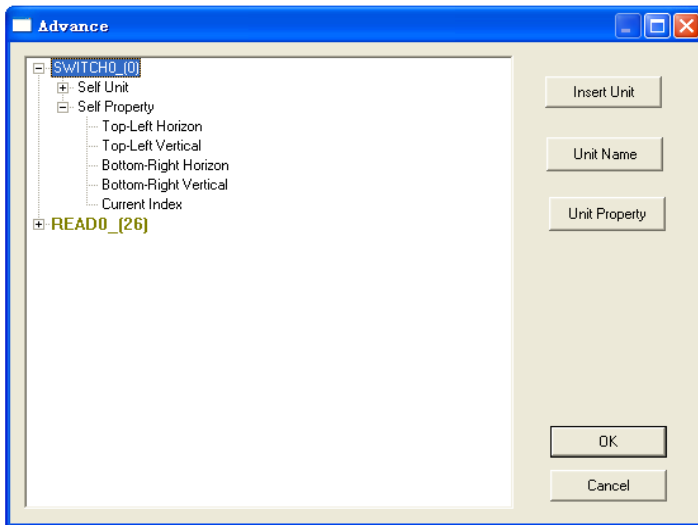
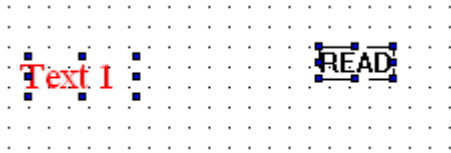

Step4: Via digital input component, make it point to PSW300.then via offline simulation to observe the effects.

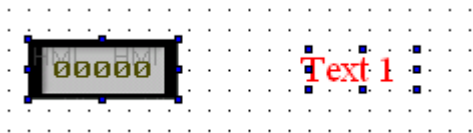

•After completing the picture, observing “digital input” component and switch component

The following are the effects of operations:

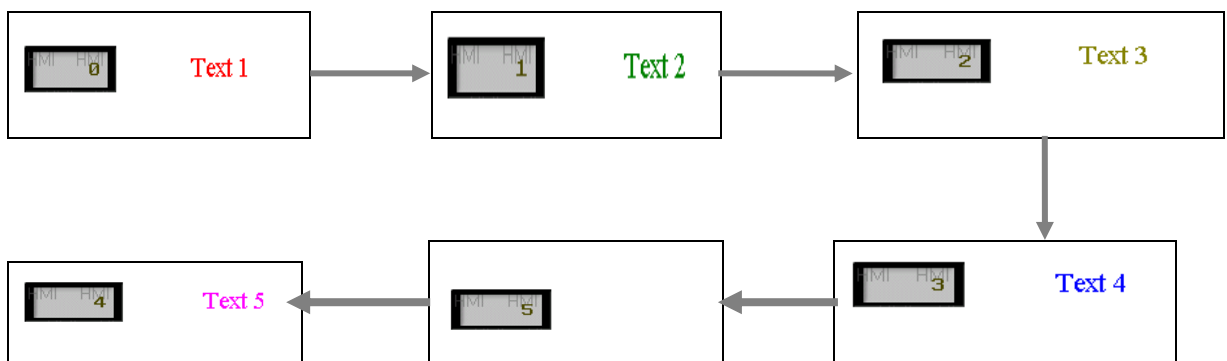

4.2.2 IF element

• Overview

The above description of the Switch component contains multiple branches, But IF component is a special case of Switch, can only contains two branches.

The principle and application of the component can be shown below:

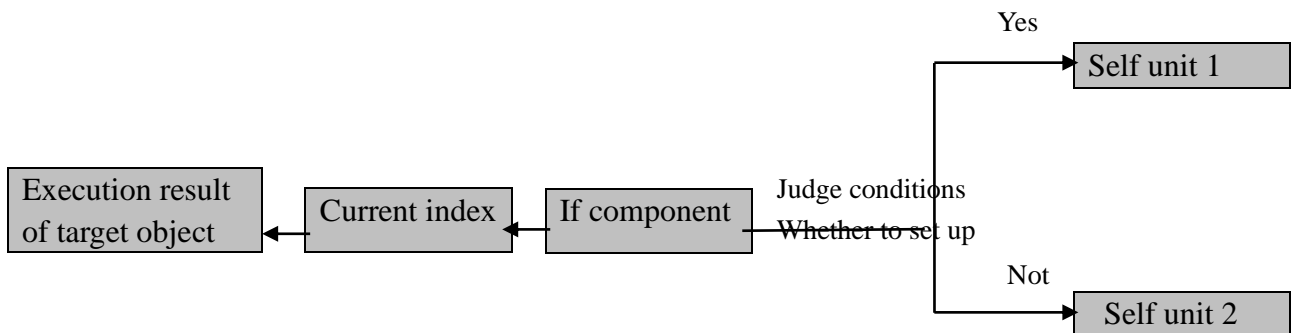

If component determines executing self unit 1 or self unit2 through the execution result of target object established or not .When the executive outcome is established (namely the return value is 1), executing self unit1; When the executive outcome is not established (namely the return value is 0),executing self unit2 .



• Routine

The following will be illustrated through the application of case :

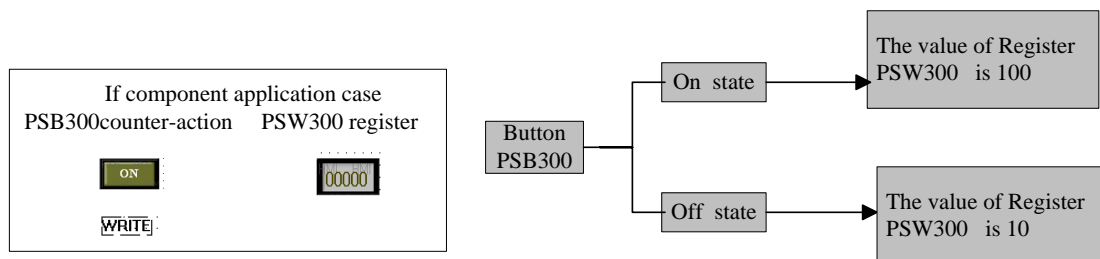
By anti-button to input definite value in the target register: when the button is ON state, the target register's value is 100; when the button is OFF state, the target register's value is 10.



Step1: The production of Data anti-button and digital input part

- Through the toolbar component ——lamp button, to execute PSB300 counter-action .
- Through the toolbar component ——Digital display, display the value of register PSW300.

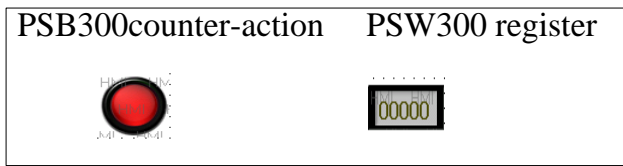

Set their properties as the following:



Step2: If condition judgment

Through the toolbar “read” component , point object to PSB300:

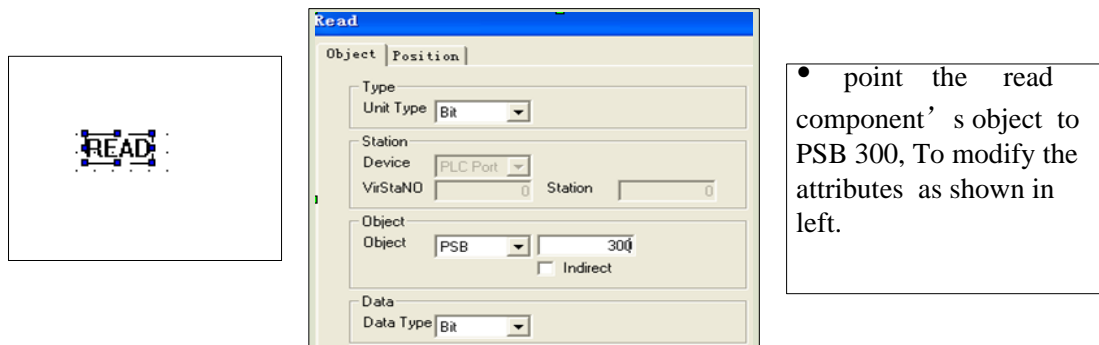

● The operation of current value of If component's property contain

Through the toolbar to place “”, select “If” and “read” components, make the following operations:

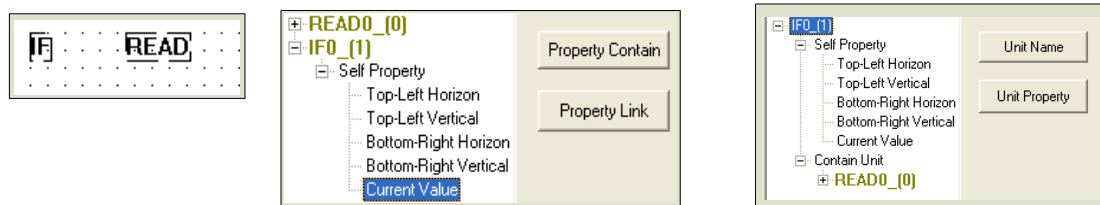

Please follow the following sequence to execute if element's property contain, after completion, as shown the above pictures:

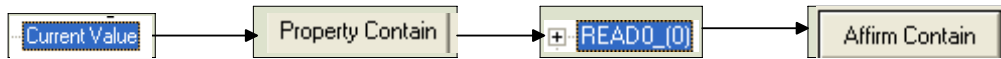

Step3: Implement If condition

The operations of write when If condition is established : through the toolbar “write” element—

—  , object pointed to PSW300,set date as 100.

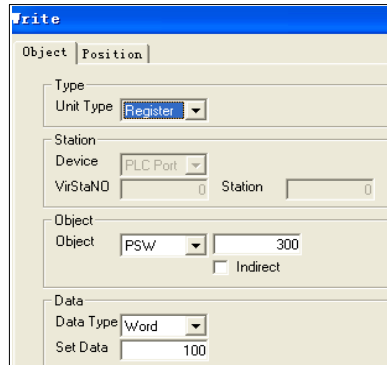
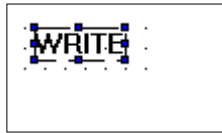

●modify the write unit, object is PSW300,date is 100

If condition isn't established, the operations of write are: through the toolbar “write” element—

—  , object pointed to PSW300,set date for 10.

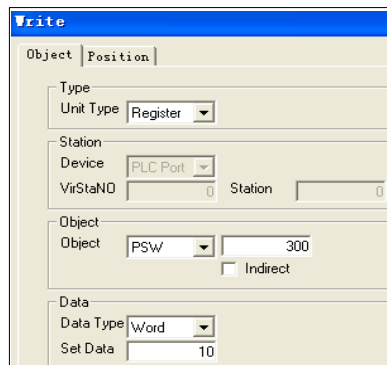
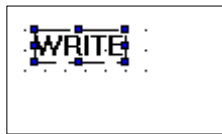

●modify the write unit, object is PSW300,date is 10

Adding the two “write” components as If component’s self unit, according to the following sequence:

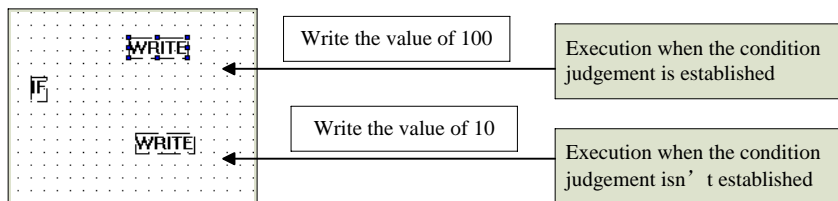

Please according to the application of above “switch” component to achieve their adding process. The results are shown below:

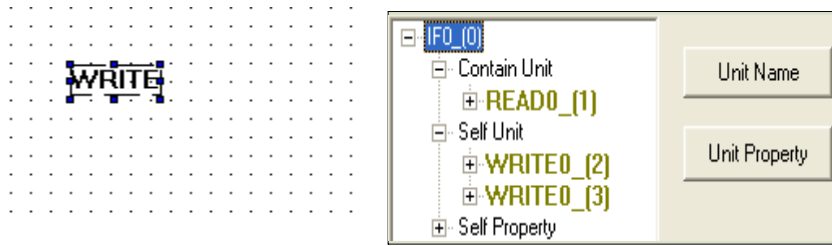

(4) Via offline simulation, observing the effect of operations.

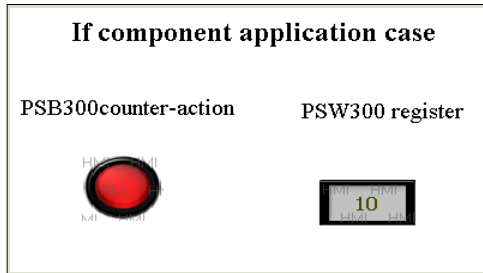

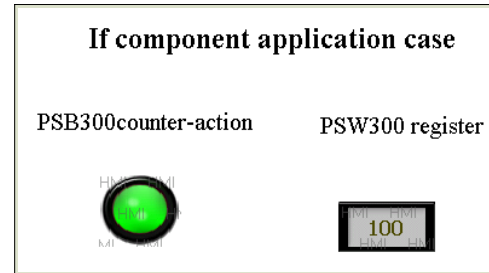

The digital display ,when PSB300 in OFF state



The digital display ,when PSB300 in ON state

4.2.3 Text

Overview: This component is used to display text or data, and similar to the basic component “text”  , The difference is that not only can display text, but also display data, character and other manifestations .

Through the toolbar component  , placing screen, their manifestations are shown below :

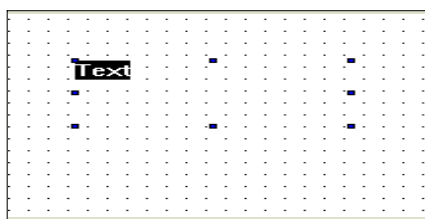

Advanced function "text"

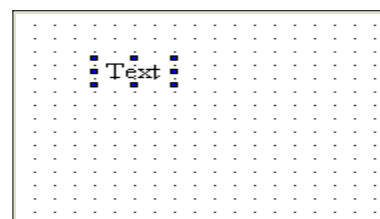

Basic function "text"

Double-click the advanced "text" part, the modify properties are shown below:

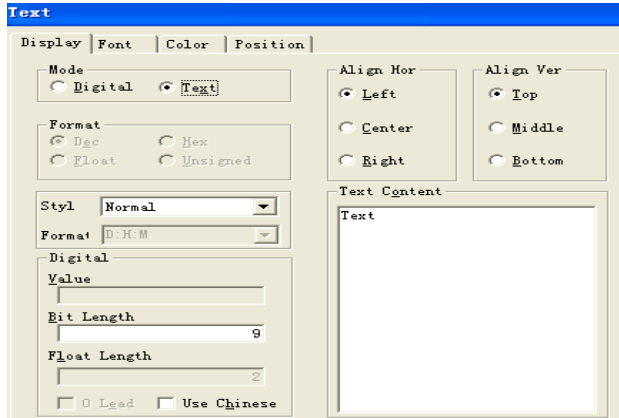

- display mode:exist “digital” and “text” two forms ,the “text” form include characters, Chinese and other various forms
- format:The contents are only "display mode" in the "digital" form effectively.
- special style :Include, "time", "normal", password " totally three data forms.

The following would be examples of "text" part under the form of the "digital" and "text":

- Shown as "Digital" mode:

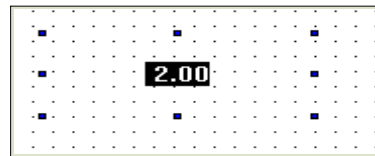
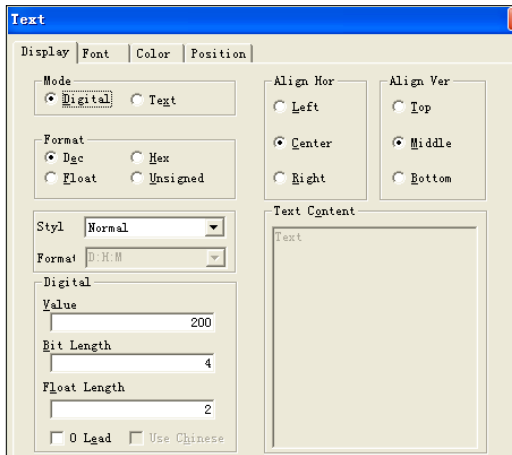

- Choose “digital” as the manifestation ,Data type is "decimal",Select digit to "4" bits, decimal digits for "2" ,When the input data is"200", the final data displayed as "2.00"

- Shown as "text" mode:

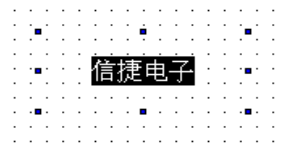
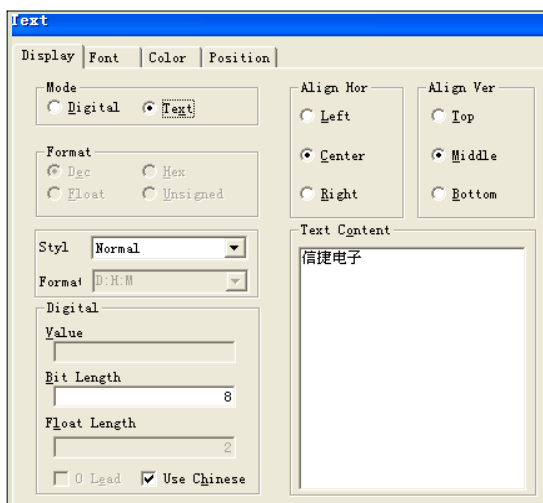

- Choose “text” as the manifestation ,in the "Special type", select "normal",At the same time check “use Chinese” ,When the text display as "thinget", the figure will be on display.

As noted, when under the “digital” and “text” mode , “text“ display can be set through the above means . but when “text” part as time to display, the following will through the display of

“hours : minutes: seconds” to explain:

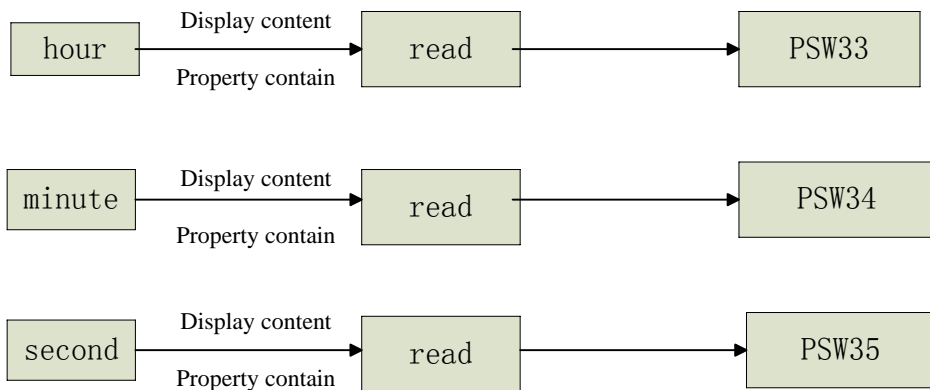

Step1: Put three  component on the screen , the property modification are shown below:

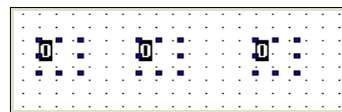
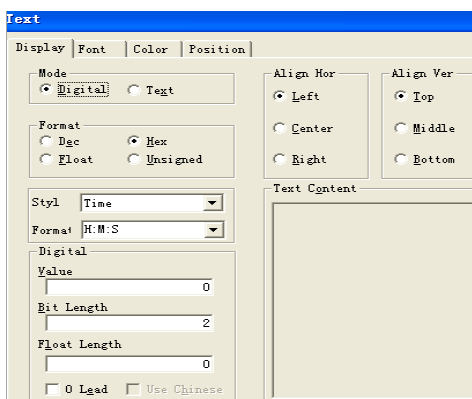

- **Display mode:** set as "digital" mode.
- **Style:** set as "Hex".
- **Special style:** select "time", and time format is "H:M:S"

Step2: To read the address of touch-screen's internal clock.

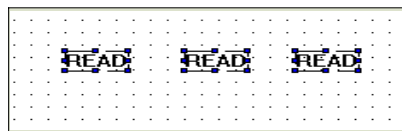
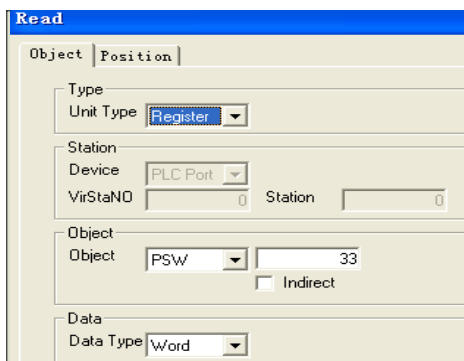

- Point register addresses separately to PSW33, PSW34 and PSW35, namely respectively point to touch-screen internal address "hour" register, "minute" register, "second" register.

Step3: Text display content point to the clock address

The following will be using "hour" property contain to describe the production process, "Minutes" and "seconds" of the production process is similar.

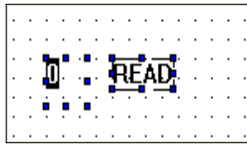

Select the “text” and “read” element right-click then choose “advanced”.

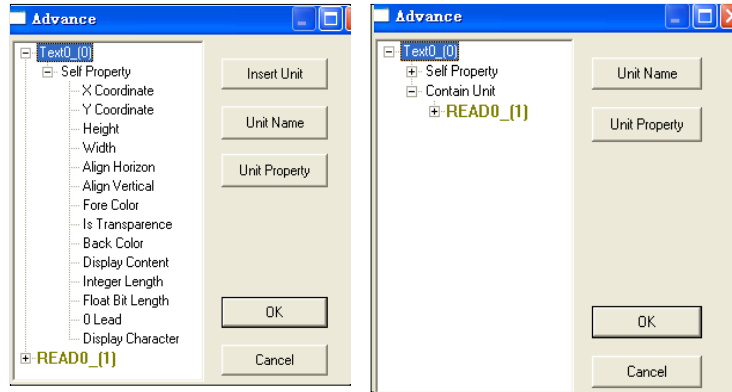

According to the following order to modify, after the completion of adding, as shown in the upper-right figure.

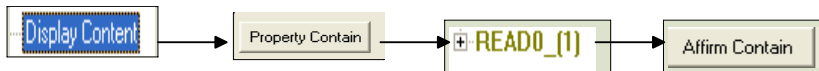

According to the above method for "minutes" and "seconds" property contain, the screen shown as the below - left figure, through the off-line simulation can observe the effects of operation, such as the below -right figure .

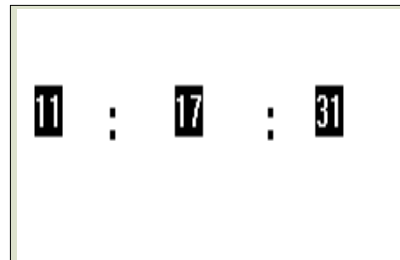
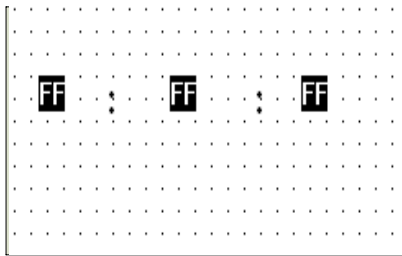

4.2.4 User input

Overview : Advanced function toolbar part “user input” component and basic function “user input” component are relatively, Distinction, advanced "user input" is the formation parts to basic “user input” component , mainly reflected in the performance of form and input return value.

Example: In the following case can observe the difference between advanced "user input" component and basic "user input" part:

- To advanced “user input” component : Input “1” to the digital input box which object pointed to PSW300.

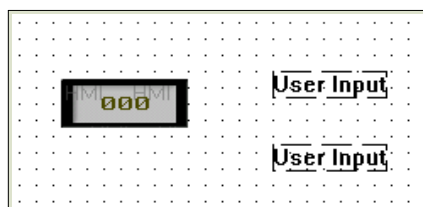

- To basic “user input” component:



Click “digital input” → click “1” button → click “ENTER ” button → finished

Application example:

Here are introduction of the completion process of the above-mentioned cases:

Step1: Digital input component, object pointed to PSW300

Through toolbar “digital input” component-, placed on the screen, point object to PSW300, as the following:

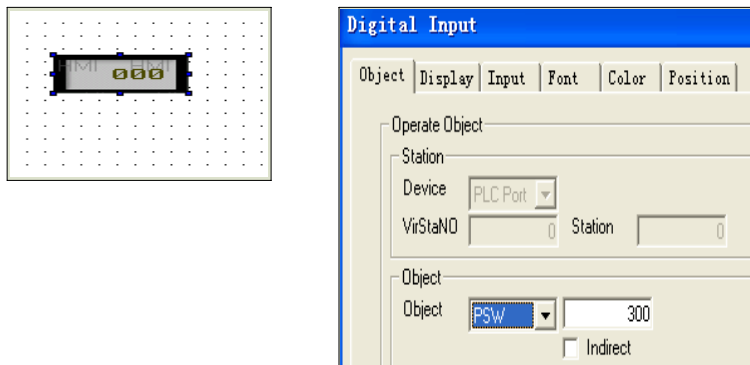

Step2: Click advanced function toolbar part “user input”, placed on the screen, as the following:

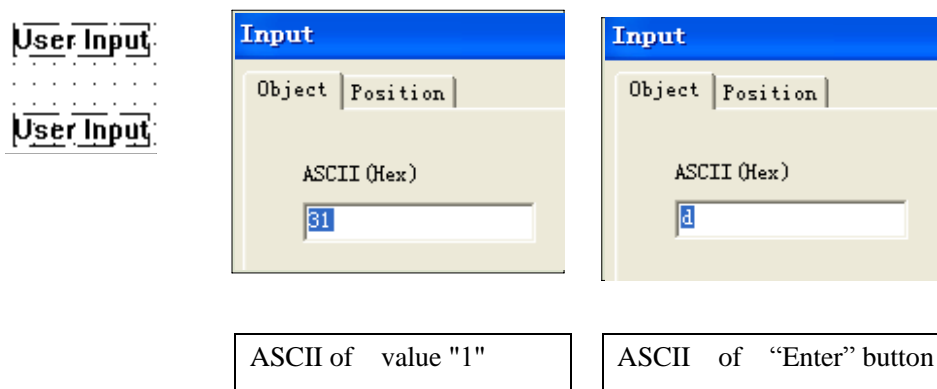

Step3: Function Simulation

Through the toolbar “off-line simulation” button, clicking the digital input box to set the date of register PSW300 to 1:

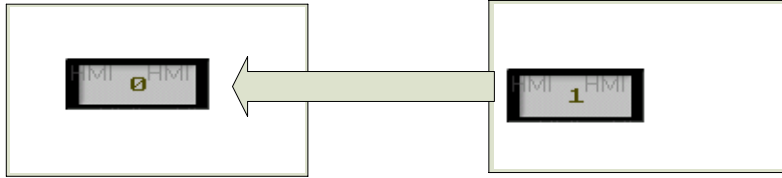

4.2.5 Screen jump

Overview: Advanced Function - "screen jump" component as the action component part, Click the Advanced toolbar component “”, Double-click to modify the property, as follows:

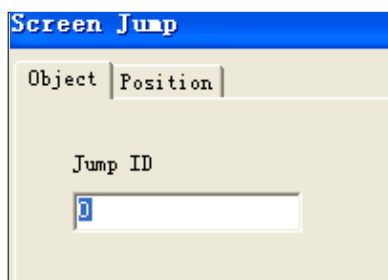

- Input the screen No. Jump in “screen jump”

Example: In this case, PSB300 is the basis for the screen jump, when PSB300 in ON state, will jump to No. 2 screen, when the PSB300 in OFF state, will jump to No. 1 screen.

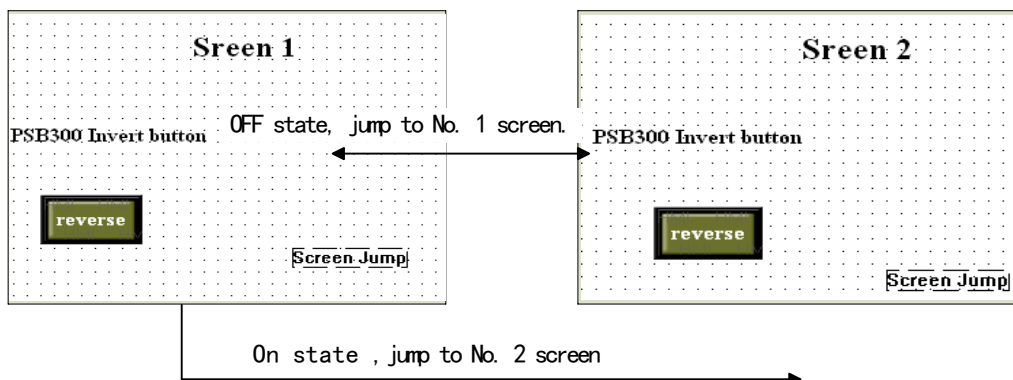

When PSB300 is ON, it will show screen 2, otherwise it is screen 1.

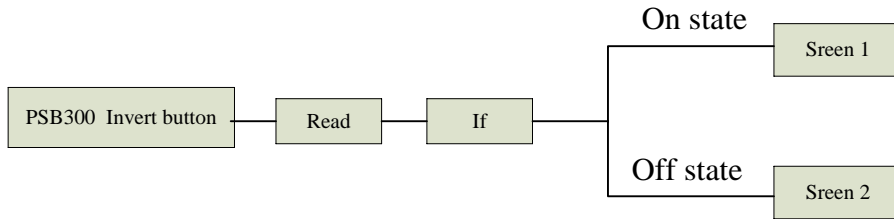

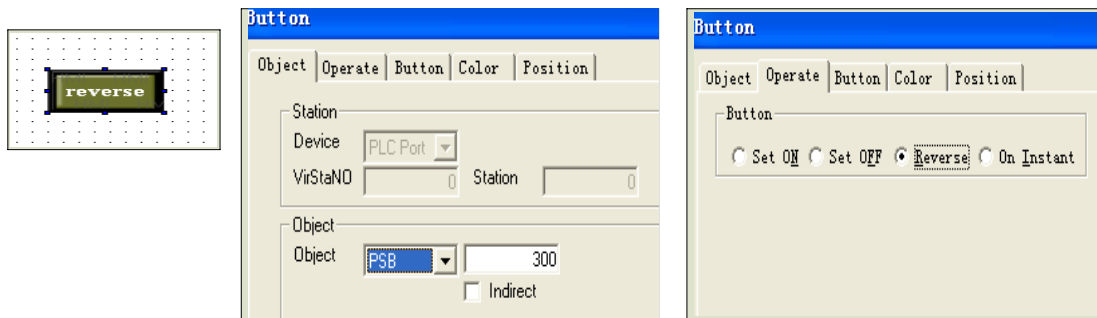

Step1: The production of screen 1

(1) Button production ,through toolbar unit  , point object to PSB300, as the following:



- point “Object“ tab to PSB300, select “operate” tab as “Reverse”

Step2: If condition judgment.

1. Put one "read"  and one "if"  components on the screen, as follows:

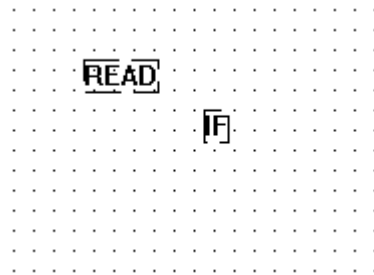

2.Double-click to modify its property , point object to PSB300.

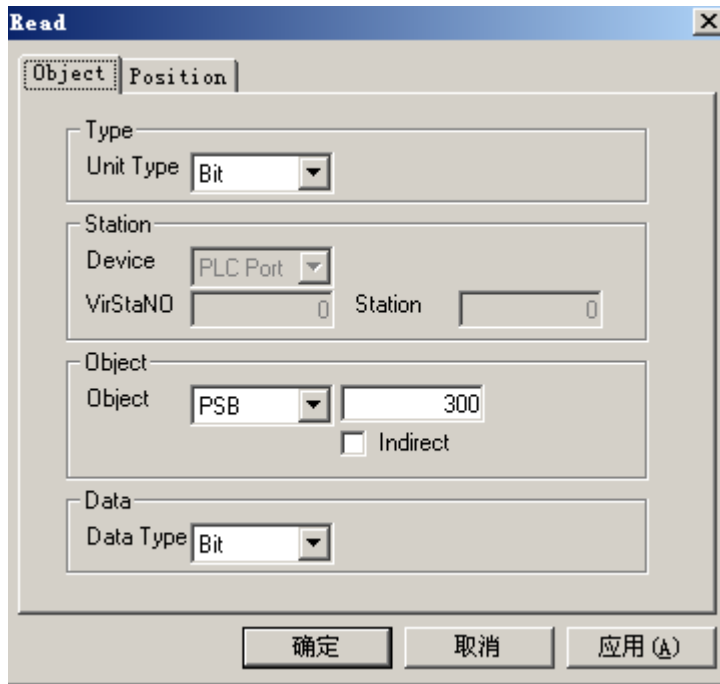

3. Add "read" as "if" components contain unit.

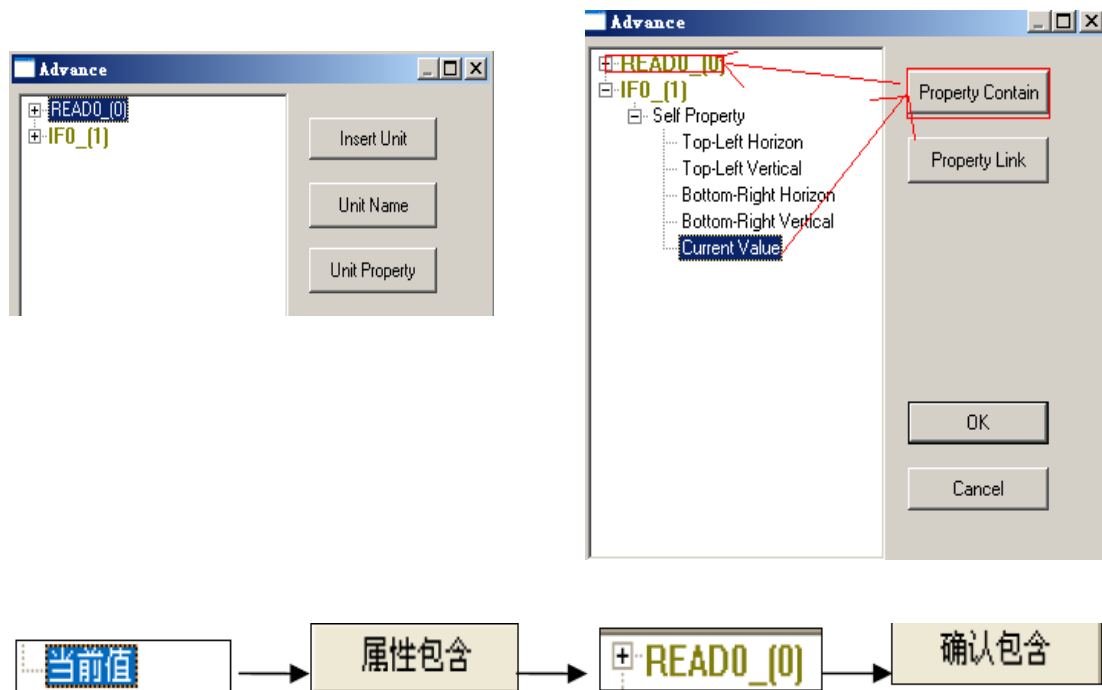

After property contain , the effect is shown below:

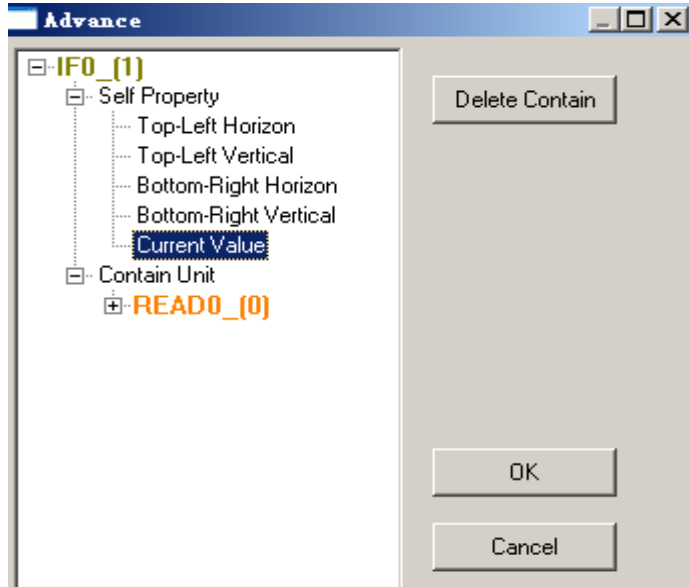

4. If Condition execution

● Through advanced tool bar , put two "screen jump"  on the screen, modify their properties, added as if component's self unit,

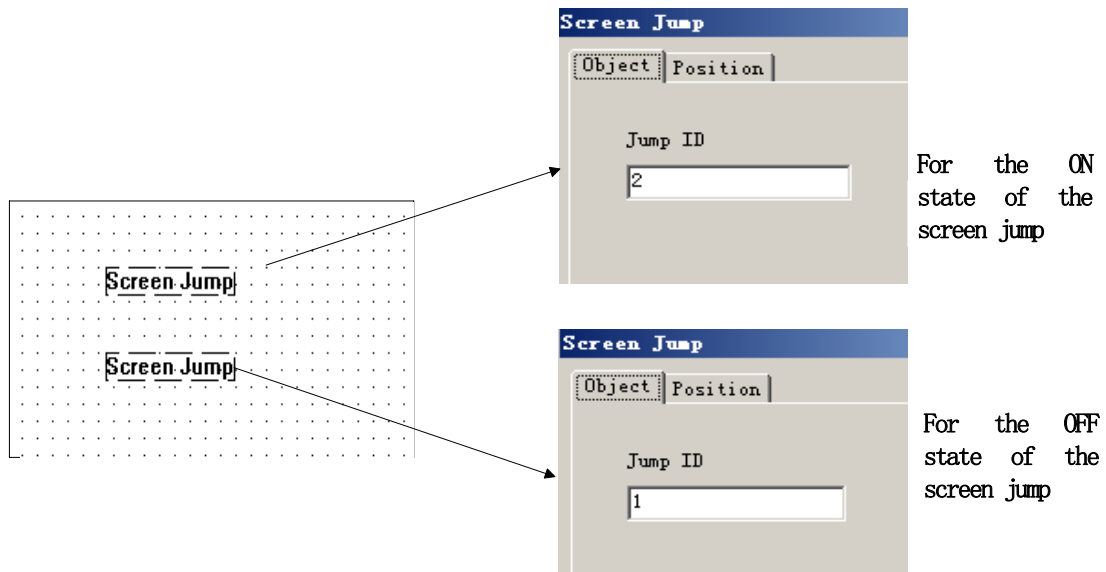

① Add "screen jump" as "if" component's self unit , Must be based on the following order :

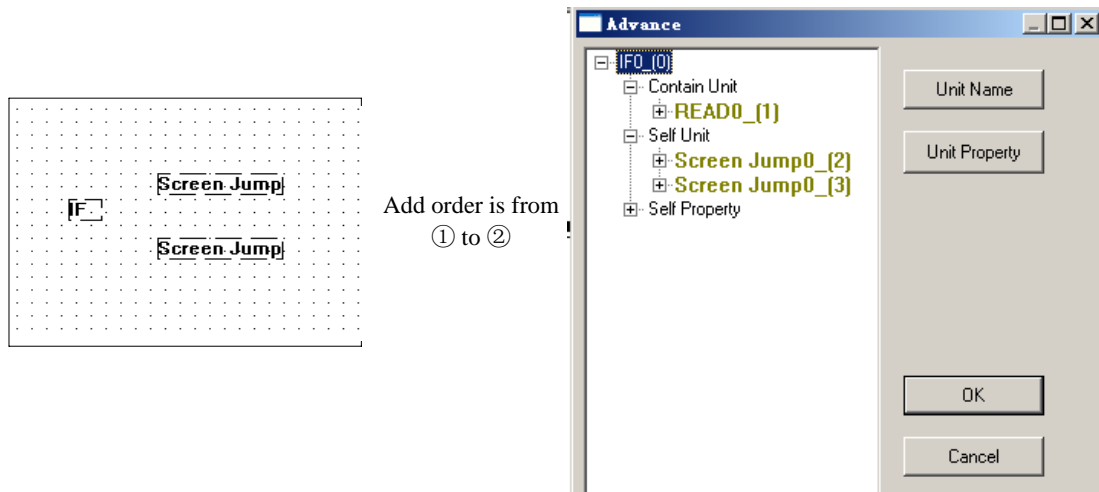

At this point, the production of screen 1 has been finished, as follows:

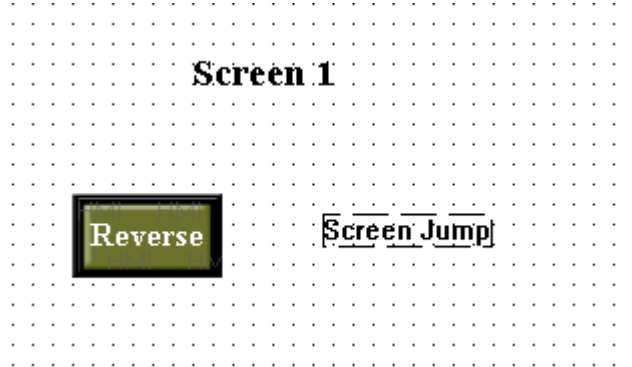

Step2: The production of screen 2

Similar to screen 1, you can directly copy reverse button and "screen jump" button to the screen 2, as follows:

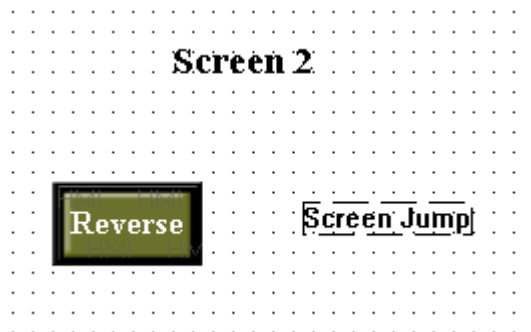

- Since the IF condition judgment between screen 2 and screen 1 are Consistent, so can be directly copied.

Step3: Through “Off-line simulation” to observe the Running effects:

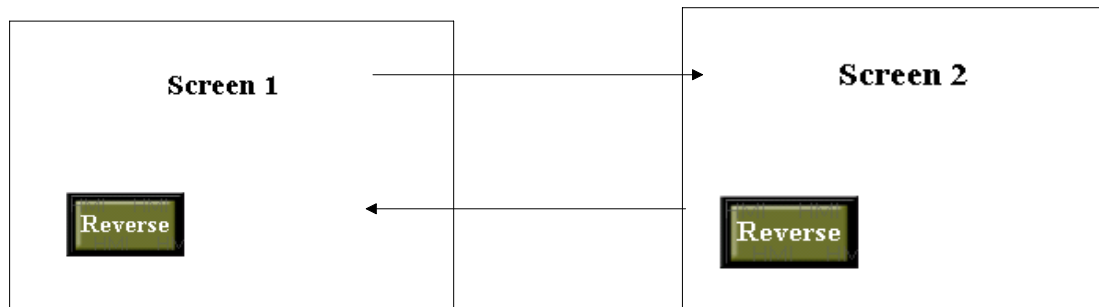

4.2.6 Password ? and Open password ??

Overview: In the applications of advanced function, "password" component used in conjunction with “open password” component, the former is to determine the competence and level passwords, the latter lies in the implementation of "open password" operation.

The functions are as follows:

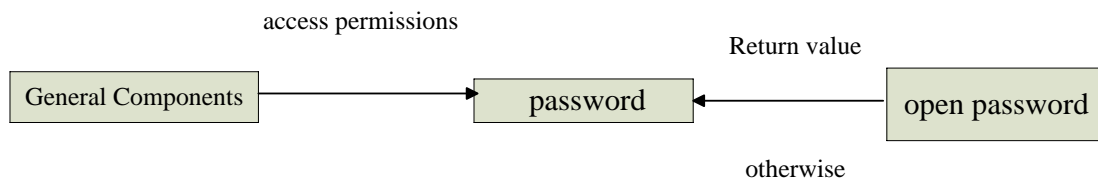

Example: The following through making screen jump button as example to describe the application of “password” and “open password”:

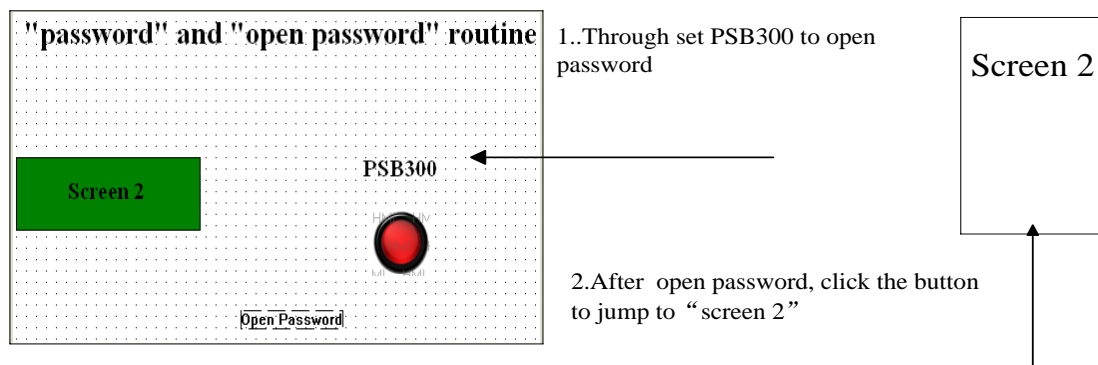

Implementation steps:

Step1: The production of “screen jump” button with the "Password" permission

(1-1) The production of key .

Placing advanced function part—— “ ” on the screen, as follows:

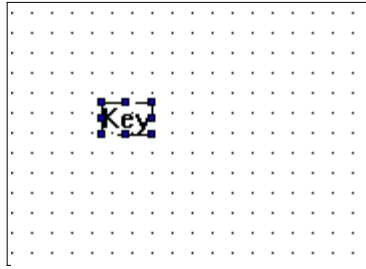

- Property is set to default values
- The four key states:
- State1: released
- State2: pressed
- State3: releasing
- State4:pressing

In this case, the operation corresponding to four states, which are as follows:

Status 1: a rectangular box with a screen 2

Status 2: NOP (empty operation)

Status 3: NOP (empty operation)

State 4: The Jump screens which through condition judgment to determine whether password returns value is 1.

(1-2) Judge if the password return value is 1.

Through advanced function parts to place “If” 、 “password”、 “screen jump” components. Then set "Password" component and "screen jump" part as the following:



Set password level as “level 1”

Set “jump ID” as 2

Operations according to the following steps:

① Add “Password” as "if" component's “contain unit”.

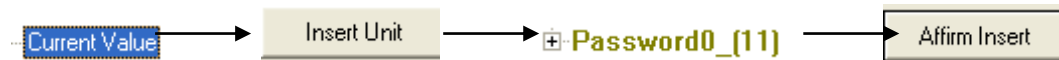

② Add “screen jump” as "if" component's “ self unit”:



At this point, can be observed “contain unit” and “self unit” of “If” component.

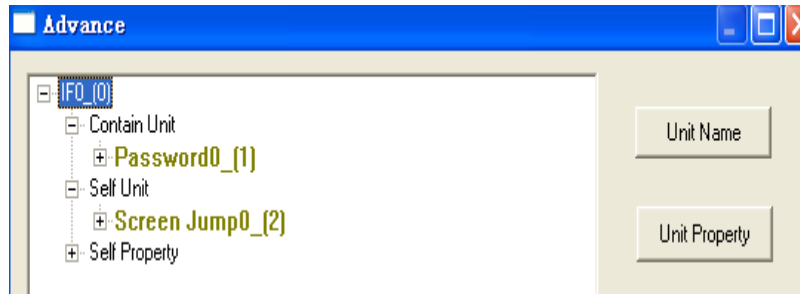

(1-3) Form to "screen jump" button

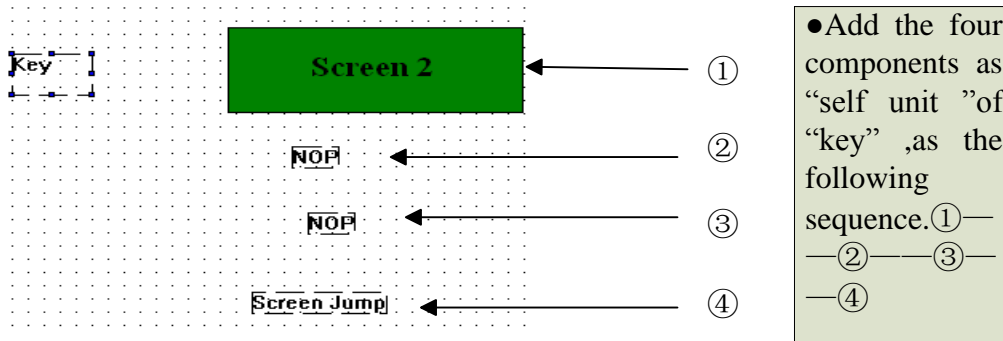

Complete setting, the screen is as follows:

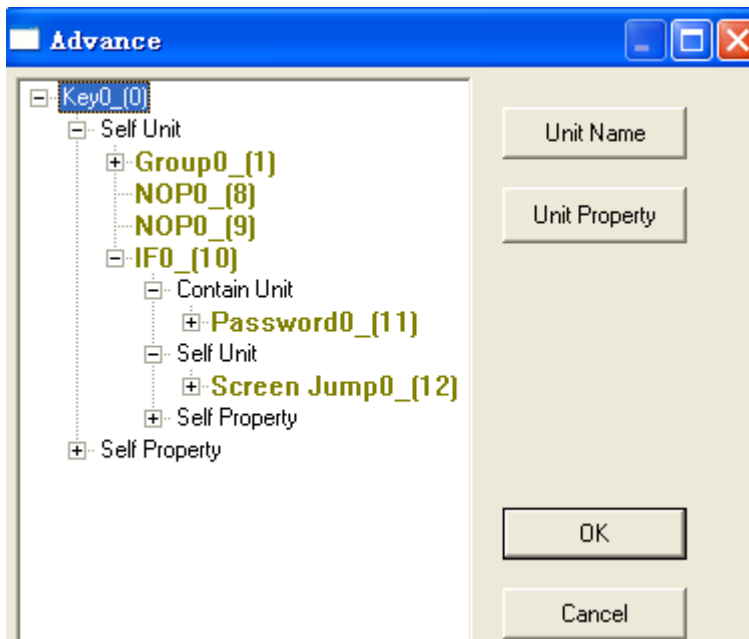

Step2: PSB300 in ON state of the implementation of "open password" operation.

(2-1) The indicator button which object pointed to PSB300, "button operate" is "reverse".

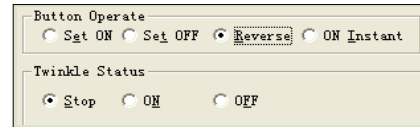

(2-2) PSB300 in ON state of the implementation of “open password” operation.

In this case, set the screen jump level as level 1, the password set in the “System Parameter” , in this case , the password is 123 , as follows:

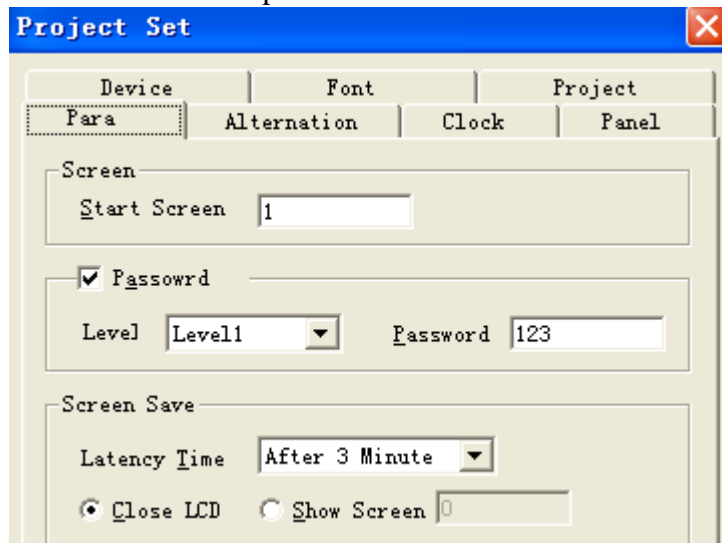

“IF” condition judgment, PSB300 in ON state of the implementation of “open password” operation:

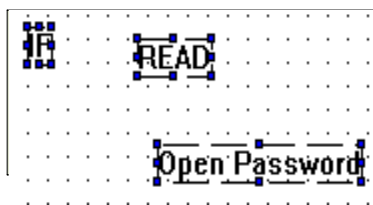

- Add “Read” as "if" component's “contain unit”
- Add “open password” as "if" component's “ self unit”:

“Read” property and “open password ” property are shown below:

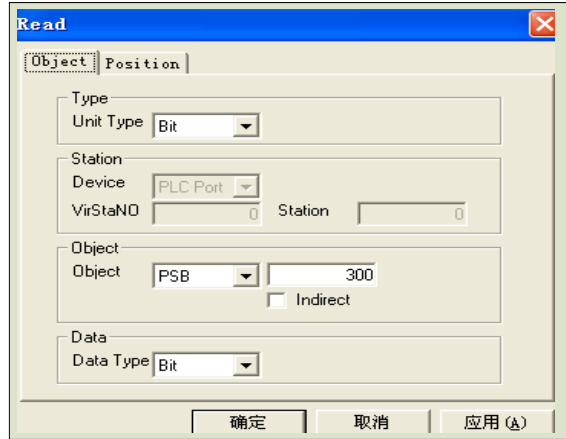
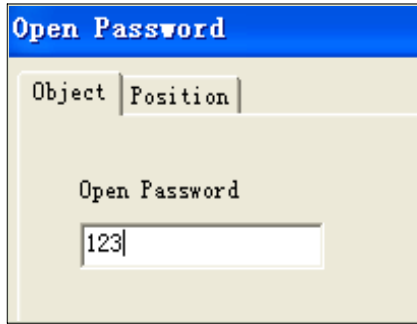



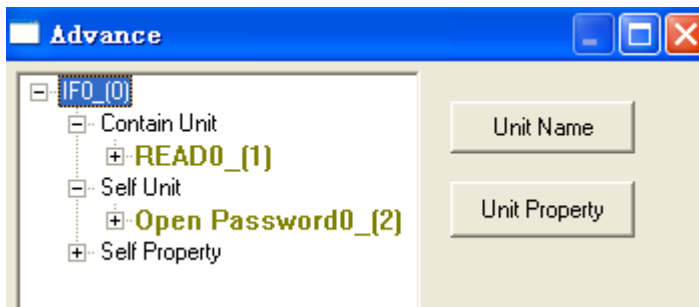



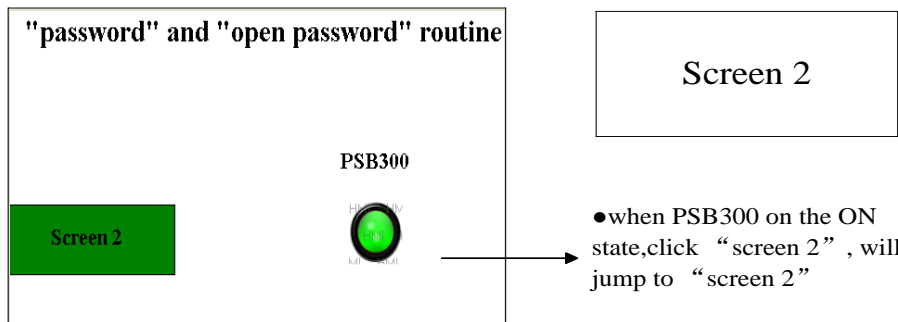
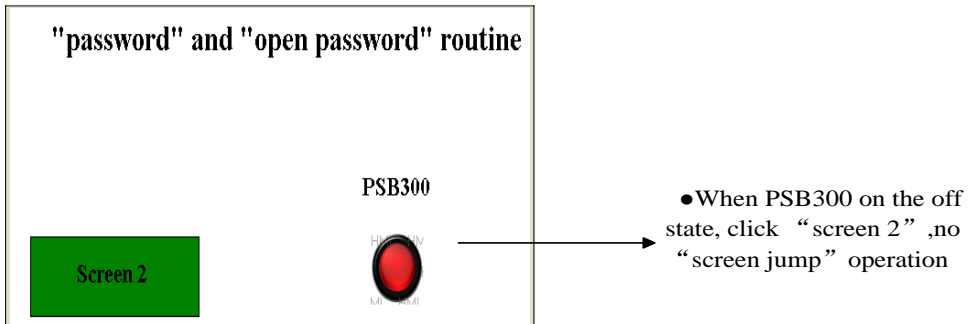

Advanced properties are as follows:



Step3: Through "off-line simulation" to observe effects, as follows:









4.2.7 Arithmetic

Overview: This section will introduce arithmetic  component of advanced instructions. Users can use basic parts -set data  to achieve +,-,*,/ operation, can also through advanced instruction  to achieve +,-,*,/ operation, but also the use of more flexible, Unlike the  button only limited on a variable and a constant +,-,*,/ operation, while advanced instruction  can through other advanced instructions such as read , write  to achieve constant and constant, constant and variable, variable and variable +,-,*,/ Operation, The following will introduce the function and usage of arithmetic  component.

•Routine

Step1: building a screen, placing parts on the screen

Building a new screen, placing the following components on the screen: three digital input , two texts  , one advanced instruction arithmetic , two advanced instructions Read , one Write , as the following diagram:

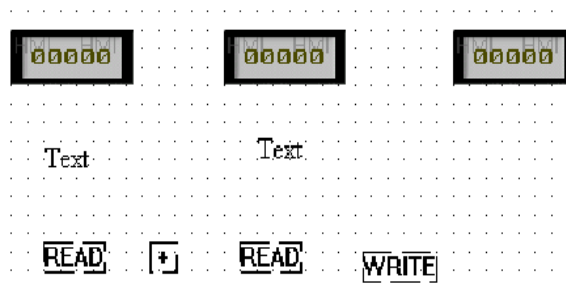

Step2: Basic components' properties modification

1. Digital input properties:

Double-click the left "Digital input", open the Properties dialog box, point object to PSW300, as follows:

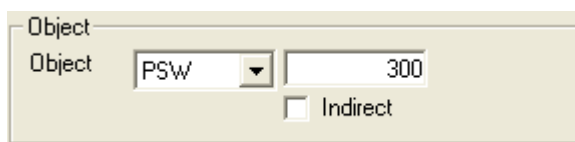

The same operations to the middle and right "Digital input", point objects separately to PSW301, PSW302, as follows:

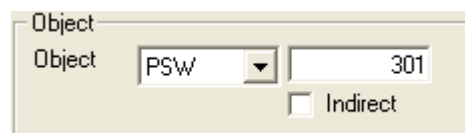



2. Text properties.

Double-click the left “text” to open the Properties dialog box, enter “+” into display content, as follows:



The same operations double-click the right “text” to open the Properties dialog box, enter “=” into display content, as follows:

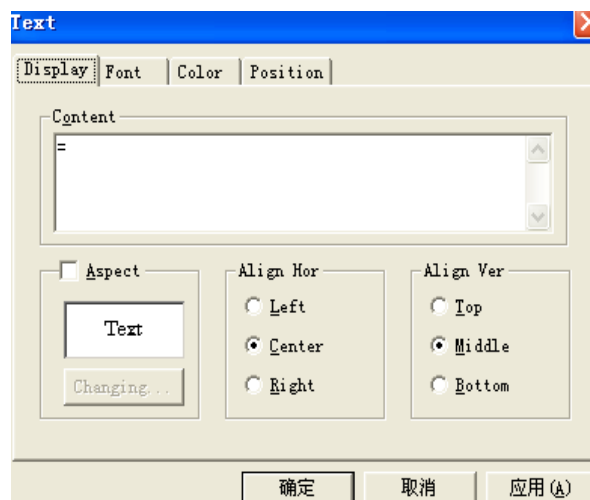

Step3: Advanced components’ properties modification

1. Modify the attributes of the READ

a. Double-click the left “read” component to open the Properties dialog box, here the modify type is register, object is PSW300, and the results are as follows:

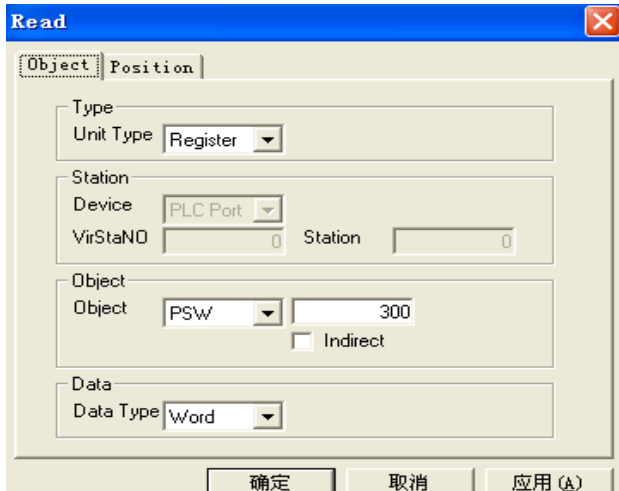

b. Double-click the right “read” component to open the Properties dialog box, here the modify type is register, object is PSW301, and the results are as follows:

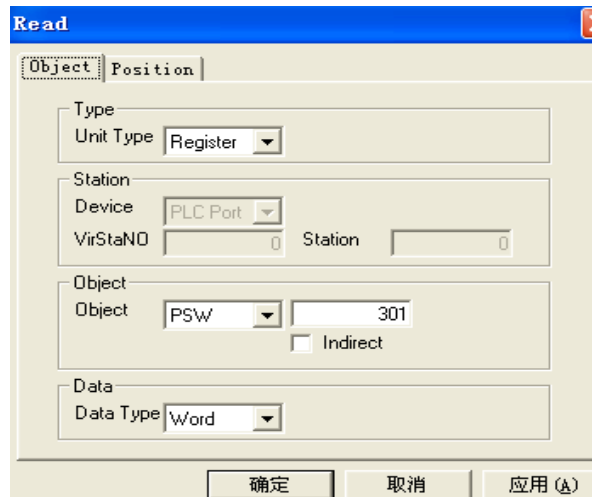

2. Modify the attributes of the “Write”

Double-click the “Write” component to open the Properties dialog box, here the modify type is register, object is PSW302, and the results are as follows:

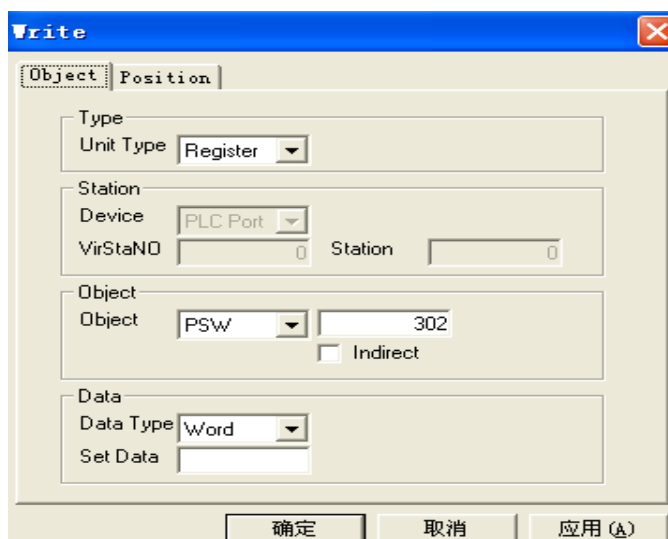



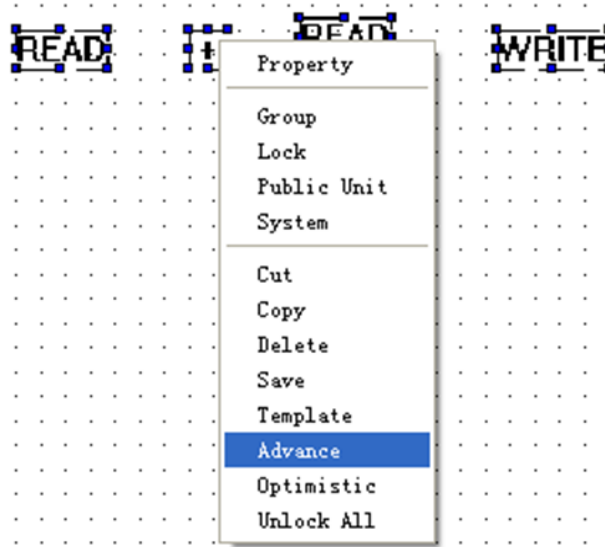

Step4: Advanced Operations

1. Select the two “read”, “write” and “+” at the same time, Right-click the selected area, Pop-up the following dialog box :

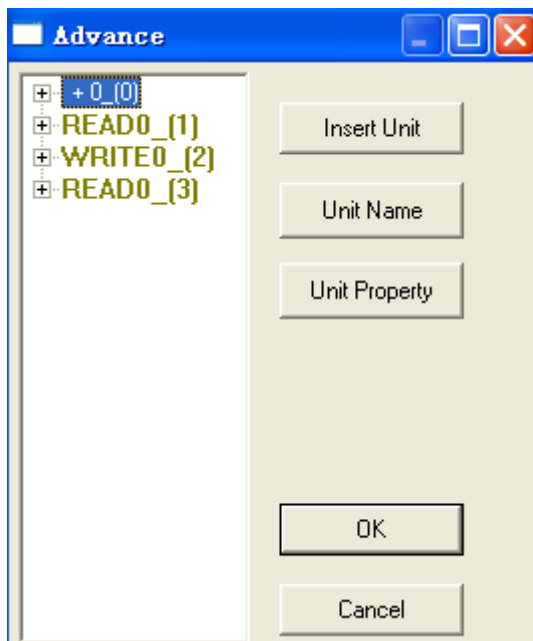

2. choose Advanced, advanced dialog box as follows:



3. Click the plus sign  in front of “write”, then click the plus sign  in front of “write-self property”, open its self property. as follows, select  :

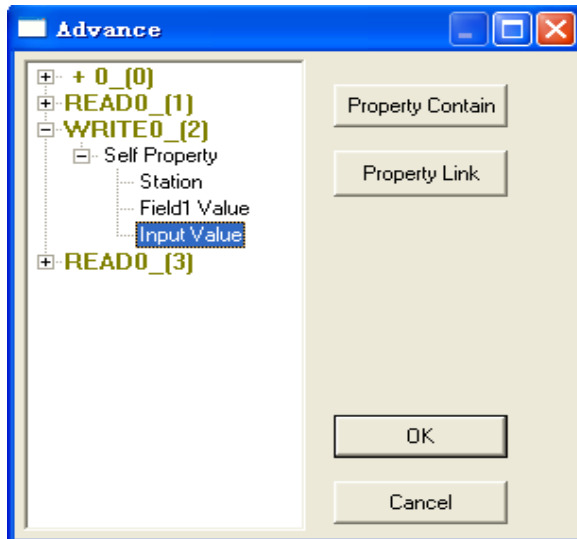

4. Click the right button **Property Contain** in the dialog box, the button will be grayed-out non-operational status, while text changed into “affirm contain”, as follows:

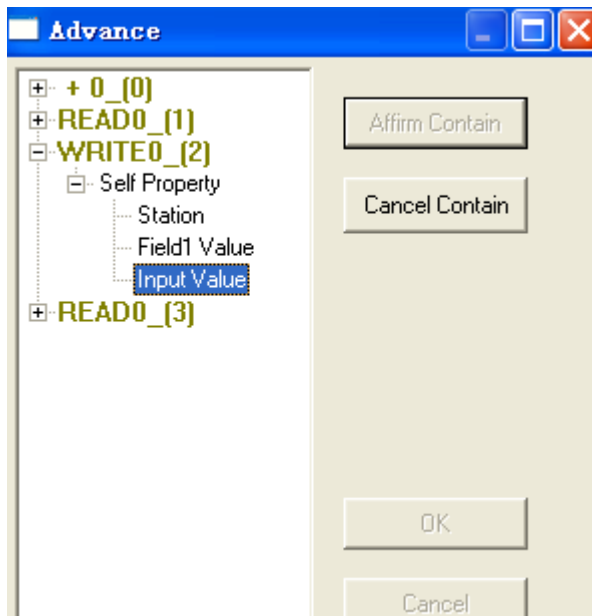

5. Select **+ 0_(0)**, button **Affirm Contain** immediately changed into operational status, as follows:

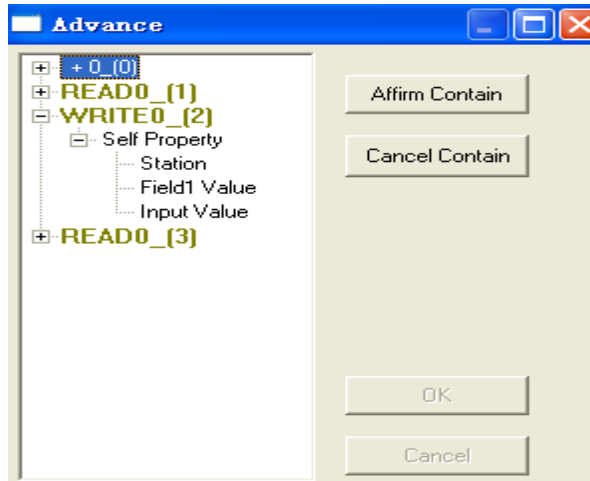

6. Click **Affirm Contain** button, complete “write” Component contain. Click the plus sign **+** in front of “write-contain unit”, then click the plus sign **+** in front of **+ 0 (0)**, open its self property, as follows:

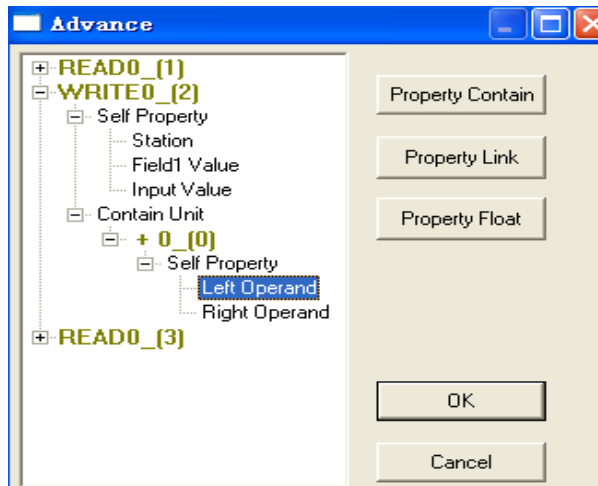

7. Select **Left Operand**, Click the right button **Property Contain** in the dialog box, the button will be grayed-out non-operational status, while text changed into “affirm contain”, as follows:

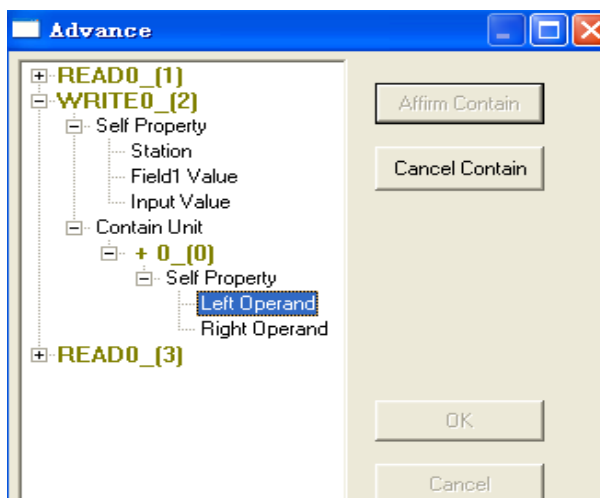

8. Select **READO_1**, button **Affirm Contain** immediately changed into operational status , as follows:

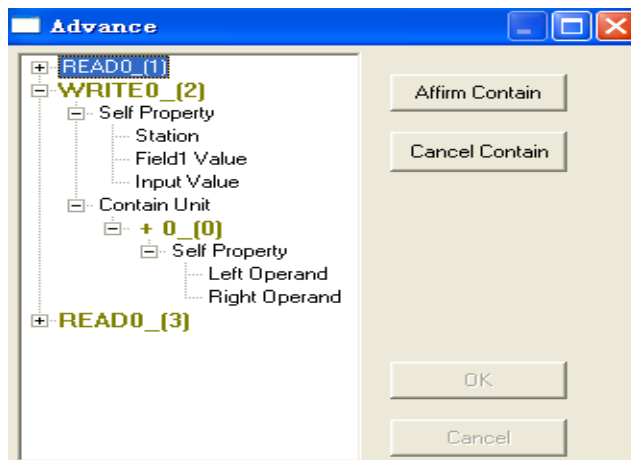

9. Click **Affirm Contain** button, complete **+ 0_0** left operand Component contain.

10. Select **Right Operand**, Click the right button **Property Contain** in the dialog box, the button will be grayed-out non-operational status, while text changed into “affirm contain” , as follows:

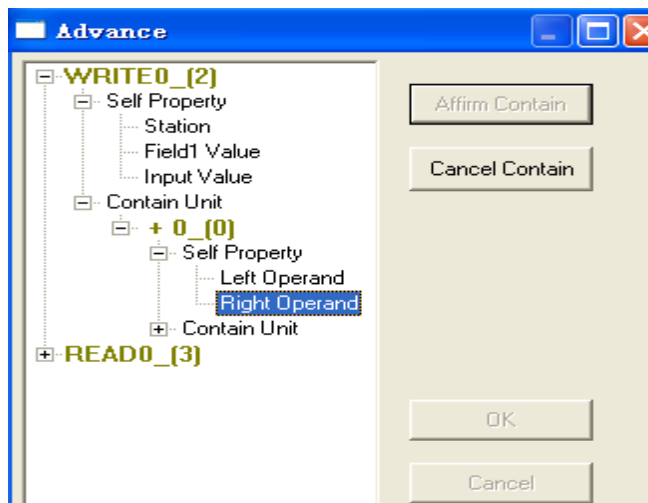

11. Select **READO_3**, button **Affirm Contain** immediately changed into operational status , as follows:

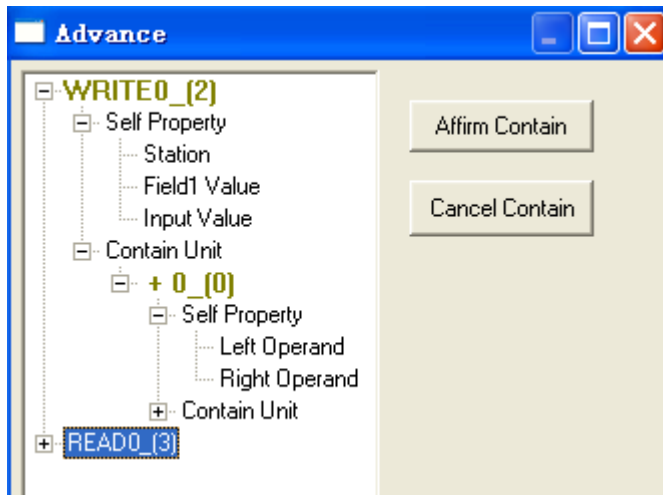

12 Click **Affirm Contain** button, complete **+ 0_0** right operand Component contain, The end results are as follows:

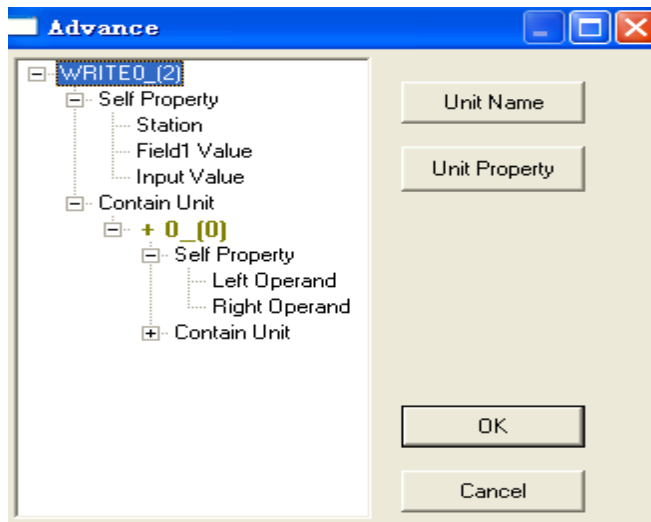

13. Click **Affirm Contain** button, complete advanced operation of arithmetic-plus. Click “offline simulation” icon, To see the results of the following operation:

$$\begin{array}{|c|} \hline \text{MI} \\ \hline 12 \\ \hline \end{array} + \begin{array}{|c|} \hline \text{MI} \\ \hline 23 \\ \hline \end{array} = \begin{array}{|c|} \hline \text{MI} \\ \hline 35 \\ \hline \end{array}$$

The above operation mainly introduce the operation of arithmetic-addition, the following will introduce multiplication

Step5: Arithmetic-multiplication Set

1. Select all the contents of the screen, as shown below:

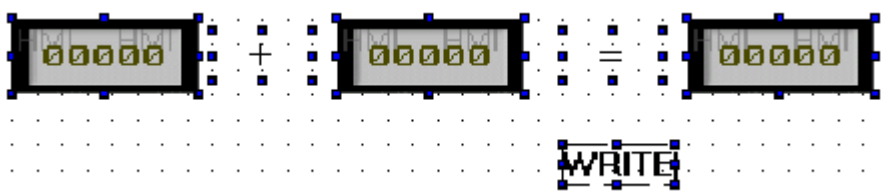

2. Right-click to choose copy, then in the blank area right-click to choose paste, the results are as follows:



3. Dragging replicated components to the suitable location, as follows:

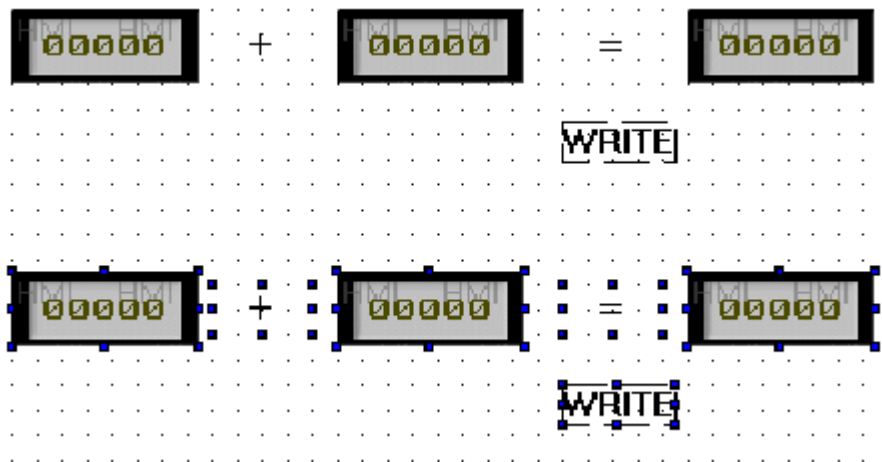

4. "Digital Input" Properties modifications:

In turn from left to right to open the "digital input" property, modify their objects, point separately to PSW303, PSW304, PSW305, as follows:

Object
 Object PSW 303
 Indirect

Object
 Object PSW 304
 Indirect

Object
 Object PSW 305
 Indirect

5. Select the bottom "write", Right-click, then in the pop-up list select advanced, as follows:

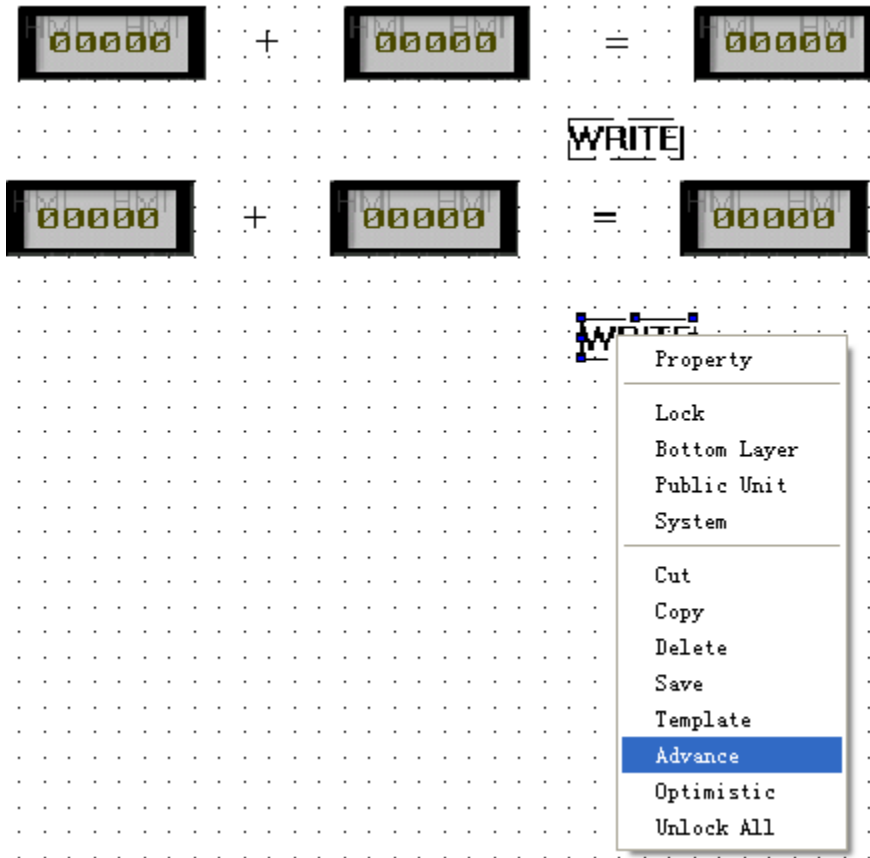

6. Open the advanced dialog box, as shown below:

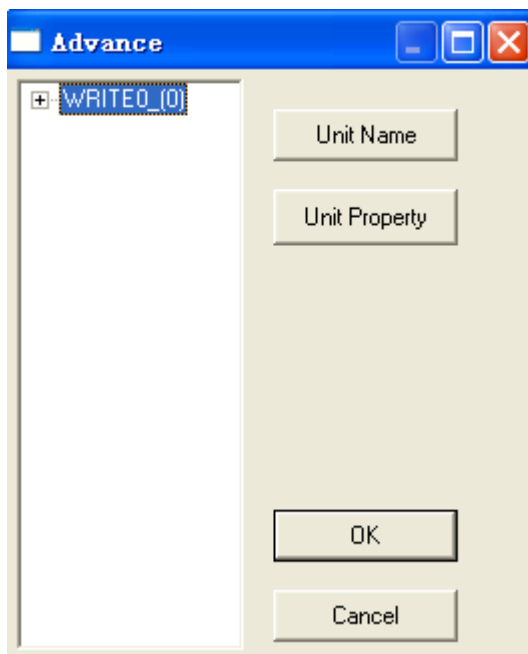

7. Select “write”, click the right **Unit Property** button in the dialog box, open the property box , here the modify type is register, object is PSW305:



8. Click the plus sign in front of “write”, then continue to click the plus sign in front of “write-contain unit”, selecting $\oplus + 0_{(1)}$, click the right **Unit Property** button in the dialog box, open arithmetic’s property box , Click the small arrow button on the right , In the

drop-down list , select , click “ok” to complete the properties setting of $\oplus + 0_{(1)}$,as follows:

9. Click the plus sign in front of “contain unit” of $\oplus + 0_{(1)}$, selecting $\oplus \text{READ0}_{(2)}$,click the right **Unit Property** button in the dialog box, open the property box , here the modify type is register, object is PSW303:

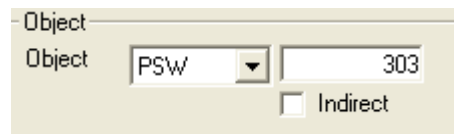

10. Click the plus sign in front of “contain unit” of $\oplus + 0_{(1)}$, selecting $\oplus \text{READ0}_{(3)}$,click the right **Unit Property** button in the dialog box, open the property box , here the modify type is register, object is PSW304:

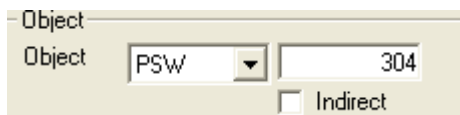

11. Finally click the “OK” button, complete the setting of multiplication.
 12. Now the operations of multiplication have been completed. Click “offline simulation” icon, to see the results of the following operations:

$$\begin{array}{c}
 \begin{array}{|c|c|} \hline \text{IMI} & \text{EMI} \\ \hline 10 & \\ \hline \end{array} + \begin{array}{|c|c|} \hline \text{IMI} & \text{EMI} \\ \hline 10 & \\ \hline \end{array} = \begin{array}{|c|c|} \hline \text{IMI} & \text{EMI} \\ \hline 20 & \\ \hline \end{array} \\
 \\
 \begin{array}{|c|c|} \hline \text{IMI} & \text{EMI} \\ \hline 10 & \\ \hline \end{array} * \begin{array}{|c|c|} \hline \text{IMI} & \text{EMI} \\ \hline 10 & \\ \hline \end{array} = \begin{array}{|c|c|} \hline \text{IMI} & \text{EMI} \\ \hline 100 & \\ \hline \end{array}
 \end{array}$$

4.2.8 NOP N

●**Overview:** "NOP" instruction is empty operation, that is, do not perform any operations, to maintain the existing operating state.

●**Routine:** The following will illustrate:

Step1: make "revert" indicator button, point to PSB300:

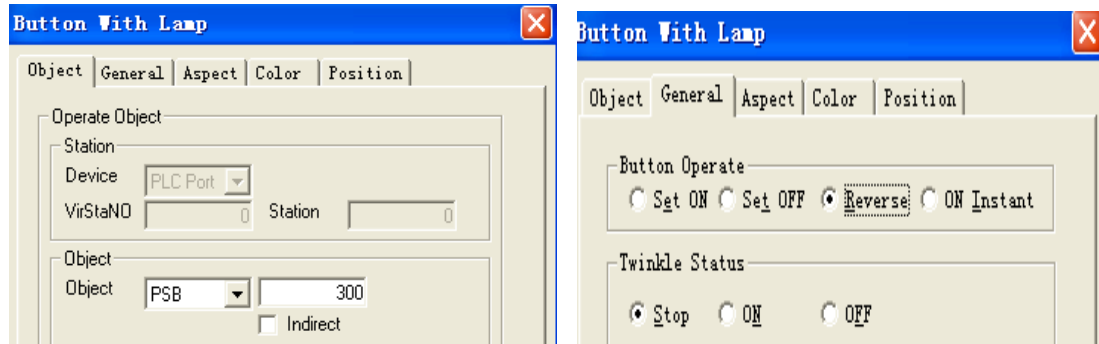

Step2: Placing "Read", "IF", "Nop" advanced parts and to display pictures on the screen. "read" unit's setting as follows:

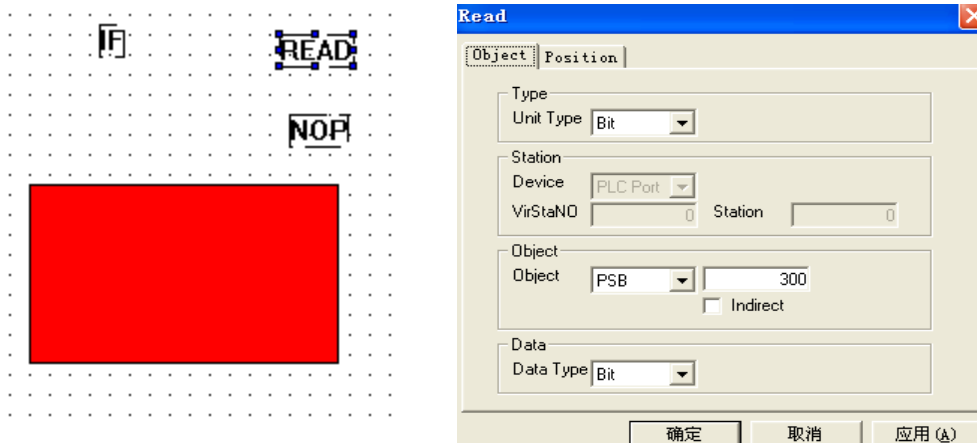

As the following steps, adding "Read" as "IF" component's contain unit:

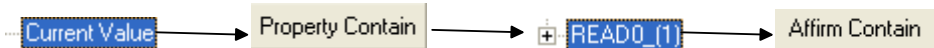

Respectively, add "NOP" element and "image" as self unit of "IF" component .specifically with reference to above-mentioned relevant parts, as the shown below:

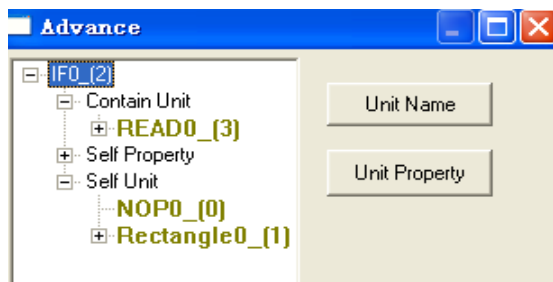

●Note the order of "Nop" element and "image"

Step3: Through "off-line simulation" to observe run effects,

Application case of empty operation



- The PSB300 for the ON state, will hidden pictures.

4.2.9 Converse NOT

● **Overview**

Negation operation is on the current operand bitwise operations to take converse operation, namely, the operation is from 1 to 0 or from 0 to 1, usually associated with "read" element to use.

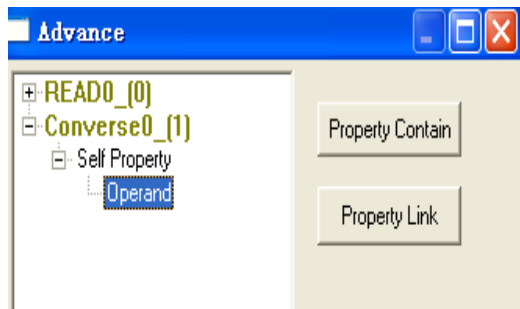

- open “advanced” property, via “operand” to “property contain” target object

● **Routine**

The following will illustrate the use of “reverse” button:

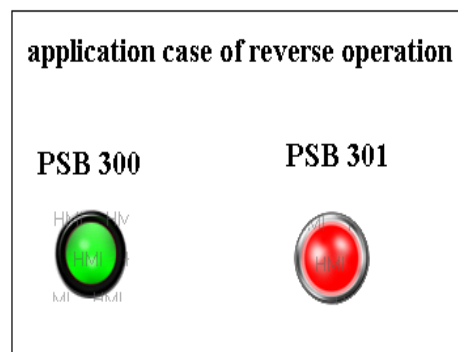
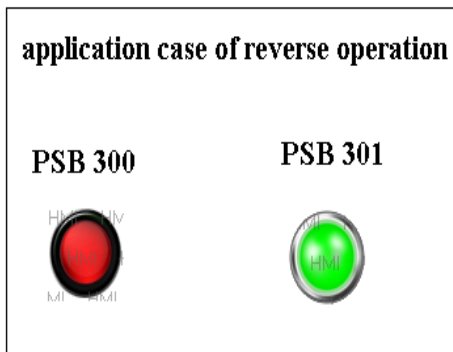

In the case, PSB301 and PSB300 have the opposite state

Implementation steps:

Step1: make “PSB300 indicator button” and “PSB301 lamp” parts.

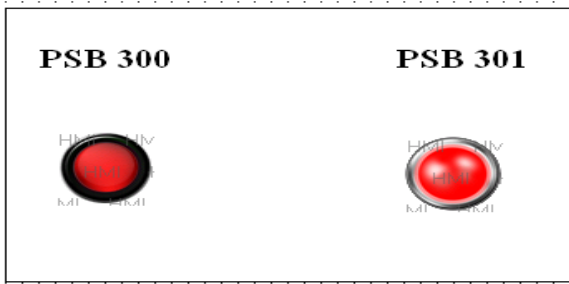

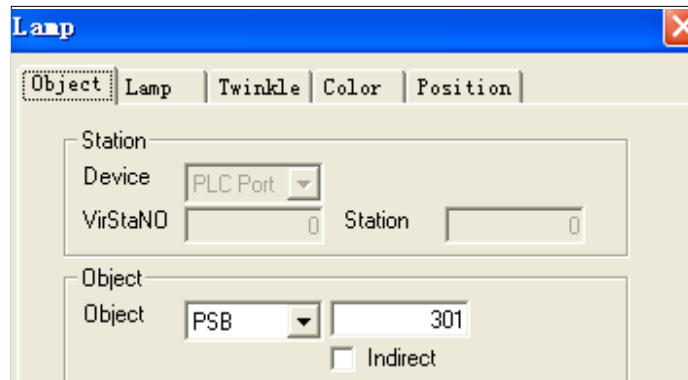
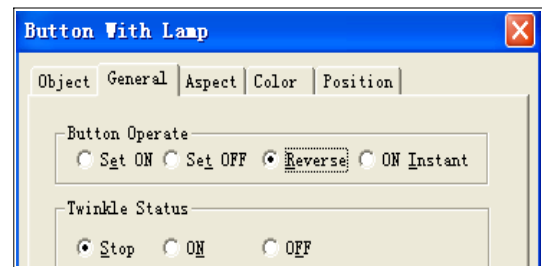
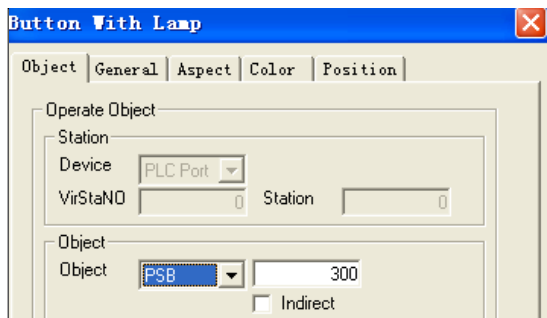

- To indicator button ,object point to PSB 300, button operate choosed as “reverse” .
- Lamp object pointed to PSB301

The properties modification as follows:



Step2: Advanced operations

Putting one  , one  and one  on the screen, as follows:

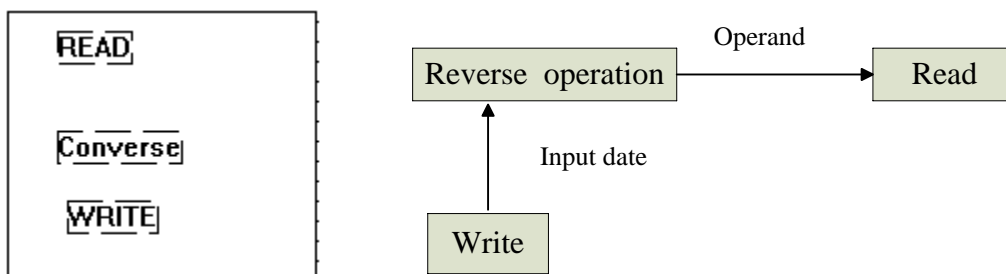

According to the following order, adding “read” component as “converse” component’s “contain unit”.

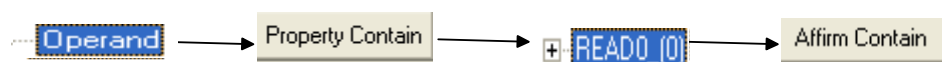

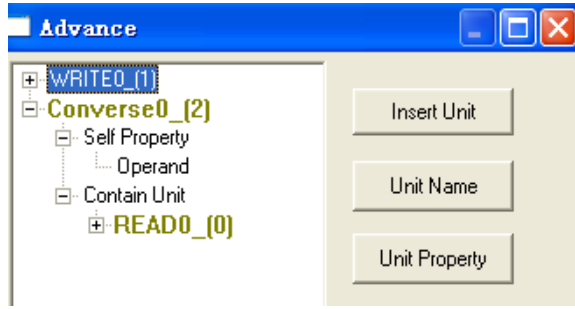

According to the following order, adding “converse” component as “write” component’s “contain unit”.

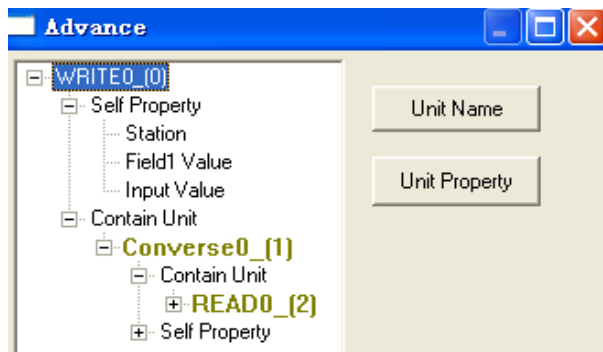
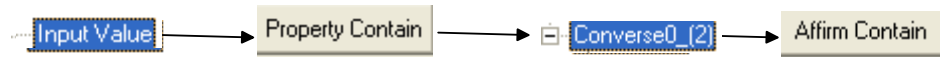

Step3: Modify “read” unit and “write” unit’s property, point separately to PSB300 and PSB301, as follows:

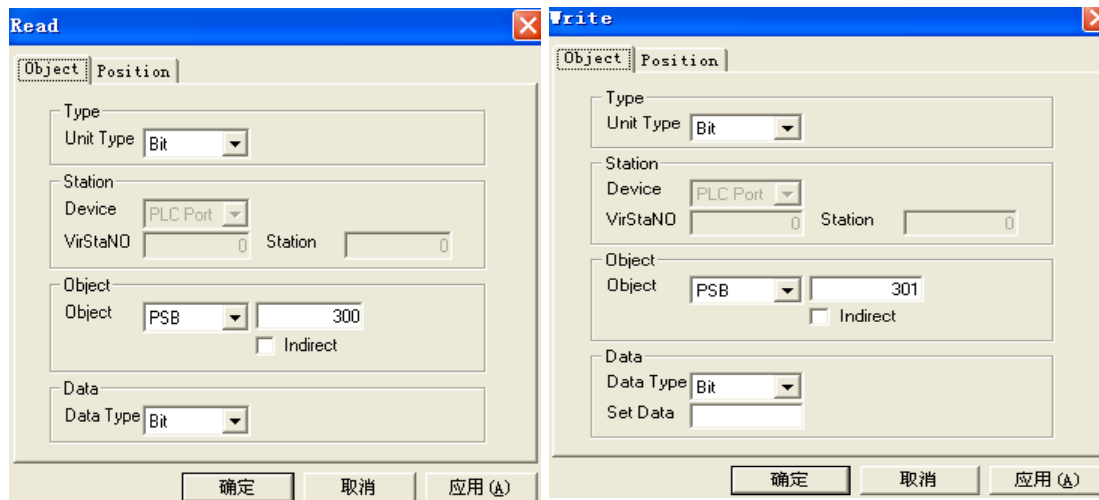

Step4: Trough “offline simulation” to observe the effects, Can be observed PSB301 and PSB300 have the opposite state

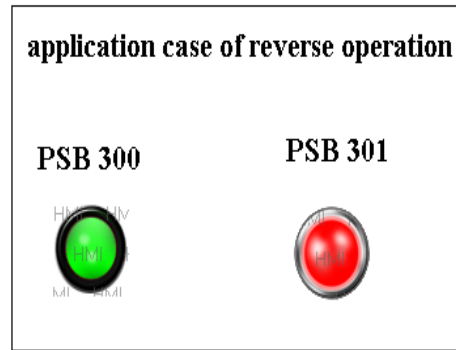
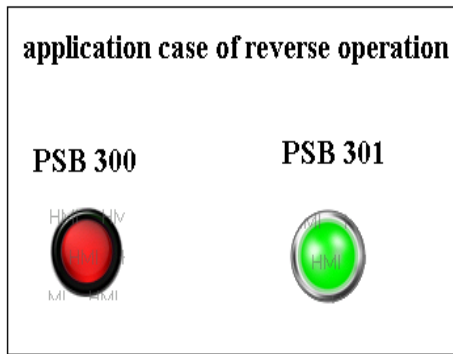

In the case, PSB301 and PSB300 have the opposite state

4.2.10 “And, Or, Not”

• Overview

"And, Or, Not" component to achieve the function of logical operation, also known as “logical operation” component, that is, And, Or, Not operation.

Description: Participate in operation can be a value or a bit, When the value is non-0 or bit in the ON state, the number (or bit) is identified as "true" (Binary number

“1”). When the value is 0 or bit in the OFF state, the number (or bit) is identified as a “false” (Binary number “0”), Then use the two binary number to carry out And, Or, Not logical

operation, then got the outcome , Algorithm is as follows:

1 and 1=1, 1 and 0=0, 0 and 0=0;

1 or 1=1, 1 or 0=1, 0 or 0=0;

1 not= 0, 0 not=1.

Its advanced properties of the following diagram(Right-click , in the pop-up list select “advance”):

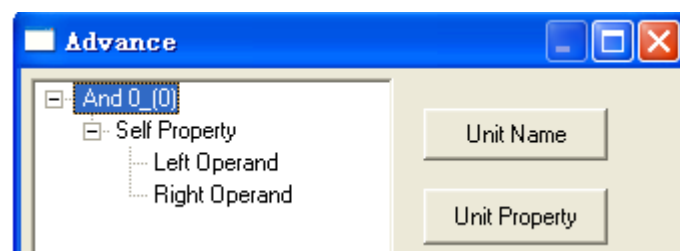
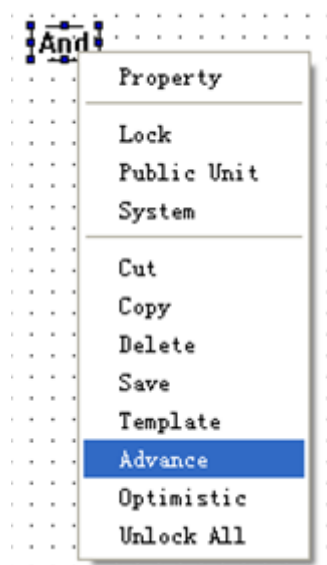

- Left Operand/Right operand: Select the two operation required data

Unit Property:

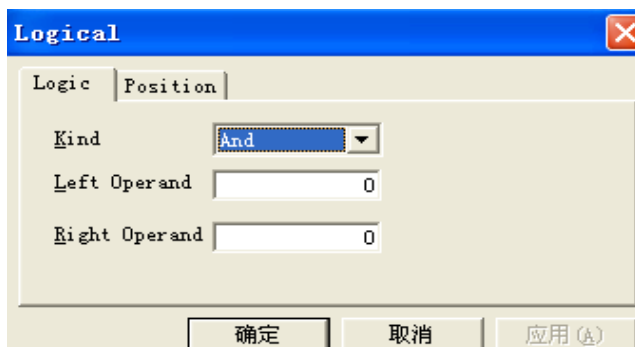



- Kind: Manually specify the operation kind,
- Left Operand/Right operand: Manually specify the operation required two data

Example:

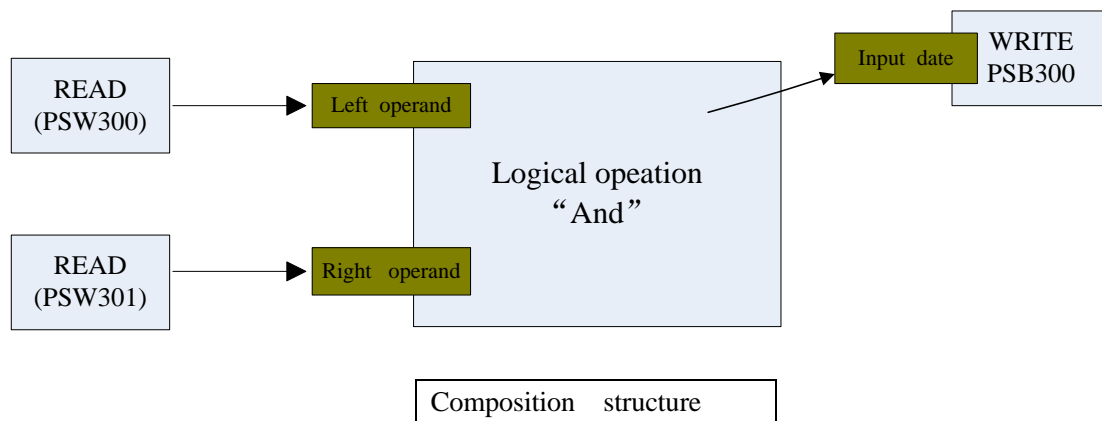
Use PSW300 and PSW301 as the two operands to carry out logic “And” operation, the results output to PSB300.



① Place a "logical" , two "read"  one "write" , as follows:

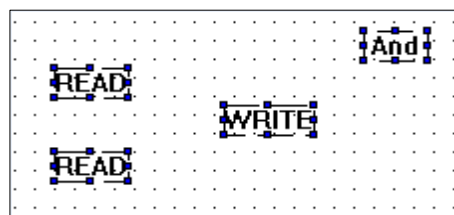

Settings are as follows: select “logical kind” as “And”, modify the two “read” unit’s property. point separately to PSW300 and PSW301. “Write” is PSB300.

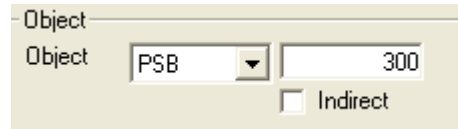
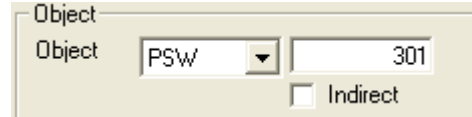
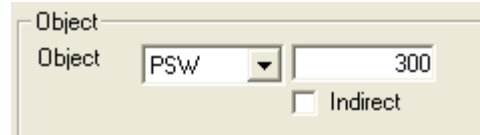
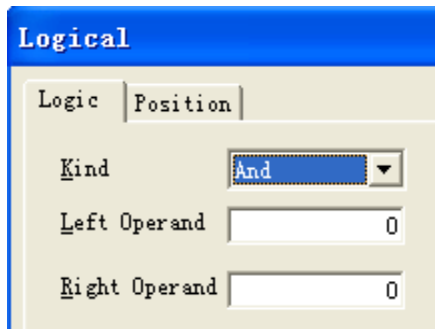

② Box above components, right-click, in the pop-up list select “advance”, as follows:

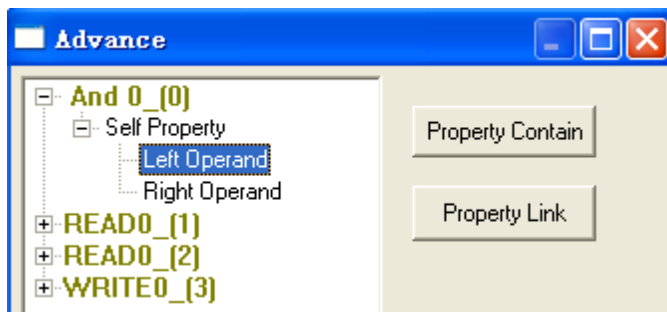

“Left operand” property contains one “read” unit.

“Right operand” property contains the other “read” unit.

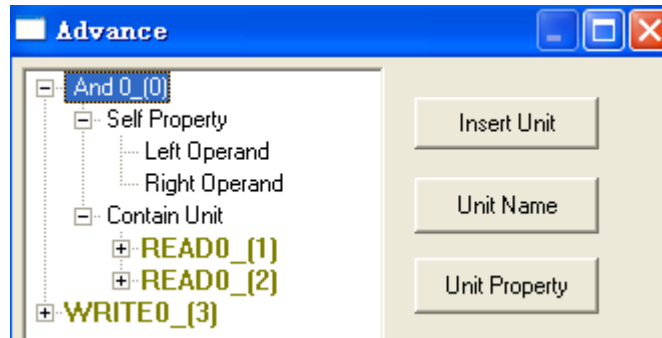

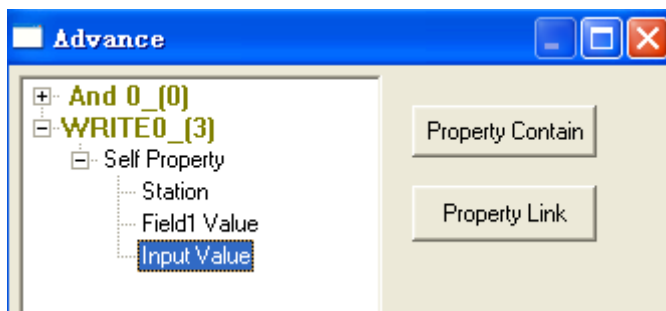

“Input value” property contain “And 0_ (0)”

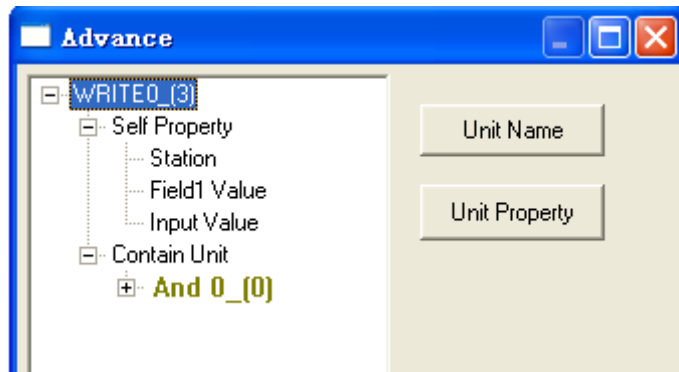



Click “Ok” to complete the operations.

- ③ Placing two “digital input” unit , one “lamp” , three “text” on the screen. modify the two “digital input” unit’s property. point separately to PSW300 and PSW301. “Lamp” is PSB300.as follows:

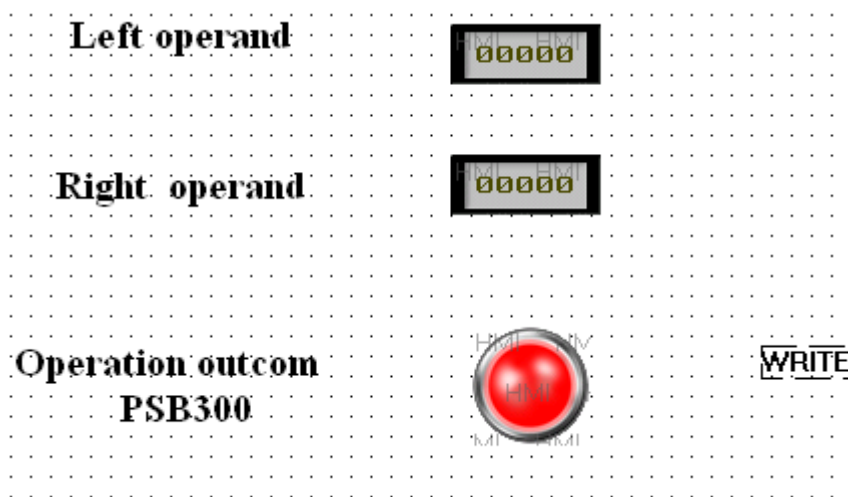

- ④ Trough “offline simulation” to observe the effects, as follows:

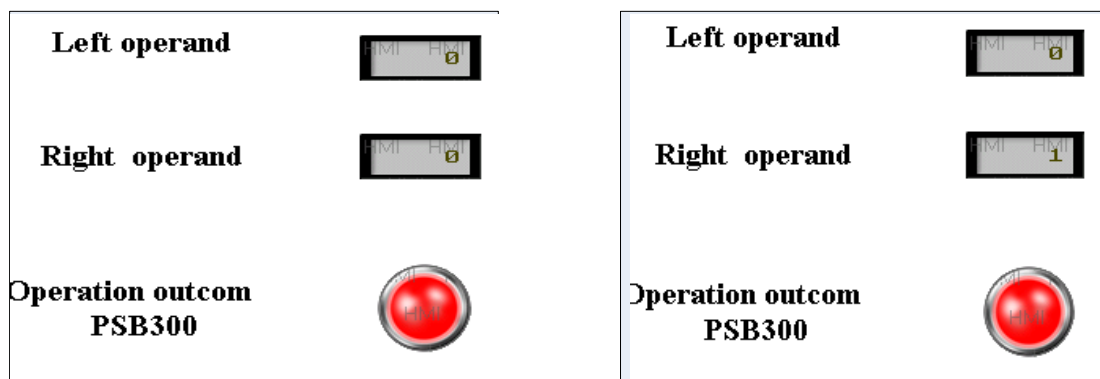

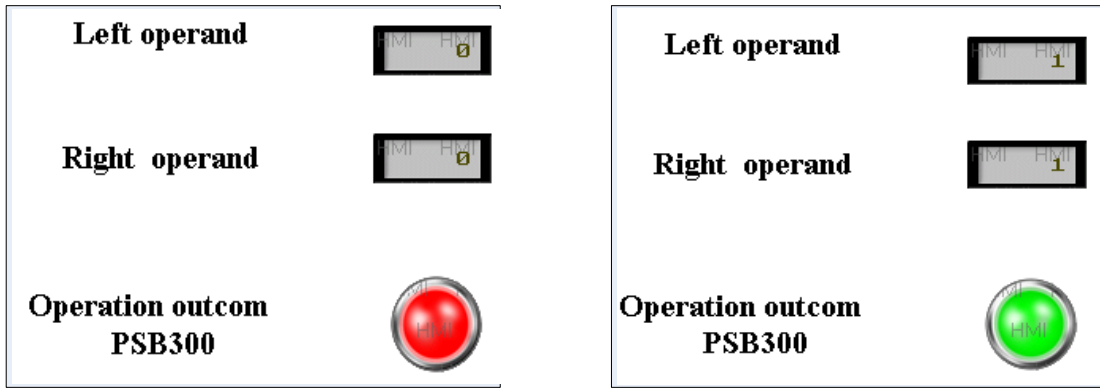

Only when the PSW300 and PSW301 are non-0 value, PSB300 will be in ON state, otherwise PSB300 is OFF.

4.2.11 “Compare”

• Overview

“Compare” component used to achieve the function of data compare, also can be called “ data compare”. When the comparison result is true (compare relationship was established), the device will turn-on (turn to ON state), so it can also be used as other component’s data source.

Its advanced properties of the following diagram(Right-click  , in the pop-up list select “advance”):

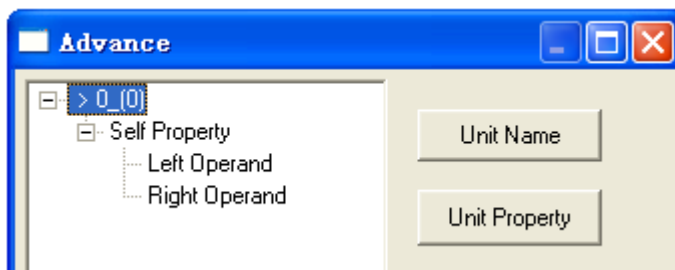



- Left Operand/Right operand: the two operation required data
- Compare kind: Manually specify the operation kind,
- Data format: Comparative data is based on which system
- Left Operand/Right operand: Manually set the operation required two data

Example:

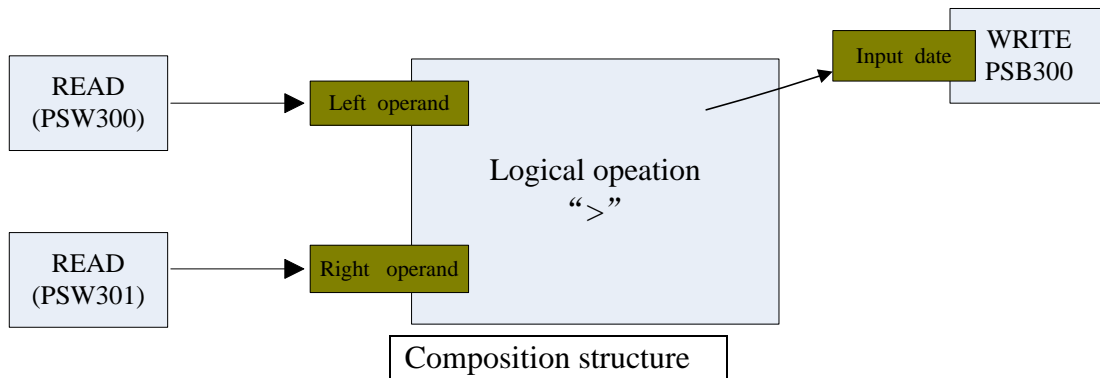
Use PSW300 and PSW301 as the two operands to complete data comparison, when PSW300>PSW301, set PSB300



① Put one "Date compare" , two "read" , one "write"  on the screen. as follows:

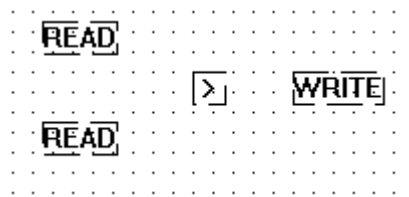

Settings are as follows: modify the two "read" unit's property. point separately to PSW300 and PSW301. "Write" is PSB300. "Data compare" comparison type choose ">" 

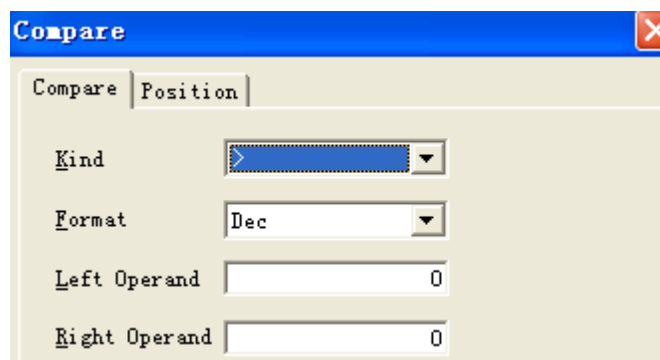

② Box above components, right-click, in the pop-up list select "advance", as follows:

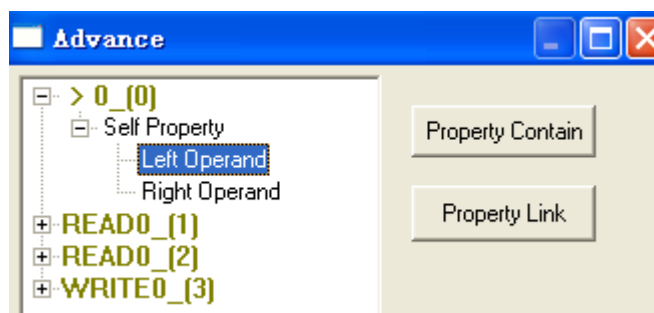

"Left operand" property contain PSW300 "read" unit.
 "Right operand" property contains PSW301 "read" unit.

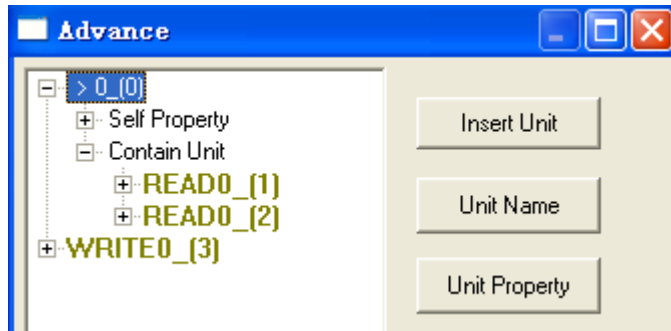

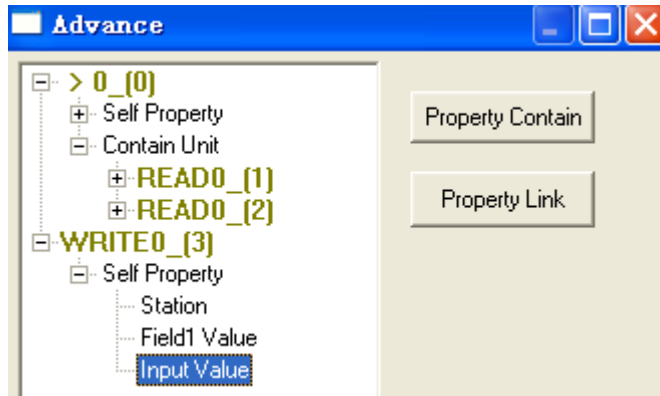

Write component's "Input value" property contain  > 0_[0]

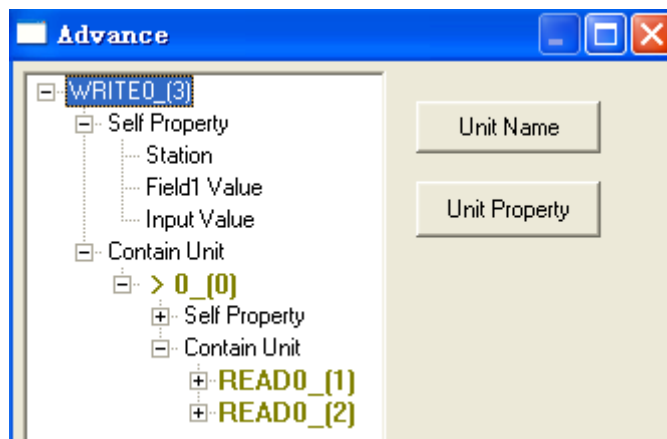

The final as follows:



- ③ Placing two “digital input” unit , one “lamp” , three “text” on the screen. Modify the two “digital input” unit’s property. point separately to PSW300 and PSW301. “Lamp” is PSB300. After the completion of the following diagram:

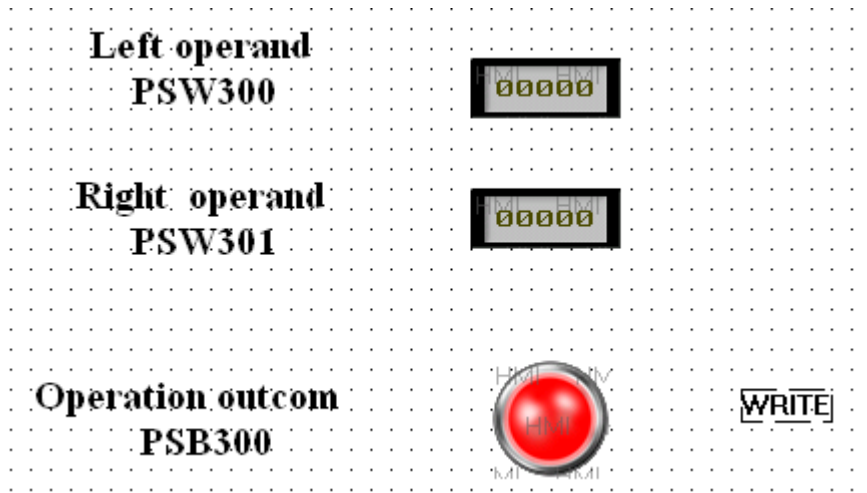

④Trough “offline simulation” to observe the effects, as follows:

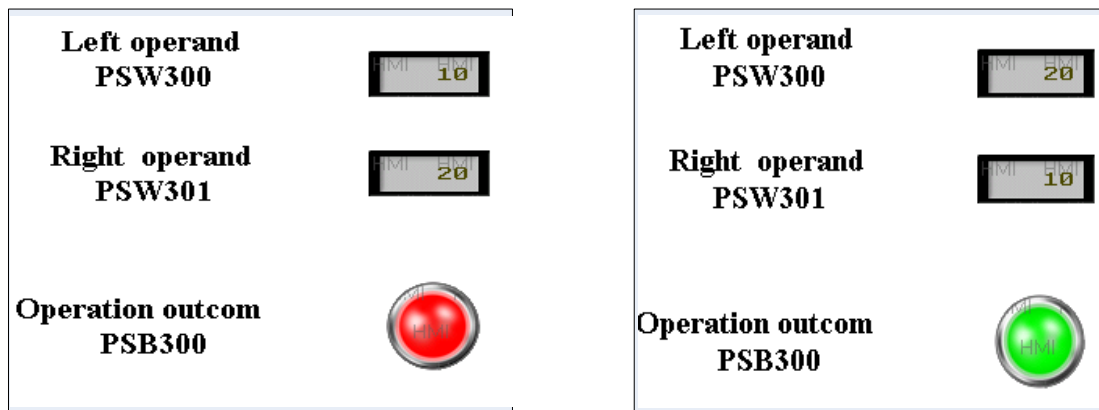



When the date of PSW300 is larger than the date of PSW301 , PSB300 will be in ON state

4.2.12 Edge

Overview: And the "Read" or other components used with together, take the number of rising or falling edge operation.

Example: Set M10 When the falling edge of coil M0

Step1: Place a “read”  ,one “write”  , one edge  on the screen, as follows:

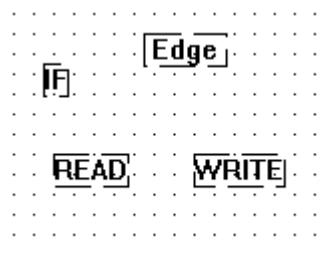

Step2: Double-click “Read” component  , object point to M0

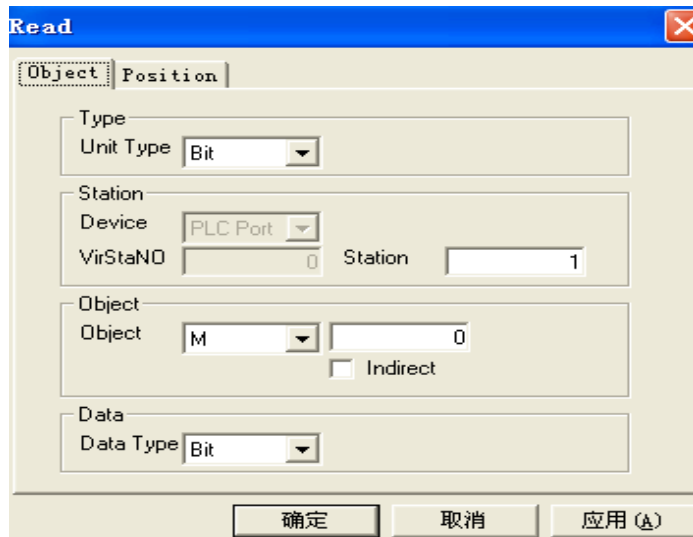

Step3: Double-click “Write” component  , object pointed to M10,set data as 1.

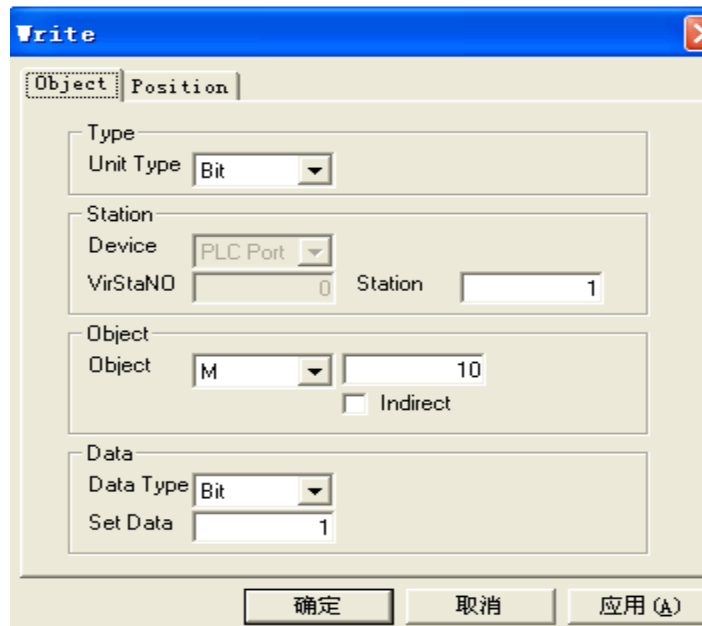

Step4: Double-click “Edge” component  , pop-up the following box, select “type” as “Descend”.

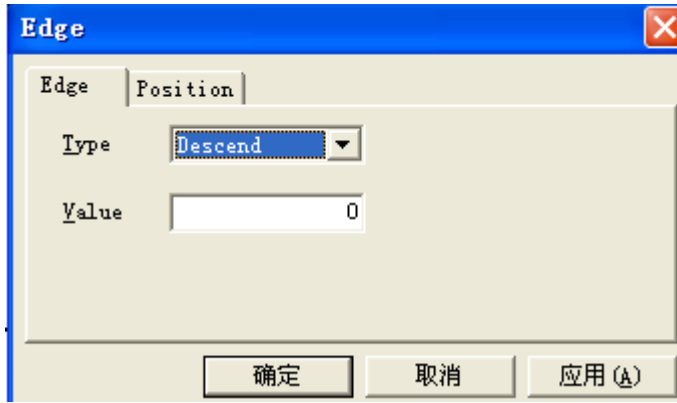

Step5: "Operand" of Edge property contain "read"

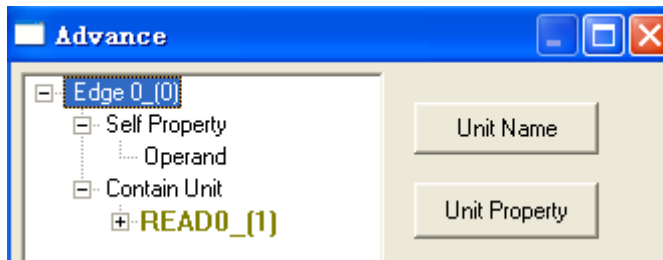

Step6: "IF" component's "current value" property contain Edge unit.

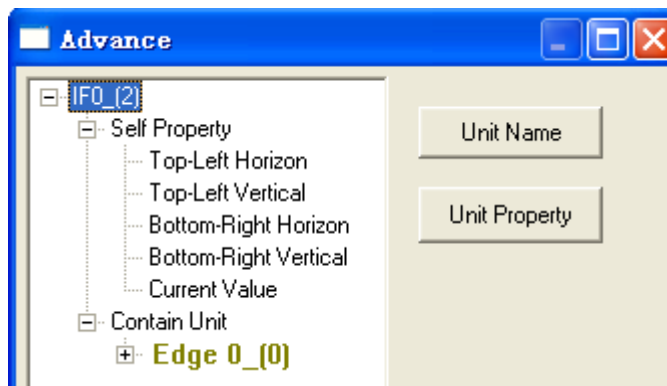

Step7: WRITE component insert into IF component

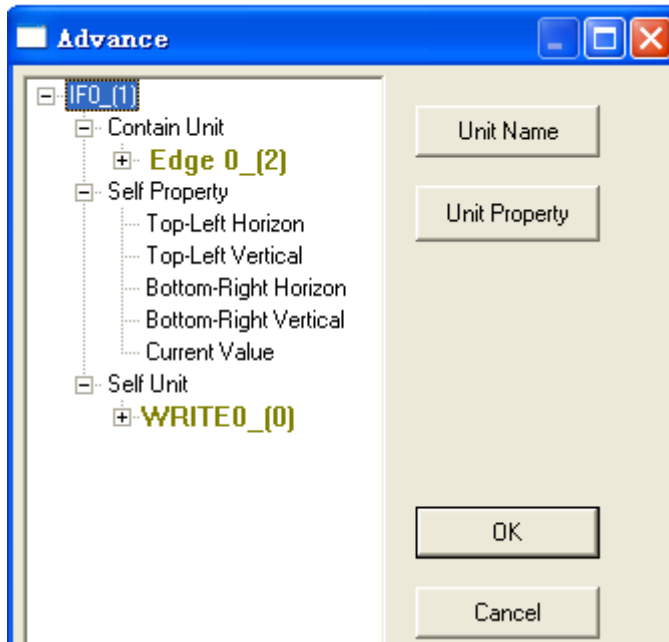

Step 8: place one indicator button and a lamp on the screen , modify the property of the two parts, To indicator button, point object to M0, select “button operate” as “On instant”, To lamp, point object to M10. As follows:



Step9: Please download the project to the touch screen, run in the touch screen, observing the effect of operations. Click the indicator button, when indicator button in the releasing state, the lamp will be light.

4.2.13 Window

- **Overview**

In practice application, Window components are very widely used, such as pop-up reminder, alarm information, password screen, etc. Users typically use call window, window button, function button or functional field of software base components to achieve, but it is not flexible, so we can use touch screen advanced command to realize, this section will introduce the advanced part window.

Property Description:

(1)Place component

Open the touch screen software, create a new project, place one window element  on the

screen .as Follows:

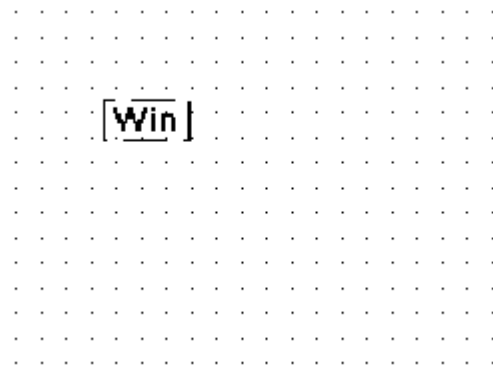

(2)General Property Description:

1.Double-click the Win components to open the Property window , as follows:

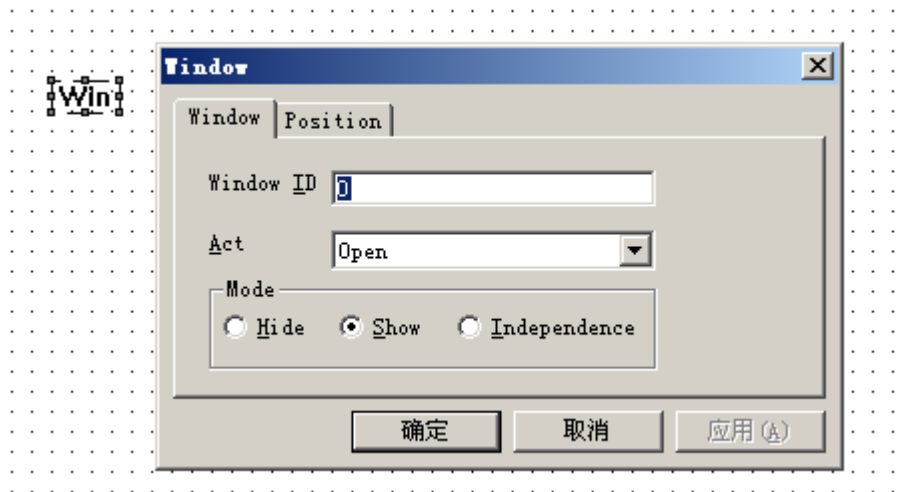

Property Name	Description
Window ID	The window to perform operations serial number, users can enter the Window number based on needed
Action type	the specified action to the specified window ,The default action type is window open , Click the small arrow button on the right side , in the drop-down dialog box can be seen three action types: window open, window closed, window state

Mode	Display Mode: hide, show, Independent <input checked="" type="radio"/> Hide Although the window is opened, but it is not visible; <input checked="" type="radio"/> Show The window is opened, and can be seen; <input checked="" type="radio"/> Independence Window is opened, but can be seen as an independent form. Note: Only action type is set as open, display mode in order to be actionable.
------	---



Property Name	Description
Position	It is a coordinate point, that is, upper left corner of the window location, position: X and Y <input checked="" type="checkbox"/> X :X point <input checked="" type="checkbox"/> Y :Y point
Lock	Used to Fixed window position , avoid component being easily moved during operation . Select the locked position, or do not lock.
Visible	Whether the window component Placed on the screen is visible, select the component visible or not visible.

(3) advanced property

Right click win component, in the pop-up dialog box, select advanced, as the left diagram, the advanced property dialog box shown as the right diagram.

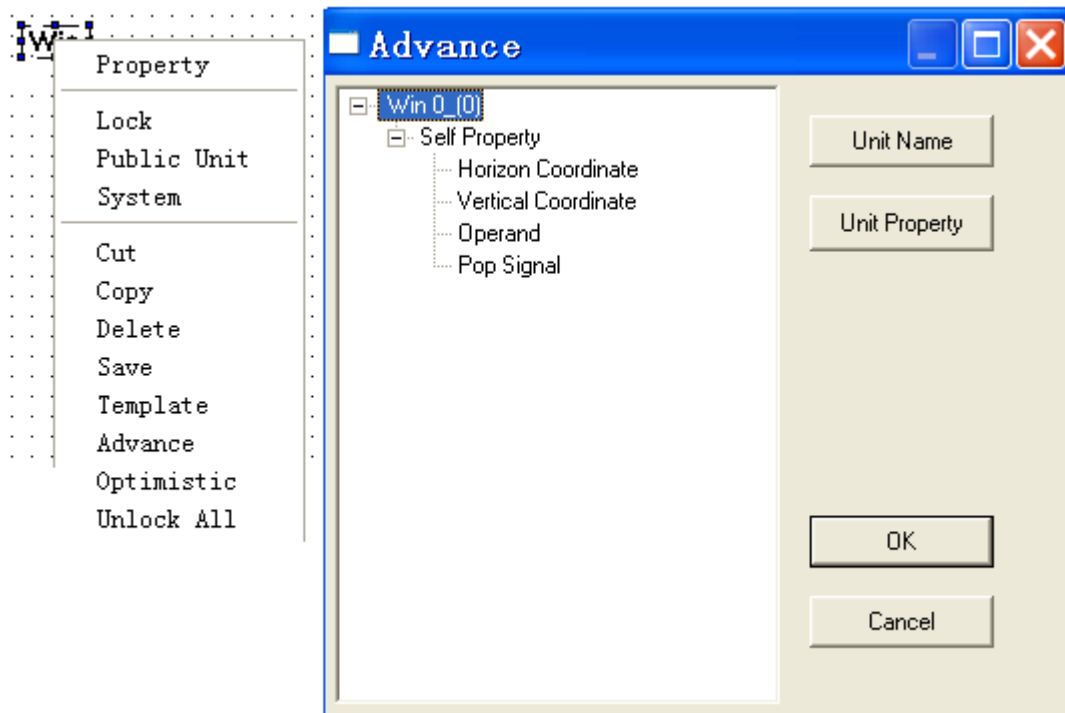

● **Routine**

Win component usually used with key, nop, if, switch and read components. Using win open or win closed, in this example, through the combination of key, nop, win components to achieve win open and win closed

Step1: Create a project, place parts on the screen

Create a new project, put two rectangle parts  on the screen, the color of rectangle 1 is red, size is 50*30, the color of rectangle 2 is green, size is 50*30, as follows:



Step2: Put advanced parts: one key , one nop , one win , as follows:

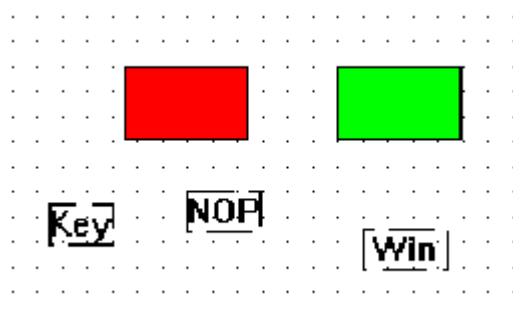

1. Double-click key component, open the Property dialog box, set **Width** as 50. Set **Height** as 30, as follows:

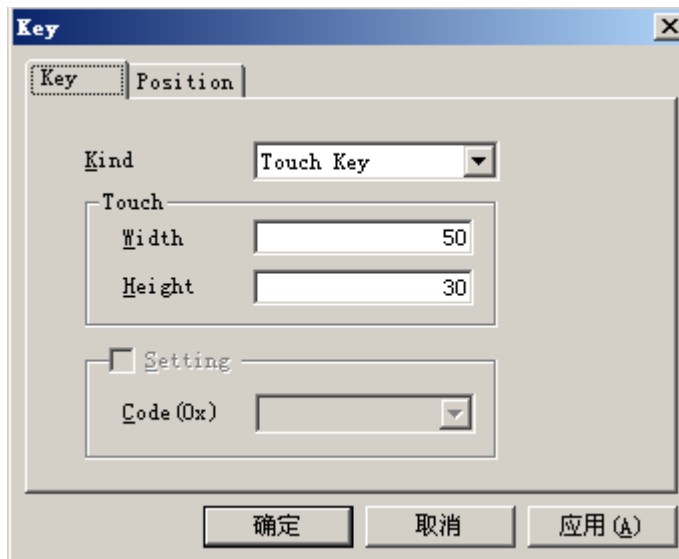



2.2. Double-click win component, in the window option, set

Window ID as 1, set **Act** as **Open**, set **Mode** as **Show**, in the position option, set **X** as **200**, set **Y** as **200**, as follows:

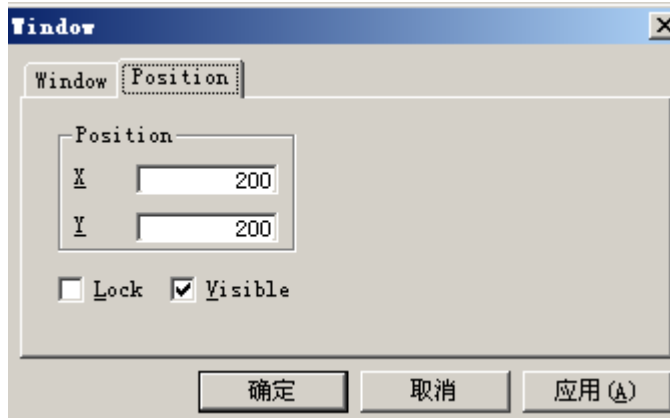



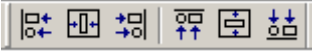

Step3: advanced operations-open window

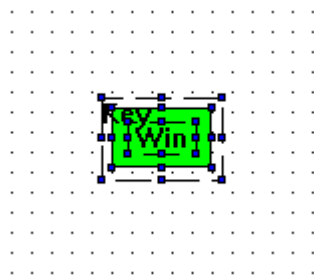
1. Select all the components, in the toolbar , click align center  and align middle , the final effects are shown below :

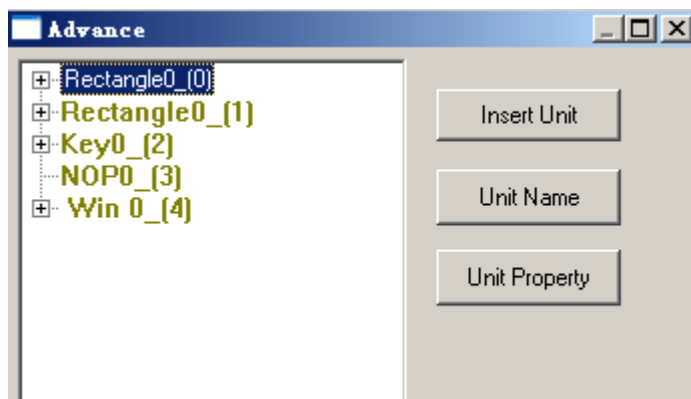

2. Right-click the select area , in the pop-up menu, select advanced, the advanced dialog box shown below:

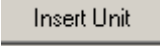

2. Select  Rectangle0_0, Click the right button  in the dialog box, the button will be grayed-out non-operational status, while text changed into “affirm insert” , as follows:

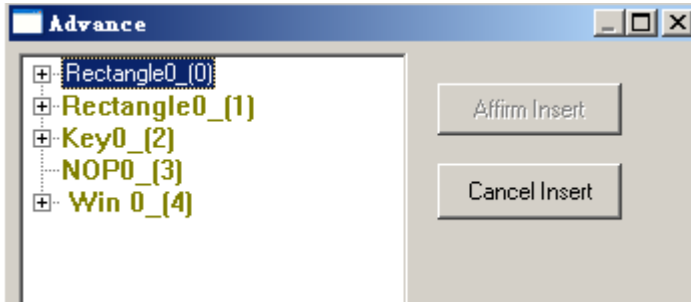

3. Select **Key0_2**, button **Affirm Insert** immediately changed into operational status, as follows:

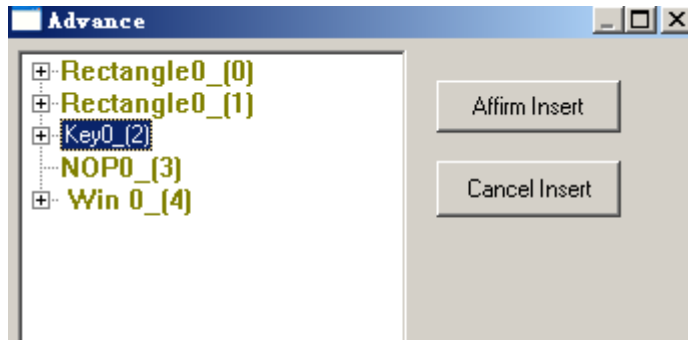

4. Click **Affirm Insert** button, complete the insertion, With the same operations, complete the insertion of **Rectangle0_1**, **NOP0_3**, and **Win 0_4**, The final screen as shown below:

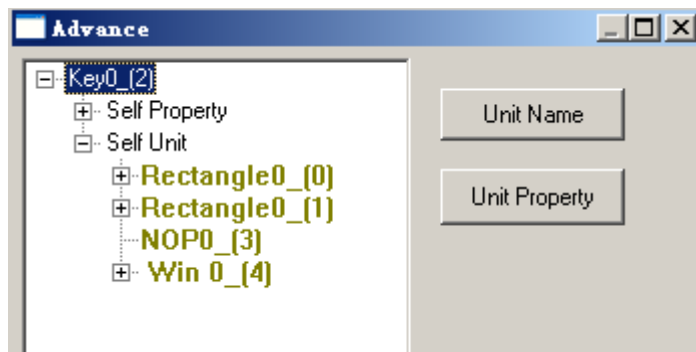

5. Finally click "OK" button to complete the advanced operations, the final screen as shown below:

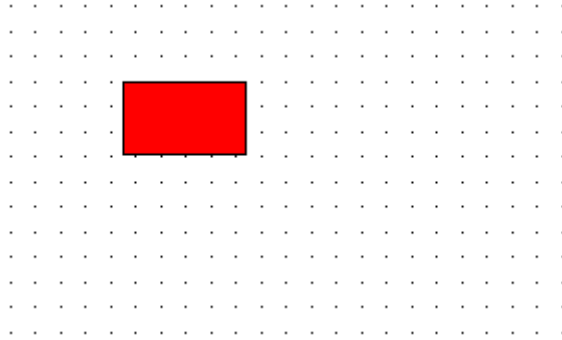

Step4: advanced operations-close window

1. Copy the part which made in the step 3, then paste one time , as follows :

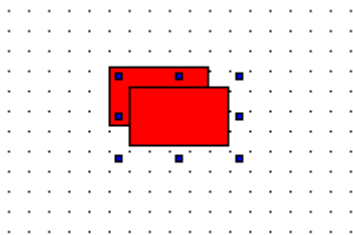

2. Right-click the paste part , in the popup menu selecting “advanced” , then will pop-up the following dialog box , as follows :

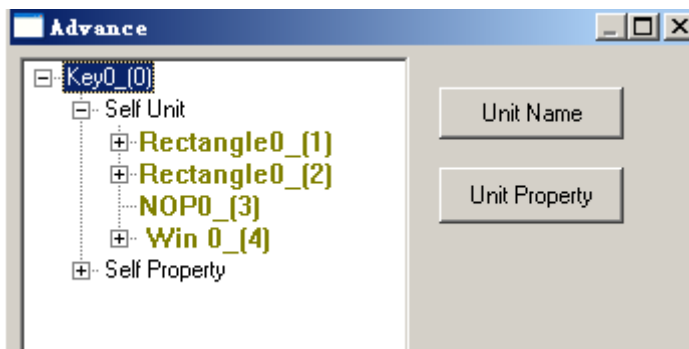

3. Select **Win 0 [4]** , click the right button  , pop-up the following dialog box, as follows :

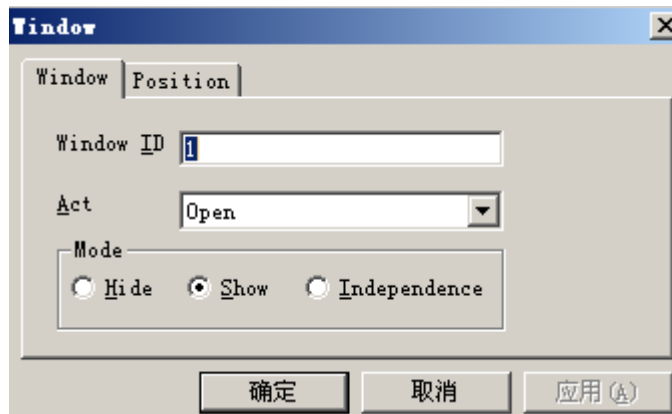

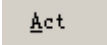
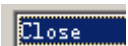
4. Modify  as  , Other parameters remain the default , then click “OK”

button . drag the close window Button to the appropriate location, as follows:

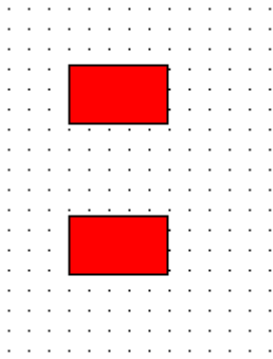

Step5: Create a window in the engineering column.

1. Open the software engineering field below the window list, and then right-click the window, as follows:

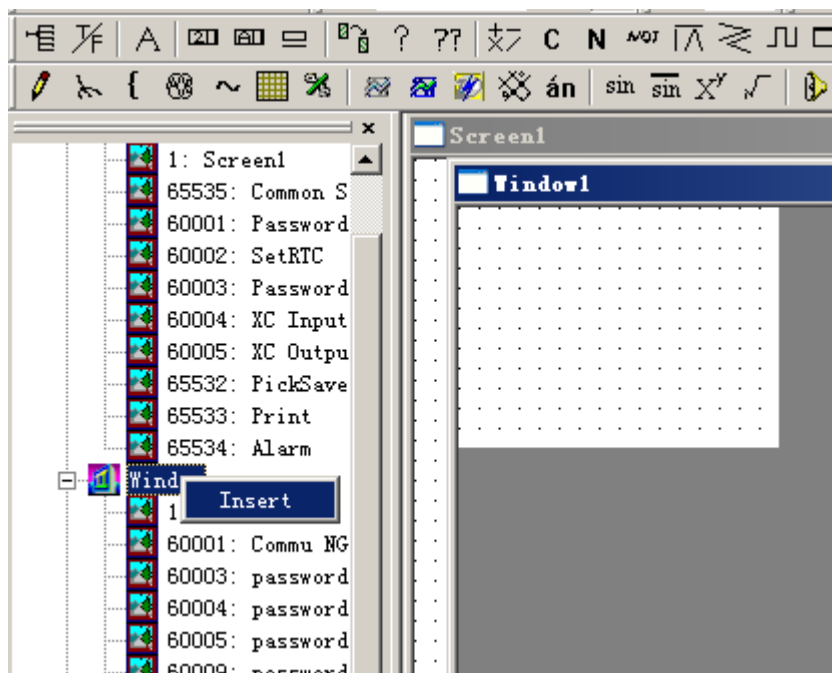

2. Click “insert” button, pop-up the following dialog box:

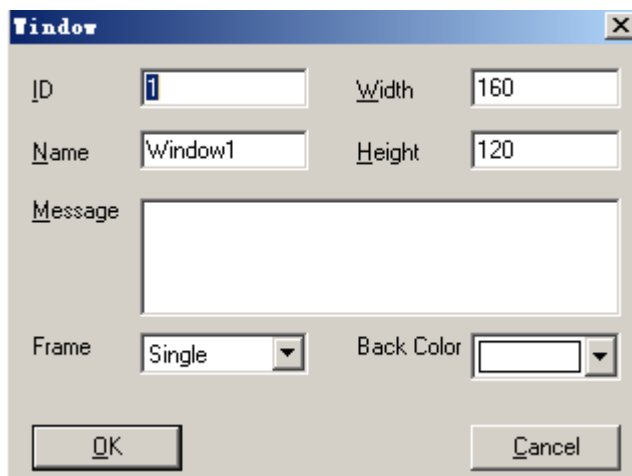

3.click “Ok” button , The window screen has been established , as follows :

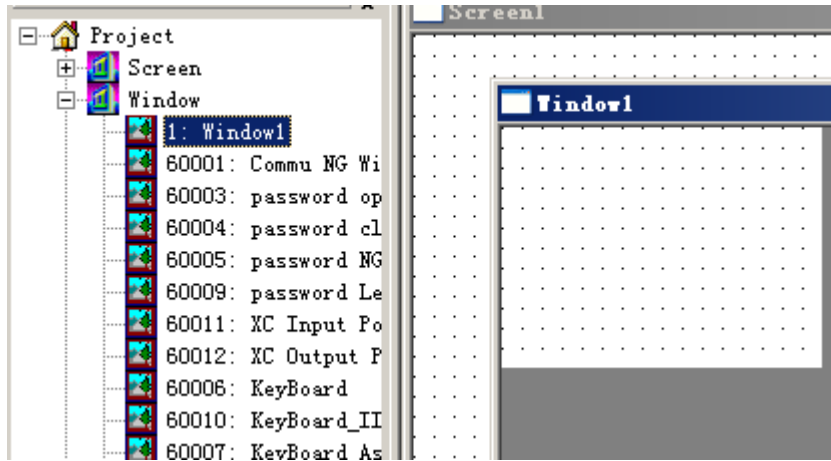

4. In the window 1 , put one “window button”  , as follows:

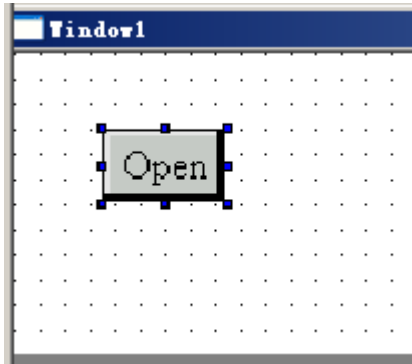

5. Double-click it to open the property dialog box , as shown below :

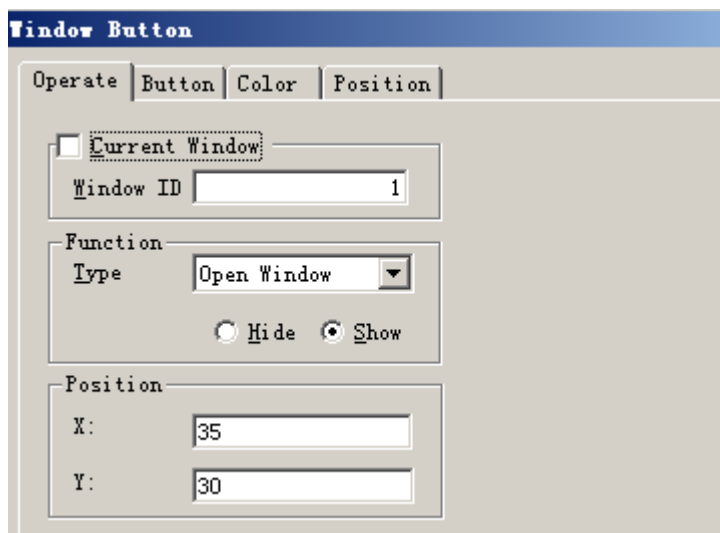

6. Set **Window ID** as 1, select **Function Type** as 

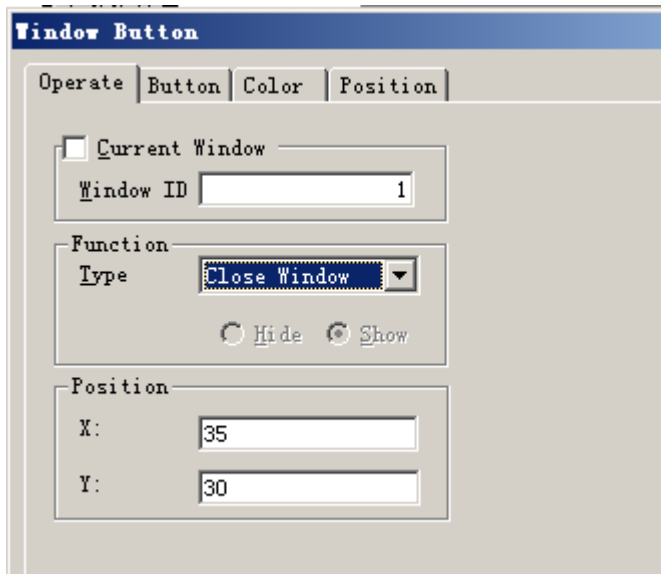

7. Select **Button** option, In the text editing area, enter the following text:

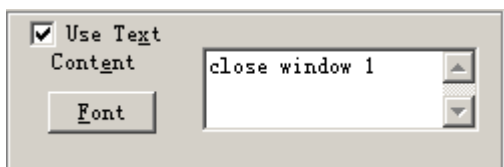

8. Select **Position** option, set **Width** as 100, set **Height** as 30, as shown below:

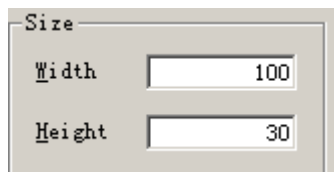

9. Click "OK" button to finish the setting.

10. Trough "offline simulation" to observe the effects

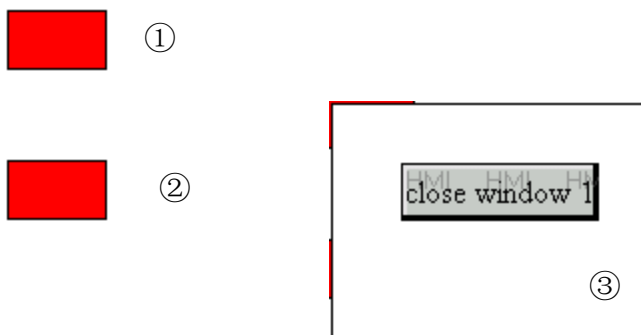

Note: click ① to open window, click ②③ to close window

4.2.14 Date D

- **Overview**

Match with Write and other components, as the assignment of a data carrier

- **Routine:** When set on the coil M0 , the value 100 is assigned to D0

Step1: Put one “IF”、 one “Read”、 one “write” and one “Data” on the screen, as follows:

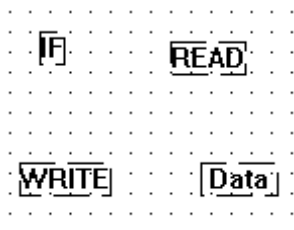

Step2: Double-click D component, open the Properties dialog box, set data value as 100. as follows:



Step3: Double-click “write” component, here the modify type is register. Object is D0. As shown below:

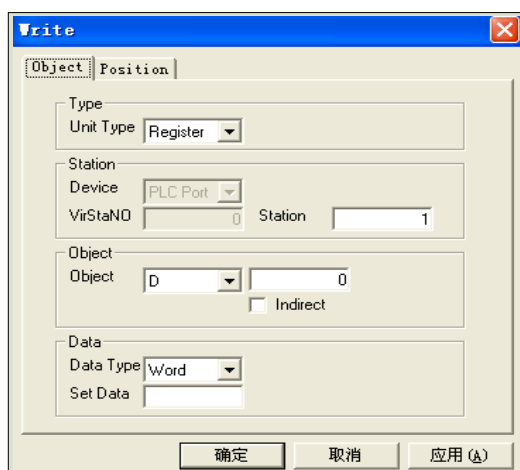

Step4: “Input value” of “write” property contain “Data”

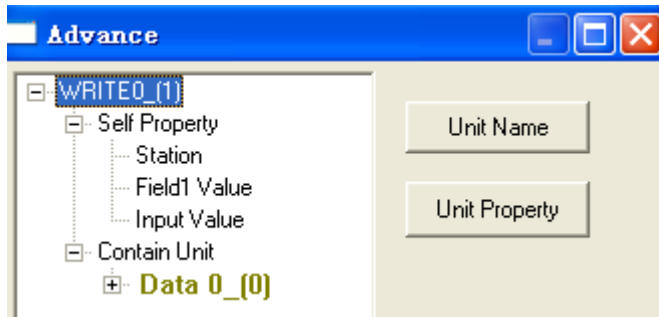

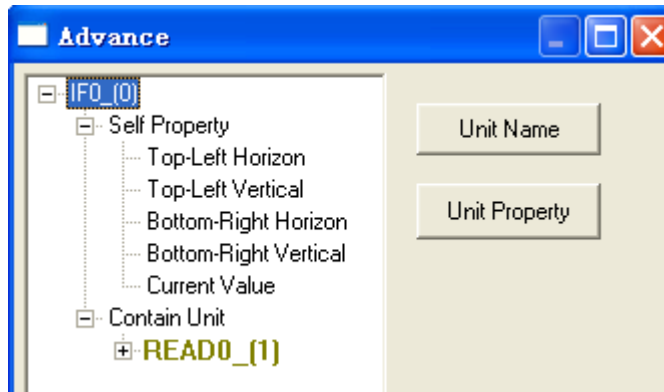

Step5: If component's "current value" property contain "read" component

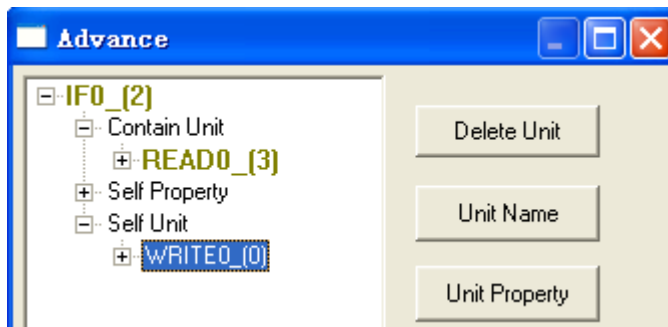

Step6: Insert "Write" component into "IF"



Step7: placing one "indicator button"  and one "Digital display"  on the screen, modify the property of the two parts, To indicator button, point object to M0, select "button operate" as "On instant", To "Digital display", point object to D0. as follows:

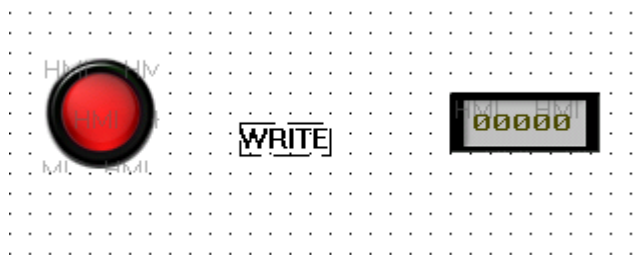



Step8: When press on the indicator button, the Digital display will display 100.

4.2.15 Conversion

Overview: Performing operations with Write and Read components. Can convert the data format and size

Example 1: Convert the float data of D0,D1 into a decimal data and stored in D2,D3

Step1: Placing one “read” , one “write”  and one “convert”  components on the screen, as follows:

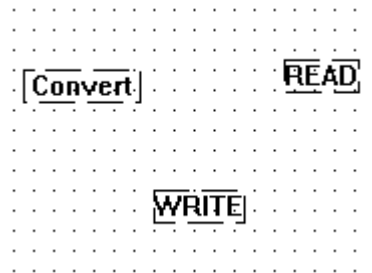

Step2: Double click “conversion” part, in the pop-up list, set source format as “Float”, set result format as “Dec”, ensure the upper and lower limit of data source and result keeping the same.



Step3: Double-click the “Read” component, here the modify type is register, object is D0 and data type is DWORD.

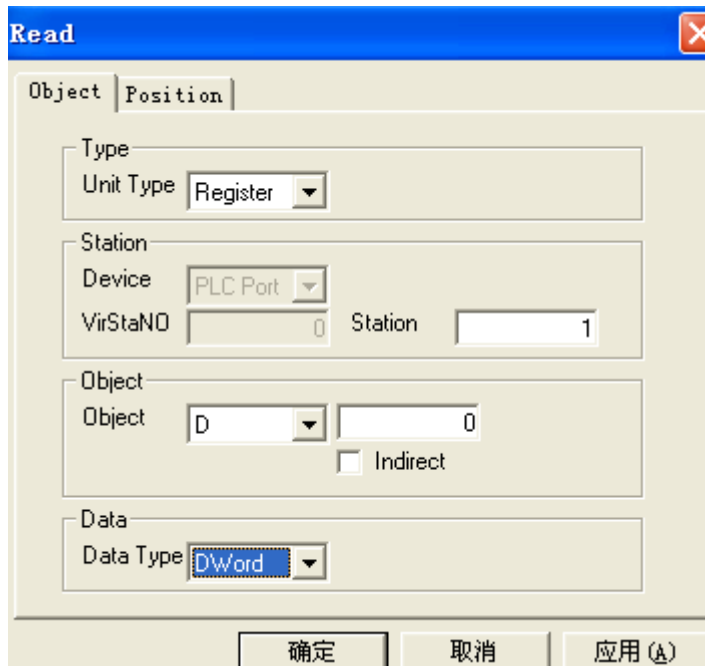

Step4: “source value” of convert property contain “read” component.

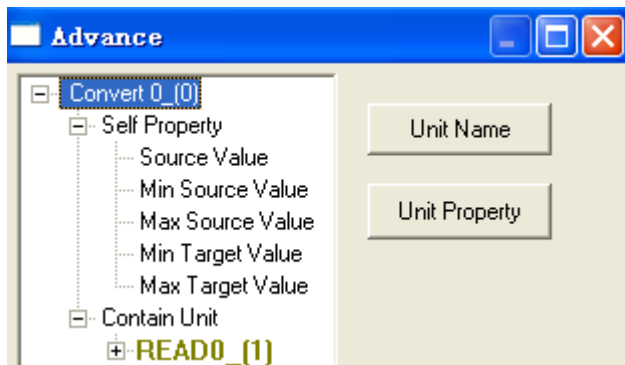

Step5: Double-click the “Write” component, here the modify type is register, object is D2 and data type is DWORD.

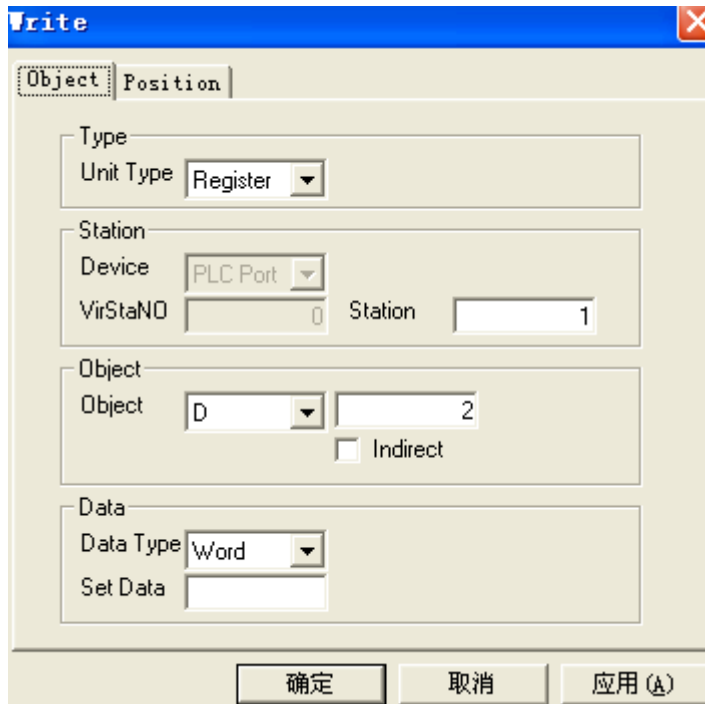

Step6: “Input value” of Write property contain “convert” component

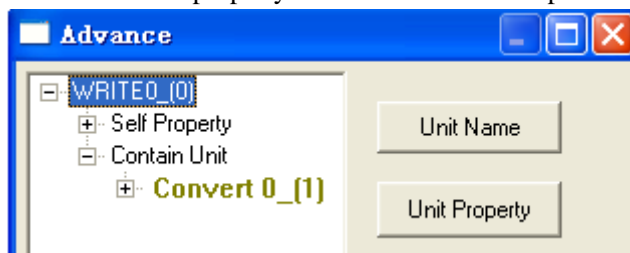

Step7: Put one “digital input” and one “digital display” on the screen, To “digital input”, the modify type is register, object is D0 , data type is DWORD and data format is “Float”, in the “Bit length” set “float” as 2 . To “digital display”, the modify type is register, object is D2, data type is DWORD and data format is “Dec”

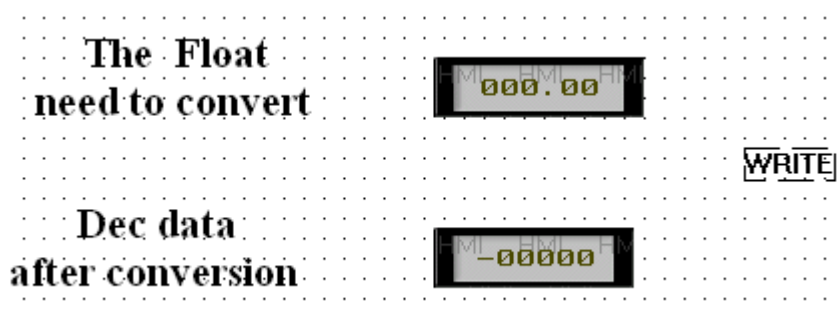

Step8: Trough “offline simulation” to observe the effects, enter “float data” in the Floating-point input box, immediately the Dec display box will display the converted Dec data .as follows:



The Float need to convert



Dec data after conversion



Example 2: The data range from 0 to 1000 stored in the D0 converted into the data range from 0 to 100, and stored in D2.

Step1: Placing one “read” , one “write”  and one “convert”  components on the screen, as follows:

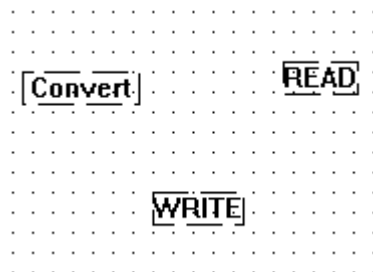

Step2: Double click “conversion” part, in the pop-up list, set source format and result format as “Dec”, To “source”, the upper limit is 1000, the lower limit is 0 , To “result”, the upper limit is 100, the lower limit is 0 .



Step3: Double-click the “Read” component, here the modify type is register, object is D0 and data type is WORD.

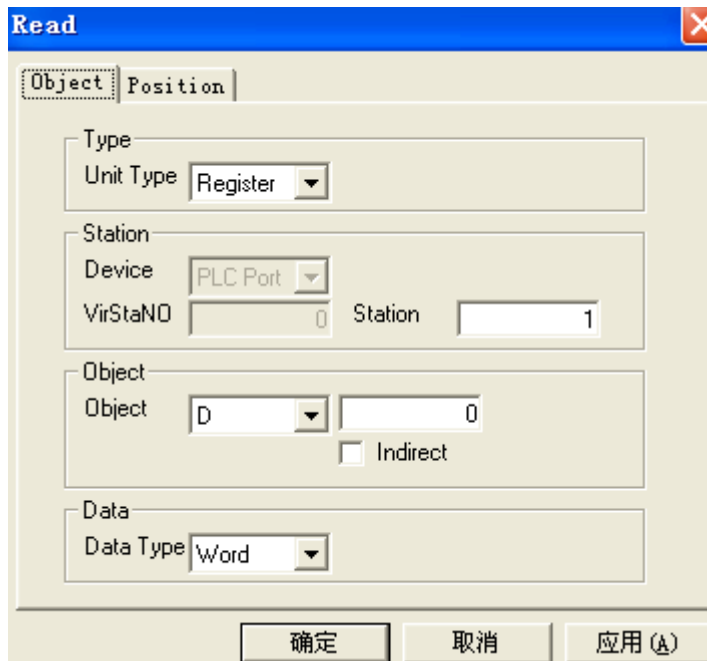

Step4: “Source value” of convert component property contain “read” component.

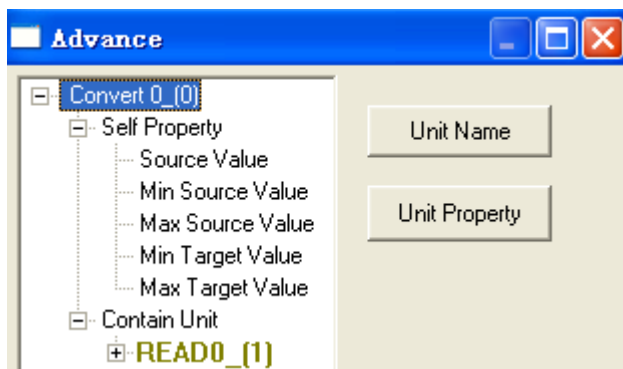

Step5: Double-click the “Write” component, here the modify type is register, object is D2 and data type is WORD.

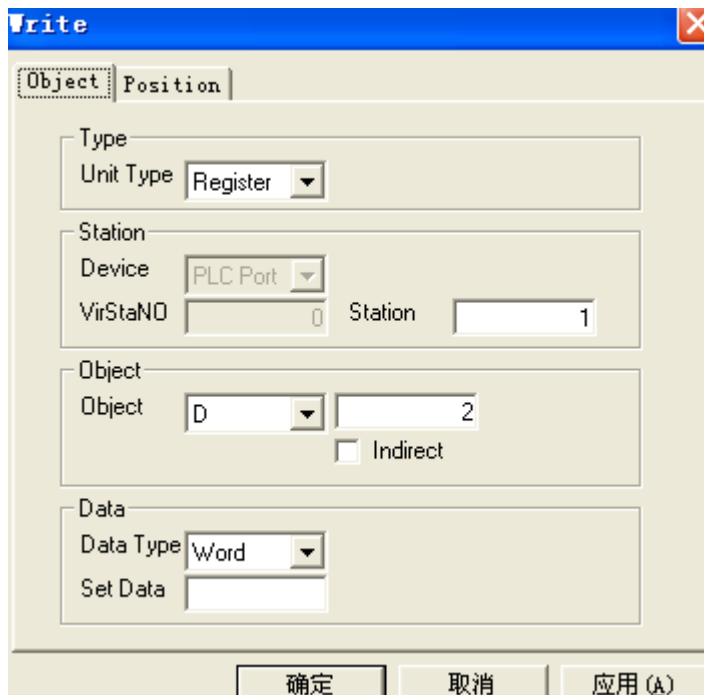

Step6: “Input value” of Write component property contain “convert” component

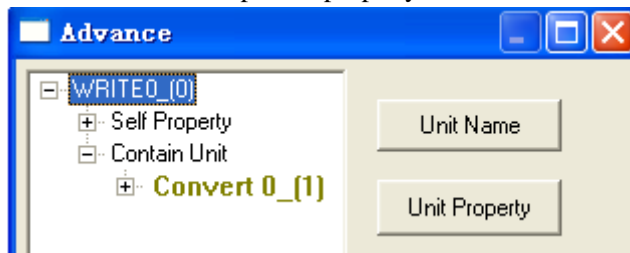

Step7: Put one “digital input” and one “digital display” on the screen, To “digital input”, the modify type is register, object is D0 , data type is WORD and data format is “Dec”. To “digital display”, the modify type is register, object is D2 , data type is WORD and data format is “Dec”

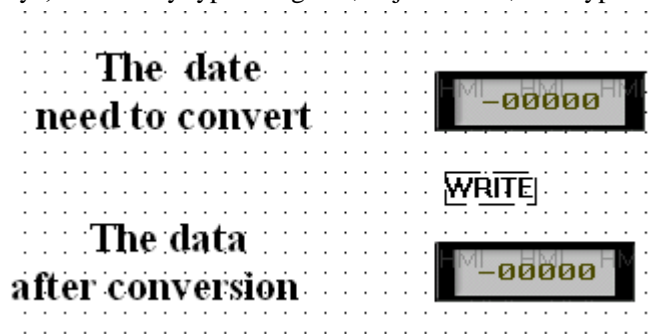

Step8: Trough “offline simulation” to observe the effects, enter “800” in the input box, immediately the display box will display the converted data “80”. As follows:

The date
need to convert





The data
after conversion



4.2.16 Range check FW

●**Overview:** Used with “read” unit, Check whether the range of data overrun and to implement the corresponding action.

Example: Check the data of D0 , when its value is more than 100, set M0, otherwise reset M0.

Step1: Placing one “IF”、one “read” 、two “write”  and one “range check”  components on the screen, as follows:

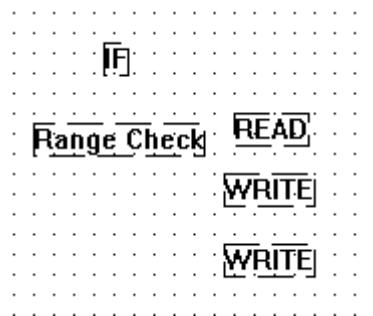

Step2: Double-click “range check” component, set Max value to 100 and set Min value to 0. as shown below:

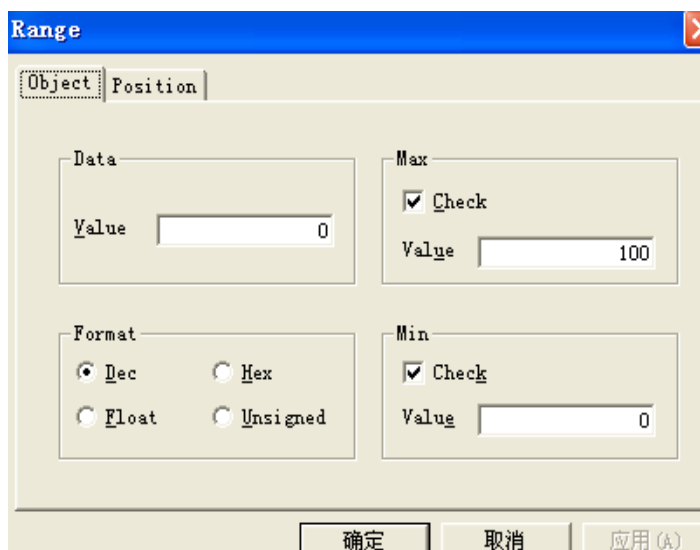

Step3: Double-click the “Read” component, here the modify type is register, object is D0 .

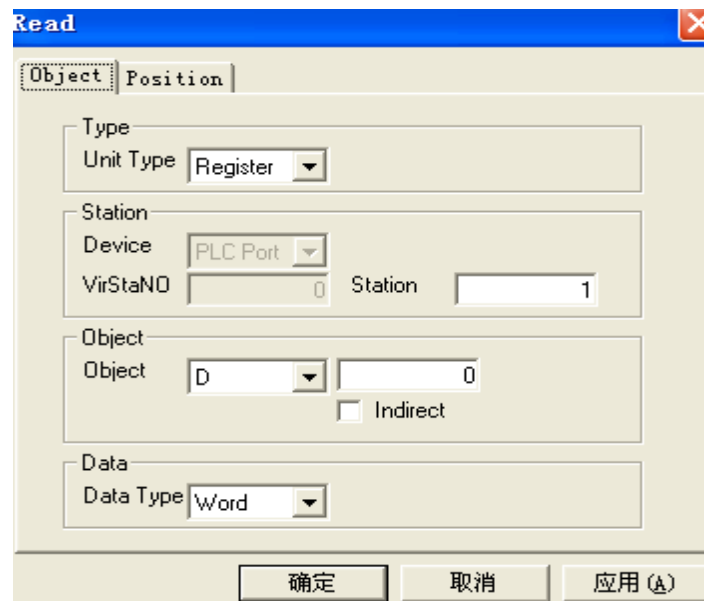

Step4: “Checking value” of “Range check” component property contain “read” component.

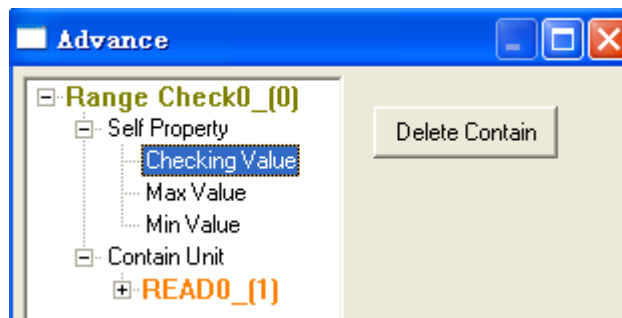

Step5: Double-click one “Write” component, here the modify type is bit, object is M0, “set data” is 1.

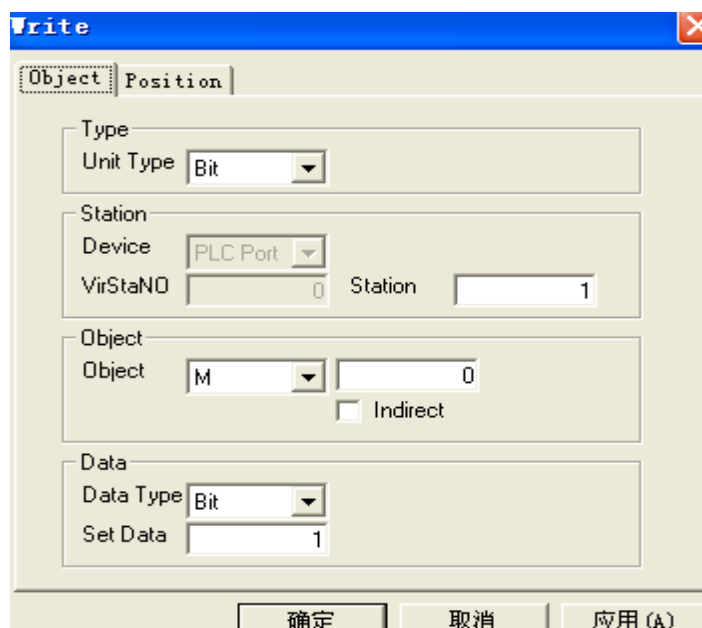

To the “write” component execute “insert unit” operation, as shown below:

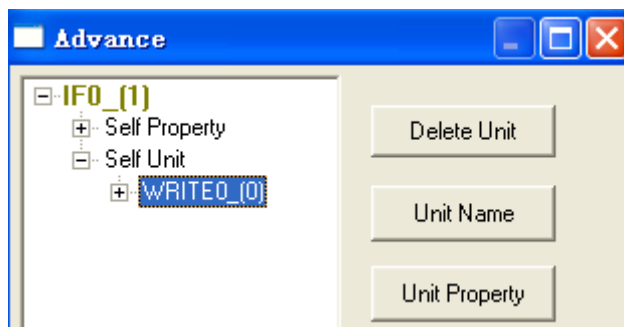

Step6: Double-click the other “Write” component, here the modify type is bit, object is M0, “set data” is 0.

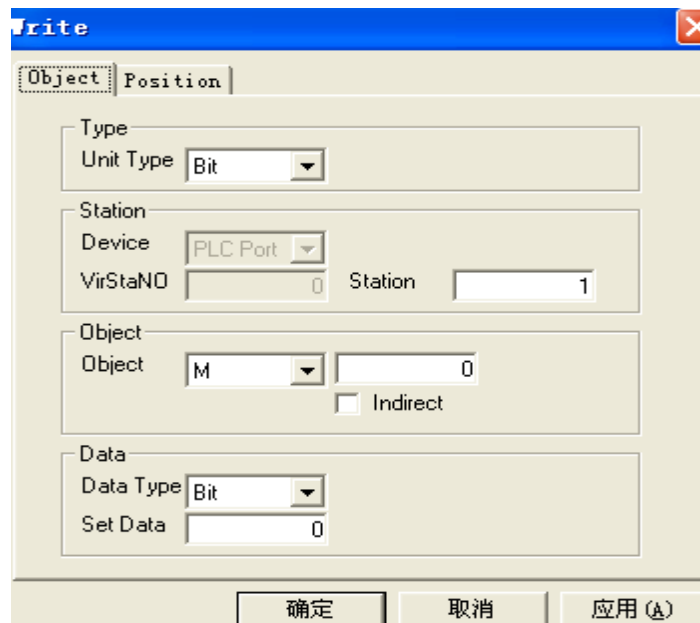

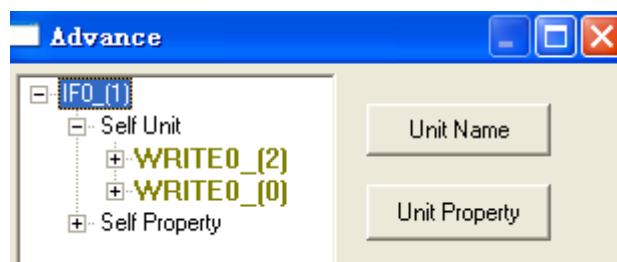

To the “write” component execute “insert unit” operation, as shown below:

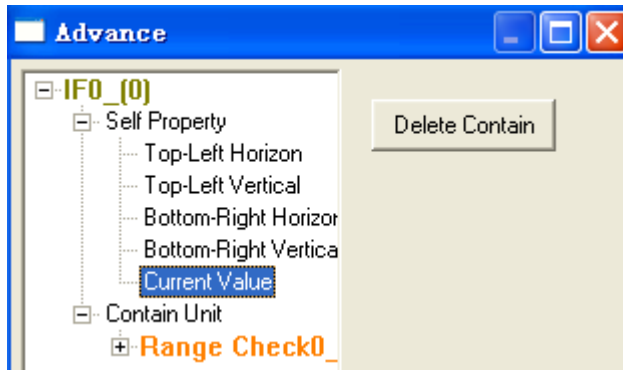

Step7: “Current value” of IF component property contain “range check” component.



Step9: Put one “lamp”  component and one “digital input”  component on the screen, To “lamp”, point object to M0, To “digital input”, point object to D0. as shown below:

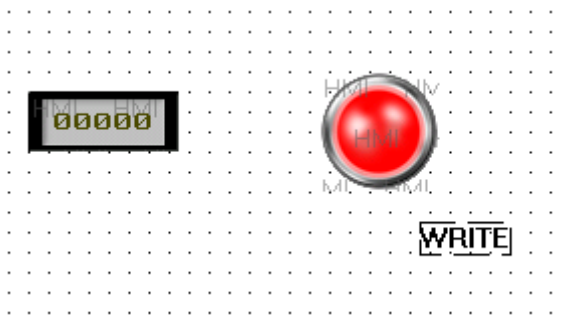

Step9: Download to the touch-screen, When the input data exceed 100 , the indicator light will light, when the value is less than 100 , the indicator light will OFF. The effect as shown below:



4.2.17 Key

Overview:

This component is the main part to make buttons, performing operations with Write and other component.

Example: make button with yourself , reverse M0 on released state, the date of register D0 self plus one on pressed state, set M1 on releasing state, reset M1 on pressing state.

Step1: choose one key、two function filed、two write on the screen, and pulling the button to the touch size you need.

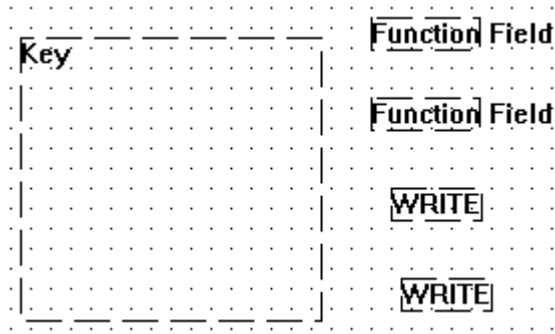

Step2: Use the rectangle, the text string composed of the following graphics, This will serve as a key shape (Note: You can also use beautifully produced picture), In order to facilitate distinction, Let us put these graphics from left to right named as graphic 1、 graphic2、 graphic3、 graphic4.

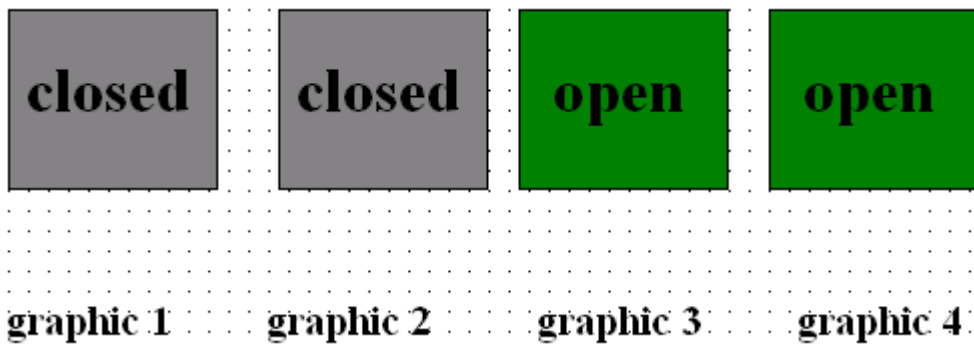

Step3: Double-click one of the function filed components, act mode select as “continue”



Step4: Adding function: reverse M0

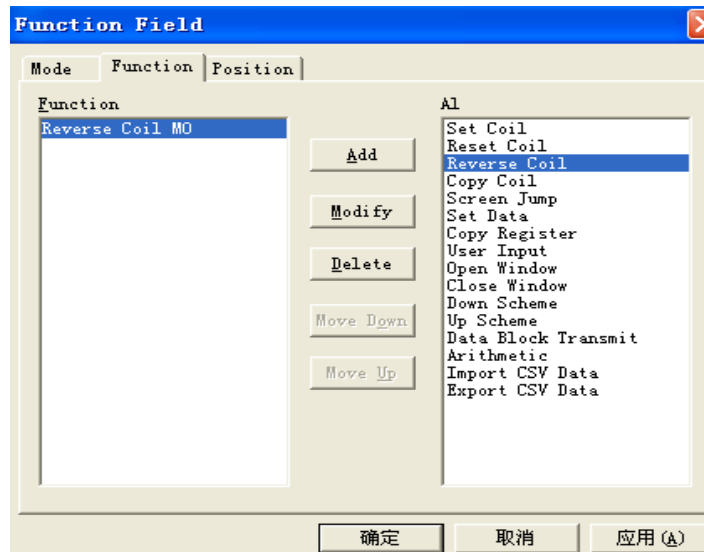

Step5: After finishing function filed production, Because the operation of reverse M0 is carried out under released state of key, so the state of key should be closed, it should be a combination of function filed and graphic 1 into a component .

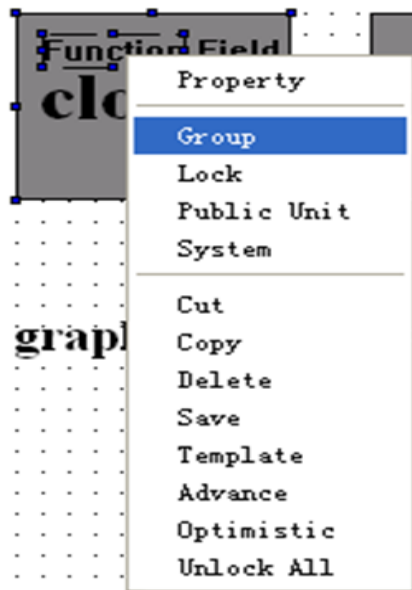

Step6: Double-click the other function filed component, act mode select as “continue”, then adding function: arithmetic $D0=D0+1$

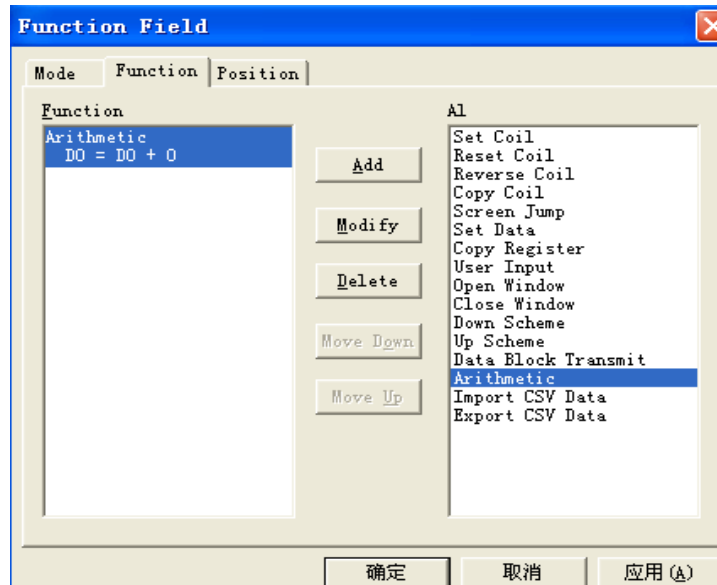

Step7: The operation of D0 self plus one is carried out under pressed state of key, so the state of key should be open, it should be a combination of function filed and graphic 3 into a component .

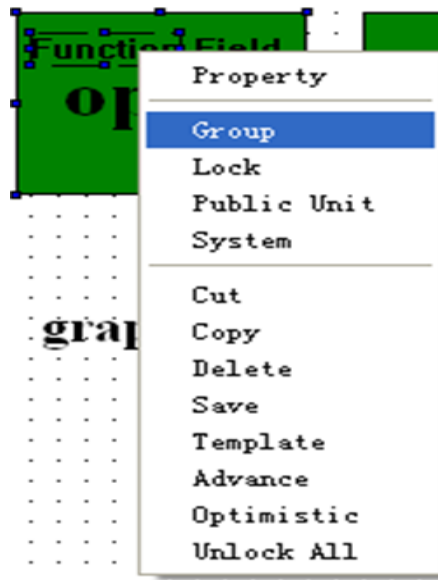

Step8: Double-click one of the “write” components, point object to M1, Set Date as 1.

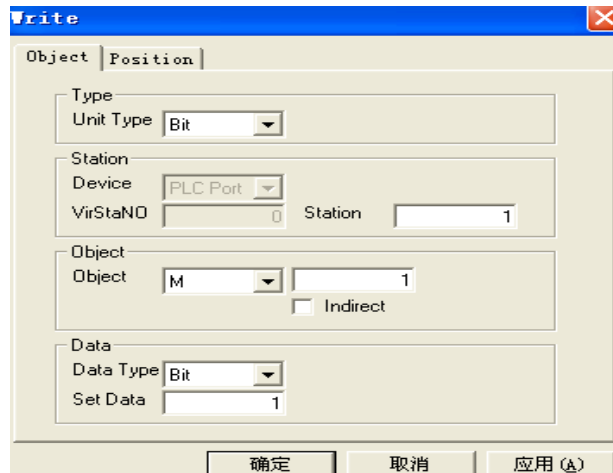

Step9: The operation of Set M1 is carried out under pressing state of key, so the state of key should be open, it should be a combination of function filed and graphic 4 into a component .

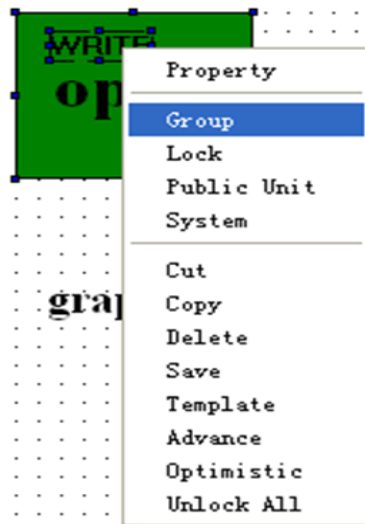

Step10: Double-click the other“ write” component , point object to M1, Set Date as 0

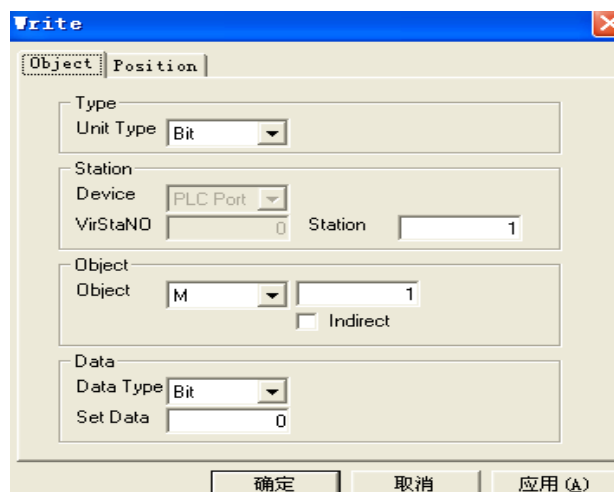

Step11: The operation of reset M1 is carried out under releasing state of key, so the state of key should be closed, it should be a combination of function filed and graphic 2 into a component .

Step12: To the above four generated groups execute the insertion operation on the button, as the following diagram:

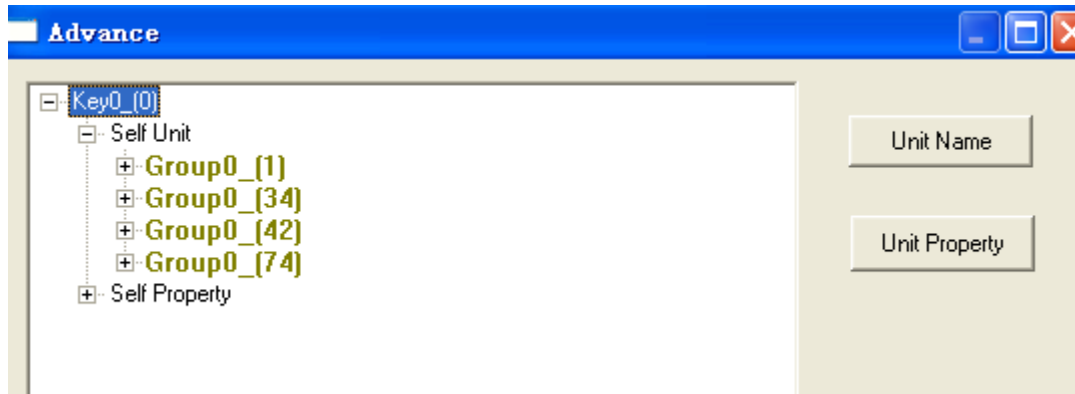

In the above diagram, you can see under the key's self unit shows just inserted four components ,up and down the relationship between them are fixed, respectively, from top to bottom represent the four kinds: released、 pressed 、 releasing、 pressing . Therefore different sequences represent button in the corresponding states will perform different actions. (Note: up or down through the component to change the sequence of state between the components) ,In addition, the number of components can not exceed 4, if necessary, in some key state to execute multiple functions, then these parts need to be combined into a group to execute insertion action. Finally, placing a M0 indicator light 、 M1 indicator light 、 D0 digital display on the screen , Download programs to the touch-screen.

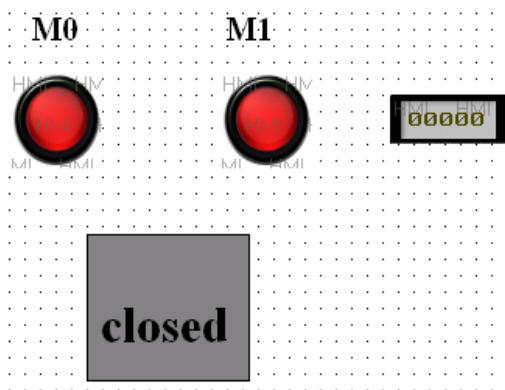

When there is no pressed button, Since the released state carried out reverse M0, Therefore, the indicator light of M0 flashing all the time. When pressed the button, Button color from gray to green, and M1 of the indicator light, the date in input box is increasing, when release the button, the indicator of M1 will Off, the date in input box will stop increasing.

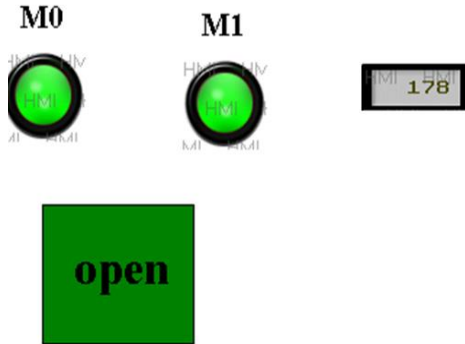

4.2.18 RTC set clock `rtc`

- **Overview:**

(Year / month / day / hour / minutes / seconds) RTC component used with READ, the user can directly modify the Time of touch-screen.

- **Routine:** Through D0 to modify the month of touch screen

Step1: Put RTC and READ in the screen

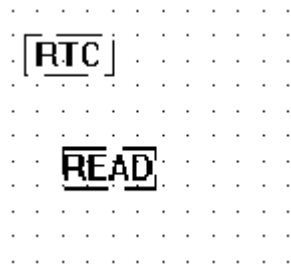

Step2: Double-click the RTC component, set `Kind` as `Month`.

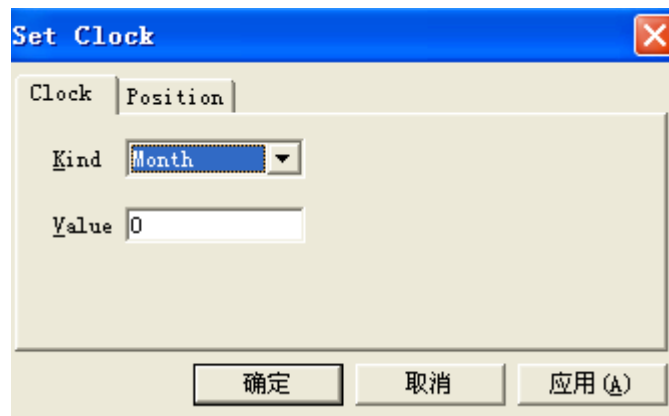

Step3: Double-click READ component, point object to D0.



Step4: The operand of the RTC property contain READ component.

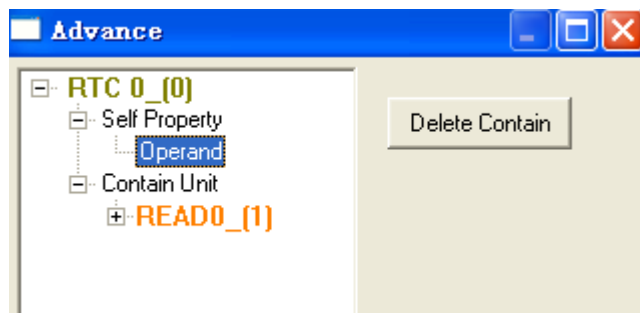

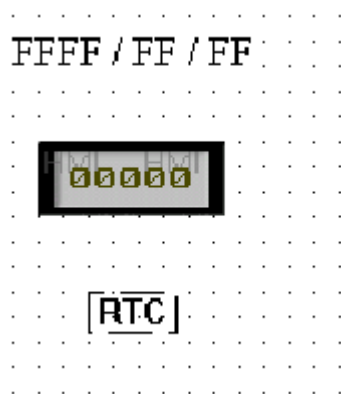

Step5: Put one digital input component and Data in the screen. As follows:

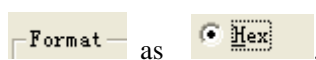

Step6: Double-click digital input component, point object to D0, in the Display option, select

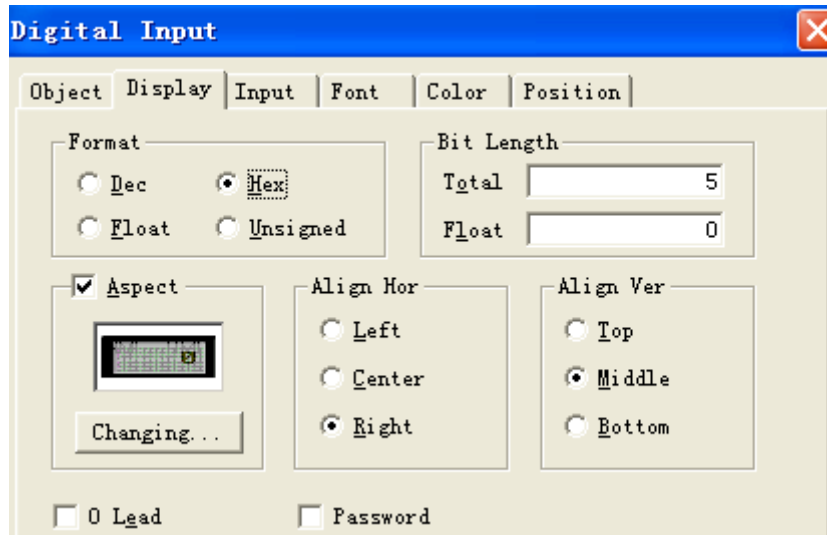



Step7: Click the “off-line simulation” icon on the software , See the following simulation results:

Touch-screen time displayed 2010/01/13, when enter 12 to the D0 data input box, and then the time will immediately changed to 2010/12/13. Through the above approach we can create components which can modify year, day, hour, minutes and seconds.

2010 / 01 / 13



2010 / 12 / 13



4.2.19 “Read”

- **Overview:**

“Read” component is used to achieve data-read function, can be used to read bit state or value of one or more registers. The device is usually used to provide the data source for other advanced components.

Its advanced properties shown as the following diagram:

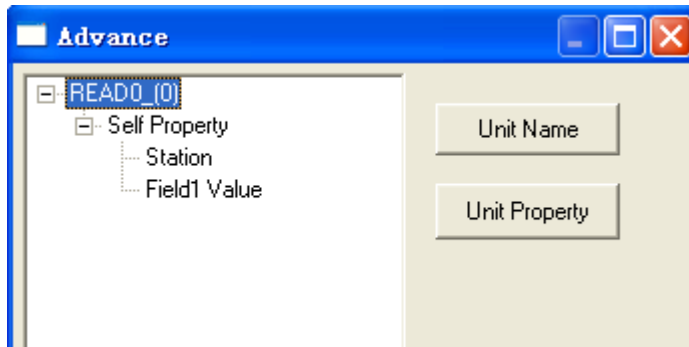

- Station: When there are multiple external devices connected, you can choose different devices.
- Field1 value: Can select different objects address number

Component property:



- Type: Manually select Bit、 Register or nRegister。
- Station: When there are multiple external devices connected, you can choose different devices.
- Object: Manually specify the object type and address number which need read.

Note: Although in the advanced properties, Station and Field1 value of “read” component can use two respective registers to select indirectly, but it would greatly increase the traffic capacity, reduce operating efficiency. So, be sure to manually specify device Station and object address in “Read Property” immediately .

4.2.20 “Write” 否

• Overview:

This section will introduce advanced directive “write” component, users who understand the C language, should know C language has a Read and write capabilities, the following “write ”component is equivalent to write function of C

language , will be introduced in the equivalent of C language to write functions. write instruction is very widely used in advanced directives, for example: the basic components in the software ,the user can use function button or function filed to clear one or more registers or copy to another area, write also can use read element to achieve the above functions, the following will introduce the functions and usage .

Property Description :

Write is to write the data to the appropriate register.



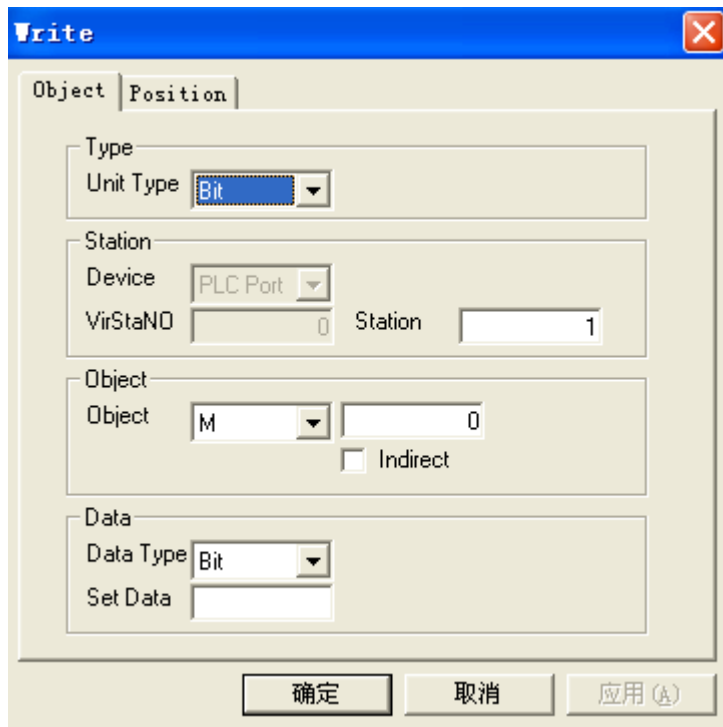

Put one “write”  on the screen; open its property dialog box, as shown below:



•Routine

The routine focuses on through Write instruction and read instruction to achieve clearing one or more registers or copy to another registers. Steps are as follows:

Step1: building a screen, placing parts

Building a new screen, placing the following components on the screen: two text  , one digital input  , one digital display  , one Read  and one Write  . as follows:

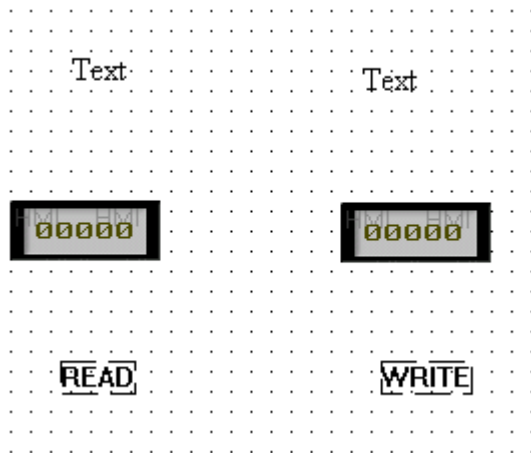

Step2: Modify properties

1. Double-click the left "Text" to open the Properties dialog box, In the text editing area, enter the following text:



2. Double-click the right "Text" to open the Properties dialog box, In the text editing area, enter the following text:



3. Double-click “digital input”, open the Properties dialog box, in **Object** option , modify object to PSW300, as follows:

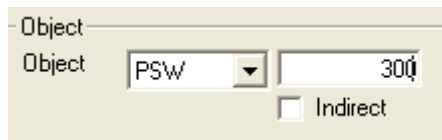

4. Double-click “digital display”, open the Properties dialog box, in **Object** option , modify object to PSW302, as follows:



5. Double-click “Read”, open the Properties dialog box, in **Object** option, modify object to PSW300, as follows:

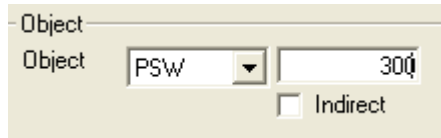

6. Double-click “Write”, open the Properties dialog box, in **Object** option , modify object to PSW302, as follows:

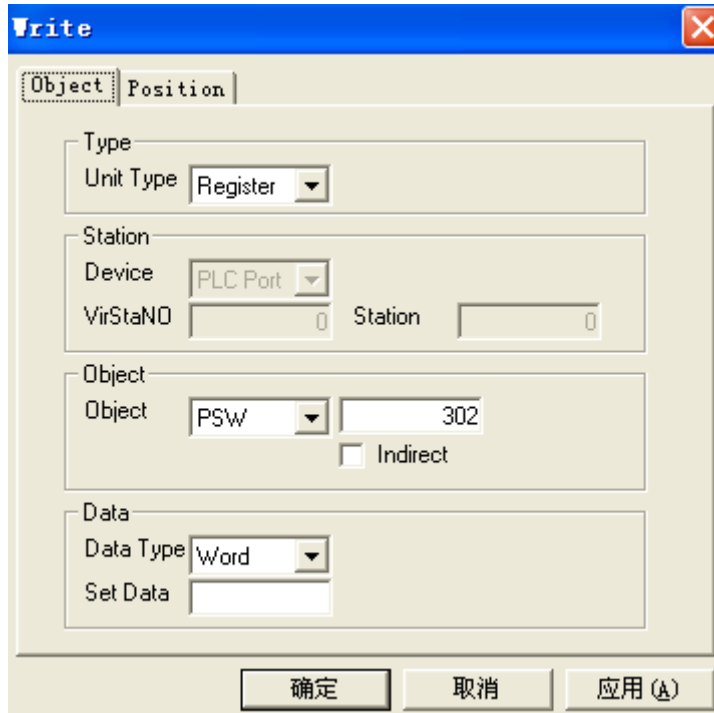

Step3: Advanced Operations

1. Select Read and Write at the same time, Right-click the selected area, choose Advanced, as follows:

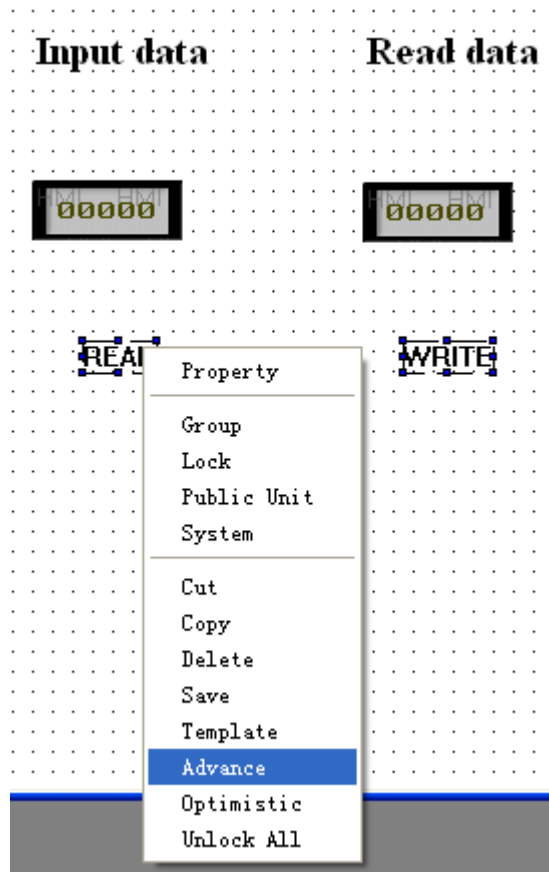

4. Pop-up the following advanced dialog box, Click the small plus sign \oplus in front of directive \oplus **WRITE0_1** , Successively click the front plus sign \oplus , open \oplus **WRITE0_1** directive's self property, then select "**Input Value** ", as follows:

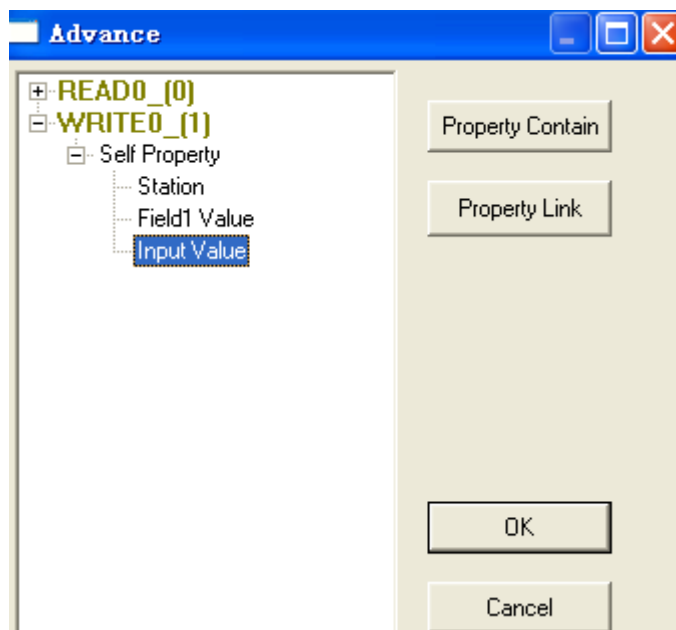

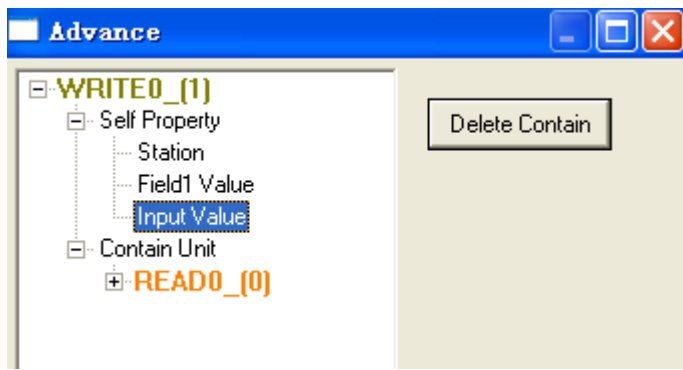

4. Click **Property Contain** → select \oplus **READ0_0** → click **Affirm Contain** , the final

effect are shown below:

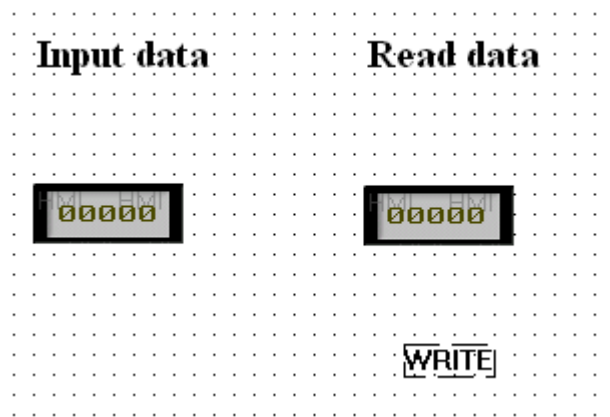

5. Click “OK” to complete advanced operation.



6. Click the “off-line simulation” icon on the software , See the following simulation results:

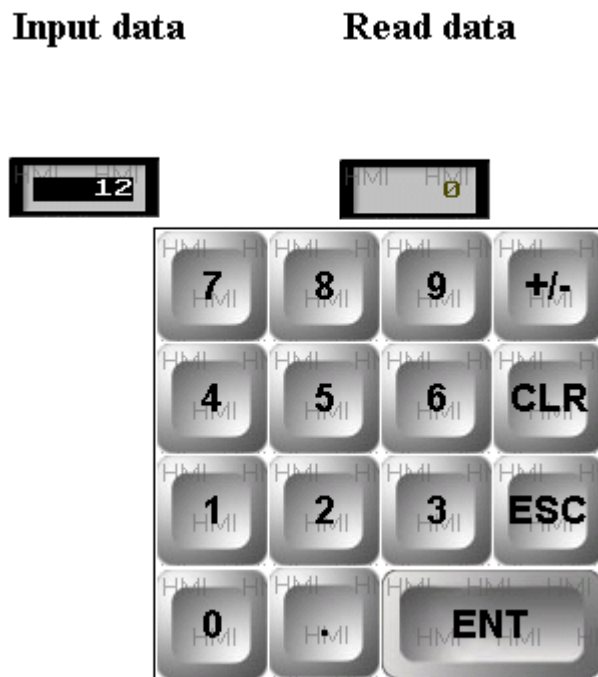

Input data



Read data



4.2.21 Block

- **Overview:**

In practice application, Block directive is useful to dynamic flow chart, Water tank, stick figure, the dynamic part are composed of block instruction with other advanced components, the following, we will introduce the properties of block and functional use.

Property Description:

1. Click  icon, put one Block component on the screen, Double-click Block component, Open the Properties dialog box, as follows:

Block option:



Color option:

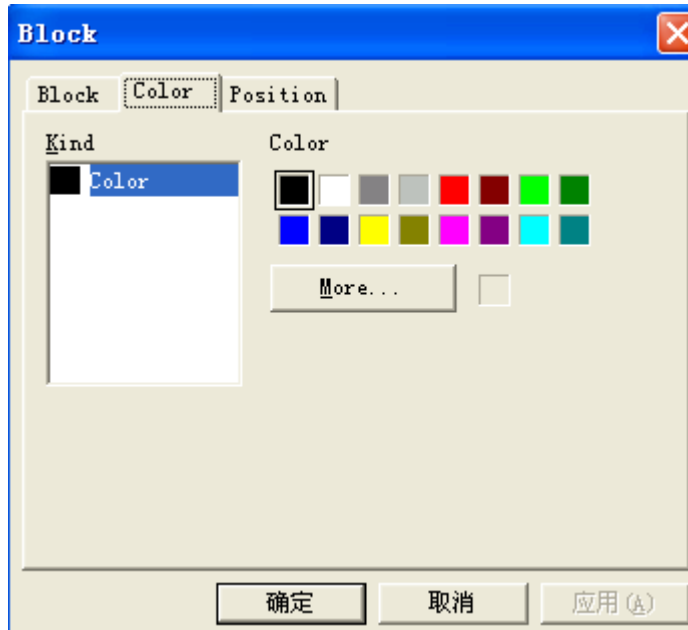

Position option:

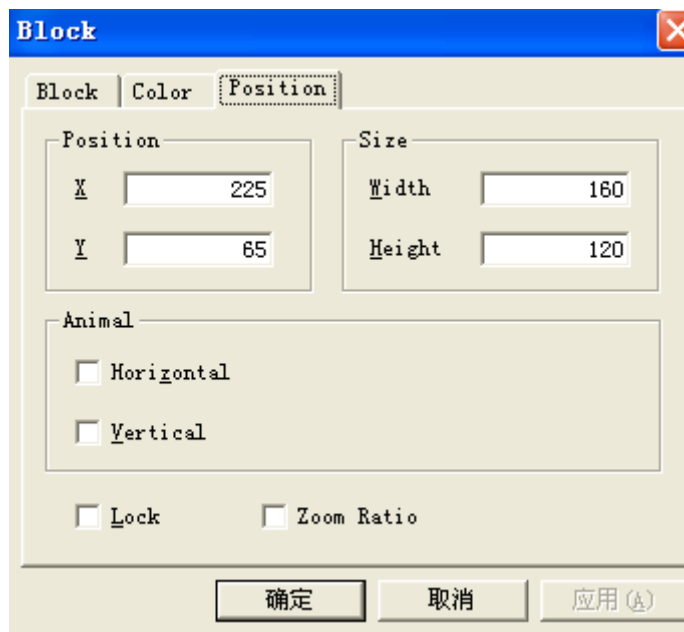

● **Functional introductions and use.**

Here through create a Water tank to explain block component's functional use.

Step1: building a screen, placing parts

Building a new screen, placing the following components on the screen: two rectangle  , one

Block  , one "Rotate Animal"  , one scale  , as follows:

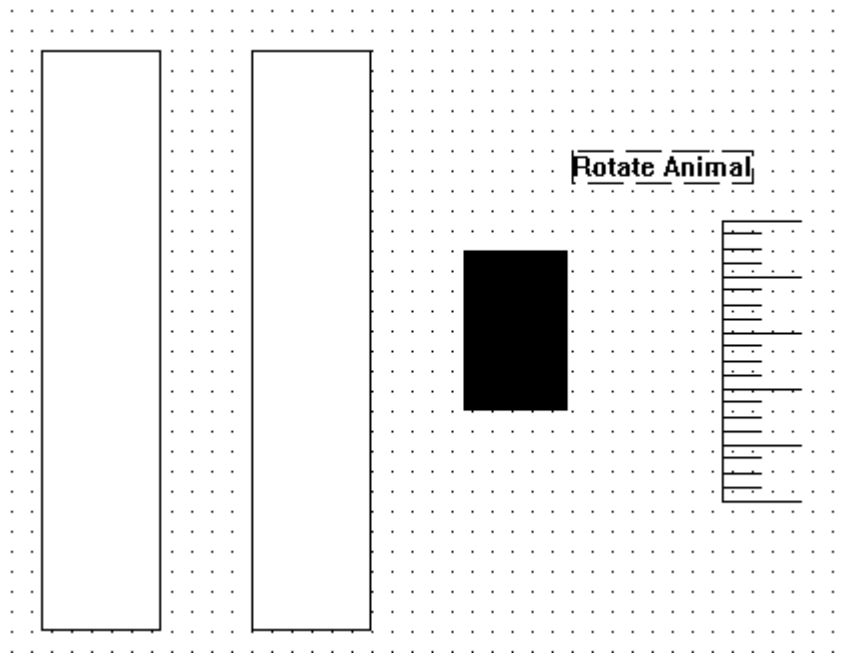

Step2: Modify properties

1. Double-click the left “rectangle”, open the Properties dialog box, in **Fill** option, select “linear”, as the following settings:

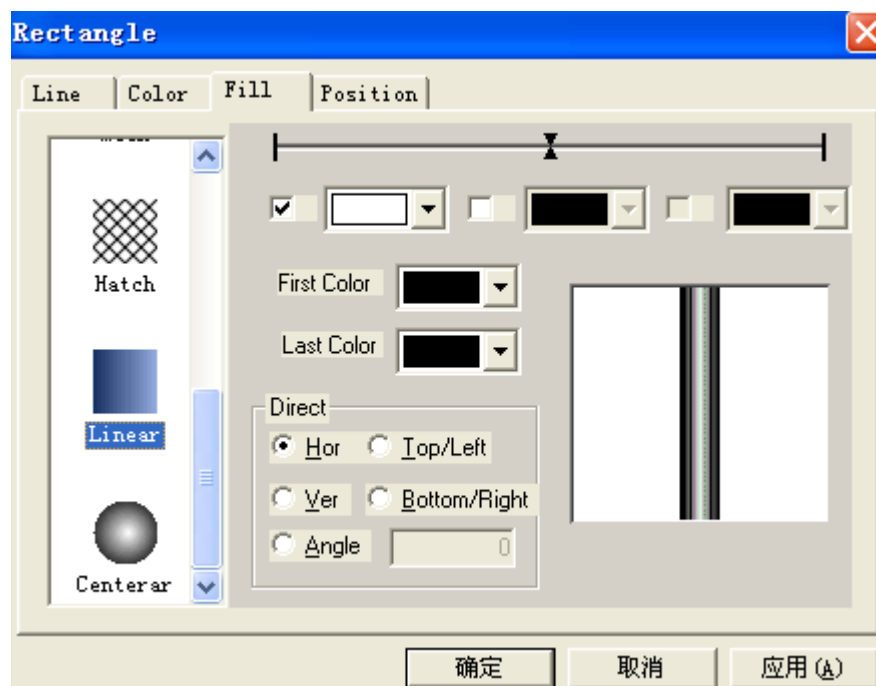

2. Click “OK” button, Results are as follows:

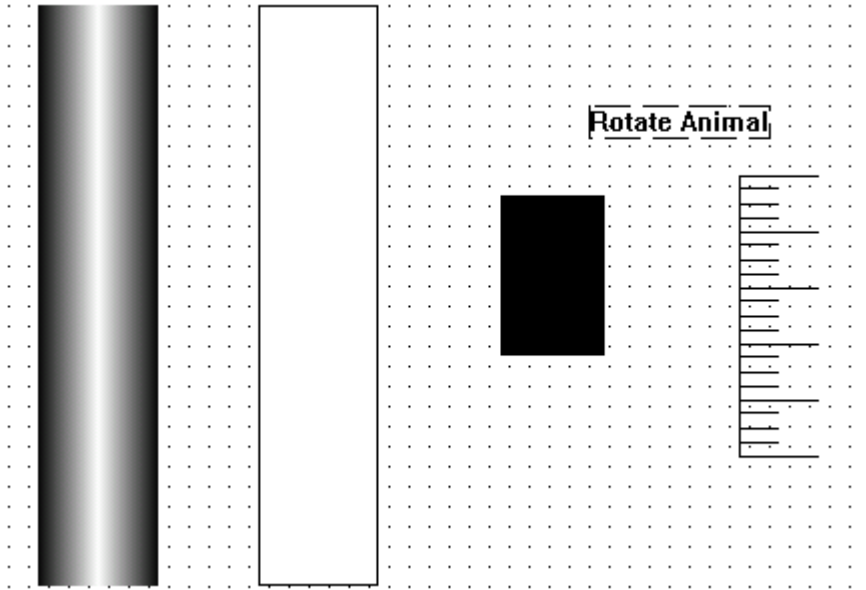

3. Double-click the right “rectangle”, open the Properties dialog box, fill mode is the default Solid mode, set color as blank, as the following settings:

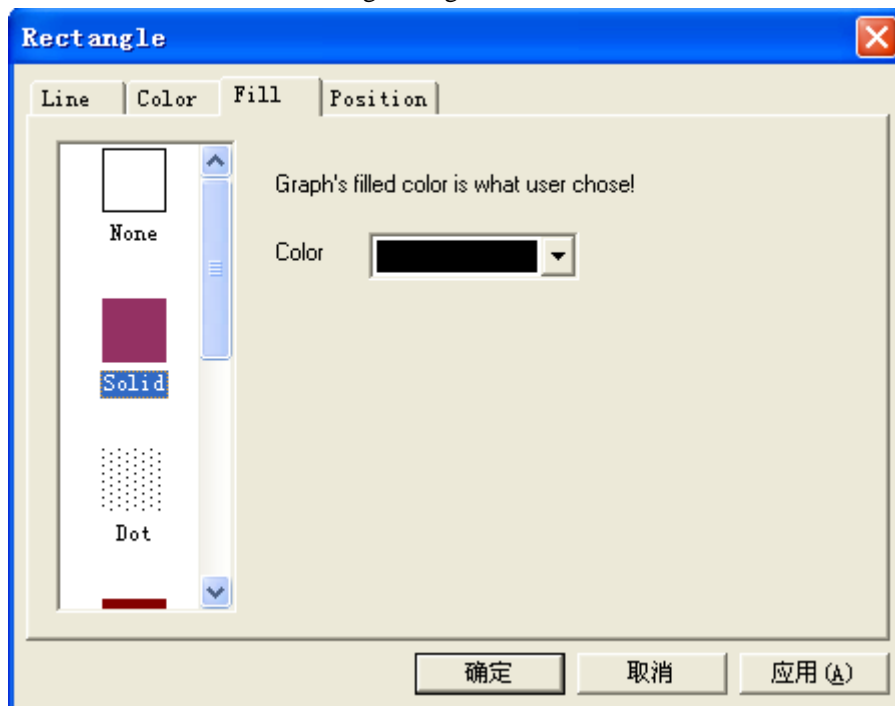

4. Click “OK” button, Results are as follows:

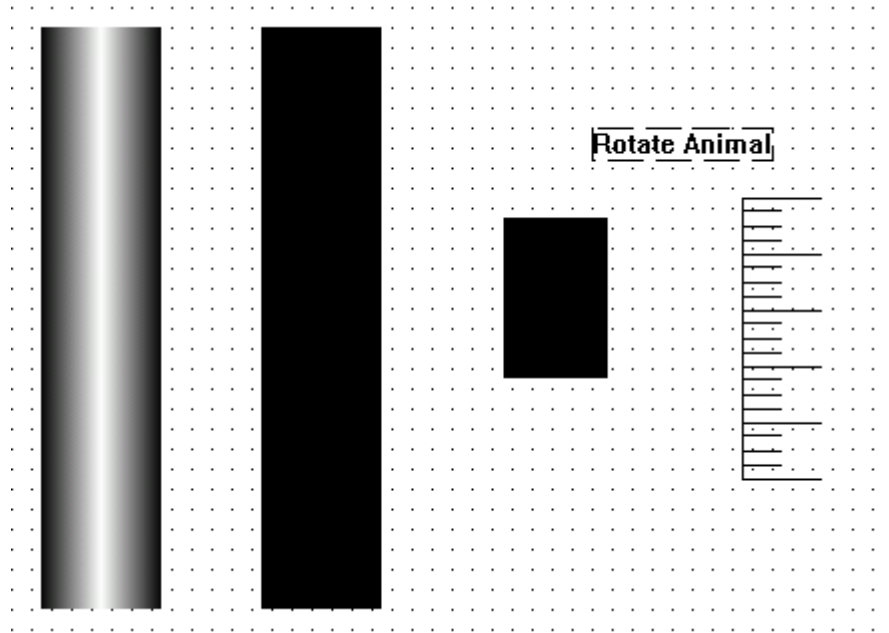

5. Double-click “Block”, open the Properties dialog box, click position option, set **Width** as 50, set **Height** as 325, as follows:

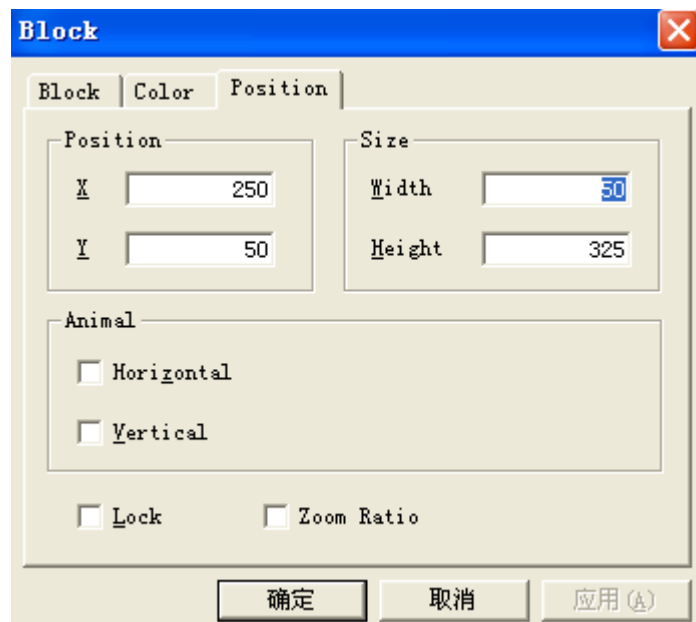

6. Click **Block** button, set **Align Ver** as **Bottom**, set **Width** as 50, set **Height** as 325, as follows:



7. Click **Color** button, set color as  **Color**, as follows:

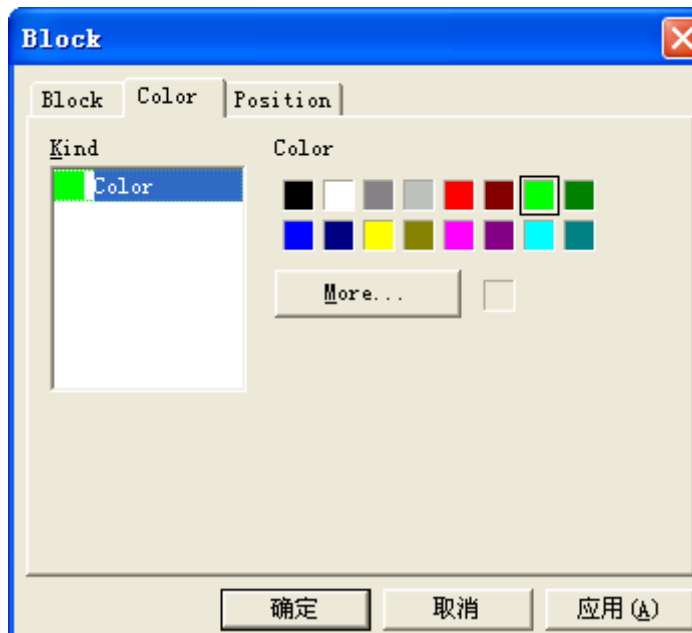

8. Click “OK” button, Results are as follows:

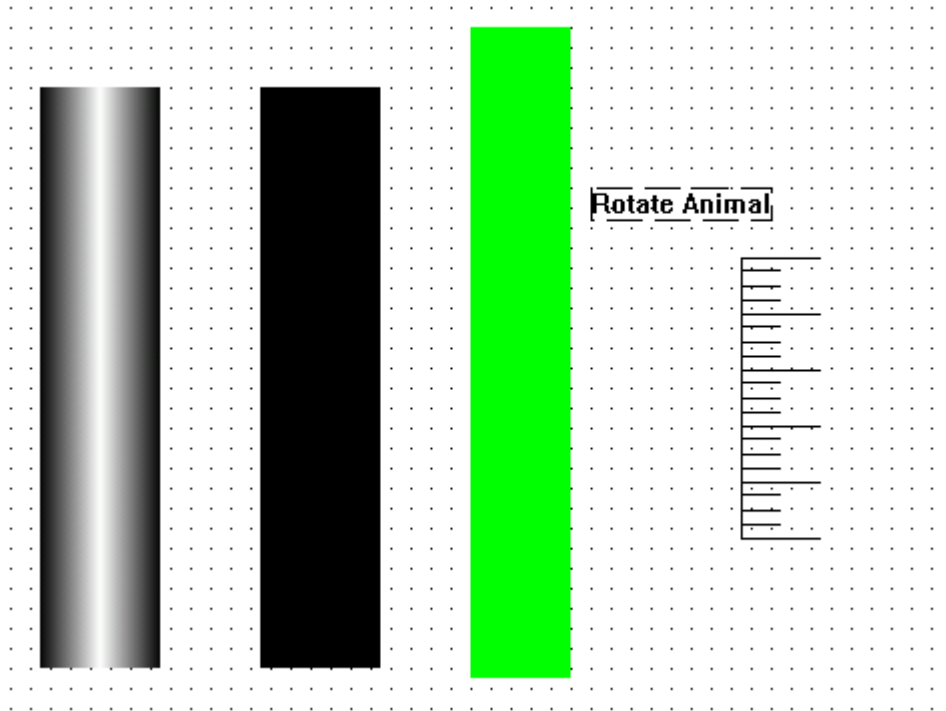

Note: ① The block size can be set according to the size of left side rectangle.

② When set block attributes, user should first set up **Width** and **Height** in the position option, then set up **Width** and **Height** in the Block option, On the contrary, can not be set to the desired results, the user can try.

9. Double-click “Rotate Animal”, open the Properties dialog box, set **Period** as 10000, set **End** as 325, finally click “OK” to complete the setting, as follows:



10. Double-click “Scale”, open the Properties dialog box, set **Main** as 5, set **Slave** as 5, set **Color** as black, as follows:

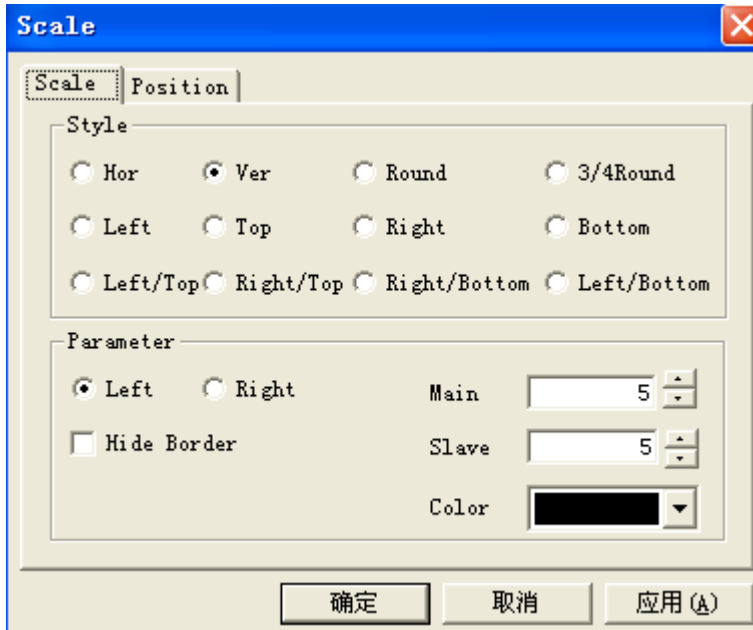

Step2: Advanced Operations

1. Select the “Block” and “Rotate Animal ” at the same time, Right-click the selected area, Pop-up the following dialog box :

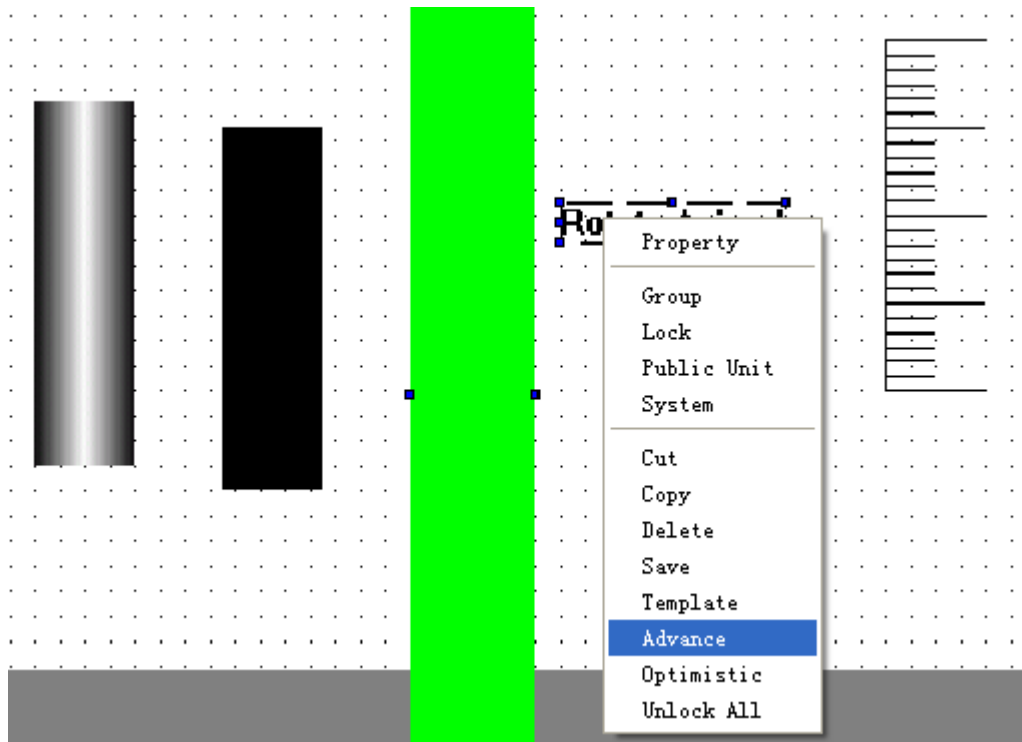

2. choose Advanced, in the advanced dialog box , Click the plus sign \oplus in front of **BLOCK 0_[1]** , then click the plus sign \oplus in front of Self Property , open its self property., as follows, select **Block Height**:

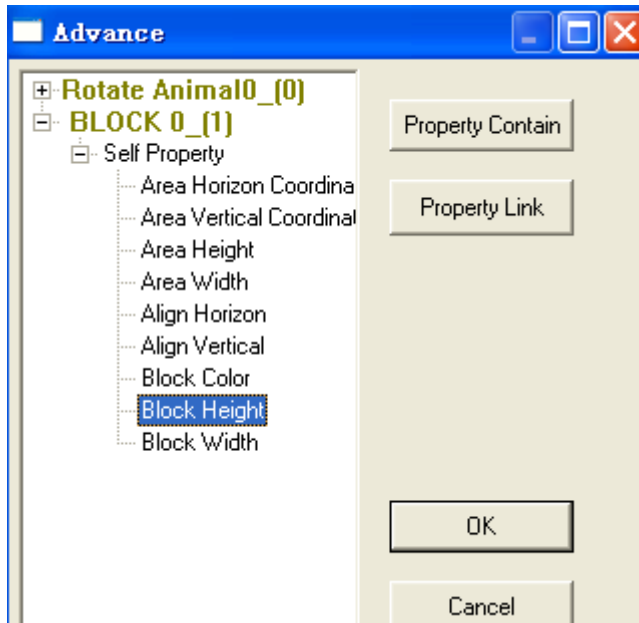

- Click the right button **Property Contain** in the dialog box, the button will be grayed-out non-operational status, while text changed into “affirm contain”, as follows:

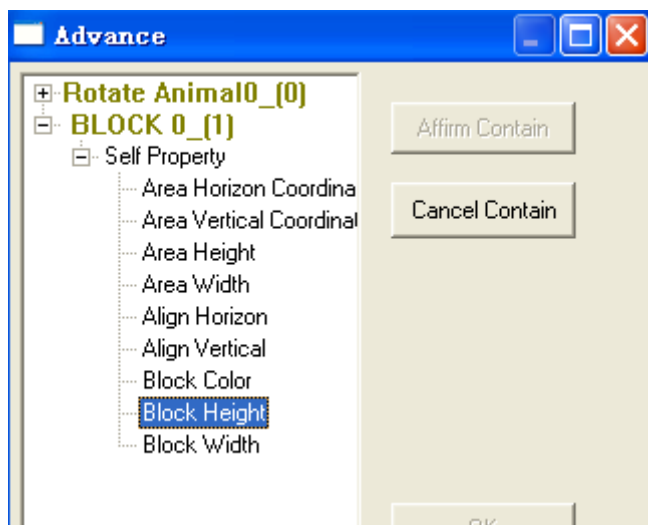

- Select **Rotate Animal0_(0)**, button **Affirm Contain** immediately changed into operational status, as follows:

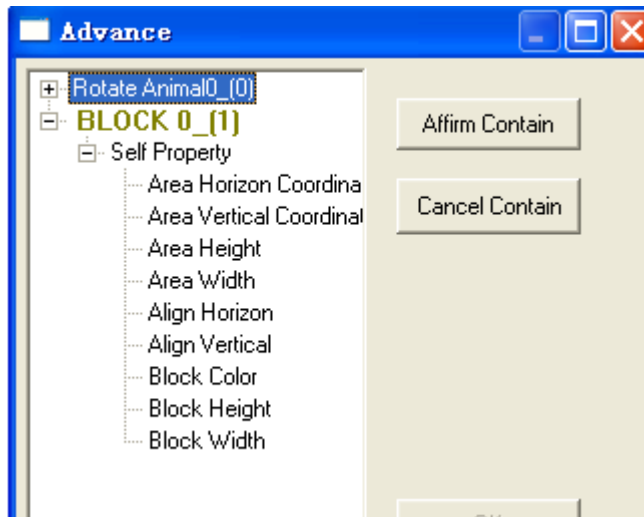

4. Click **Affirm Contain** button, complete property contain. As follows:

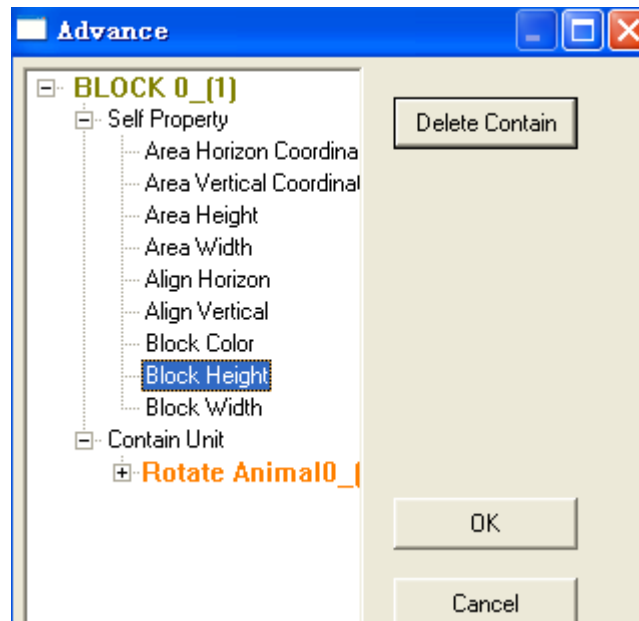

Step4: Combination.

1. Select the right rectangle then drag it to the left rectangle , as follows:

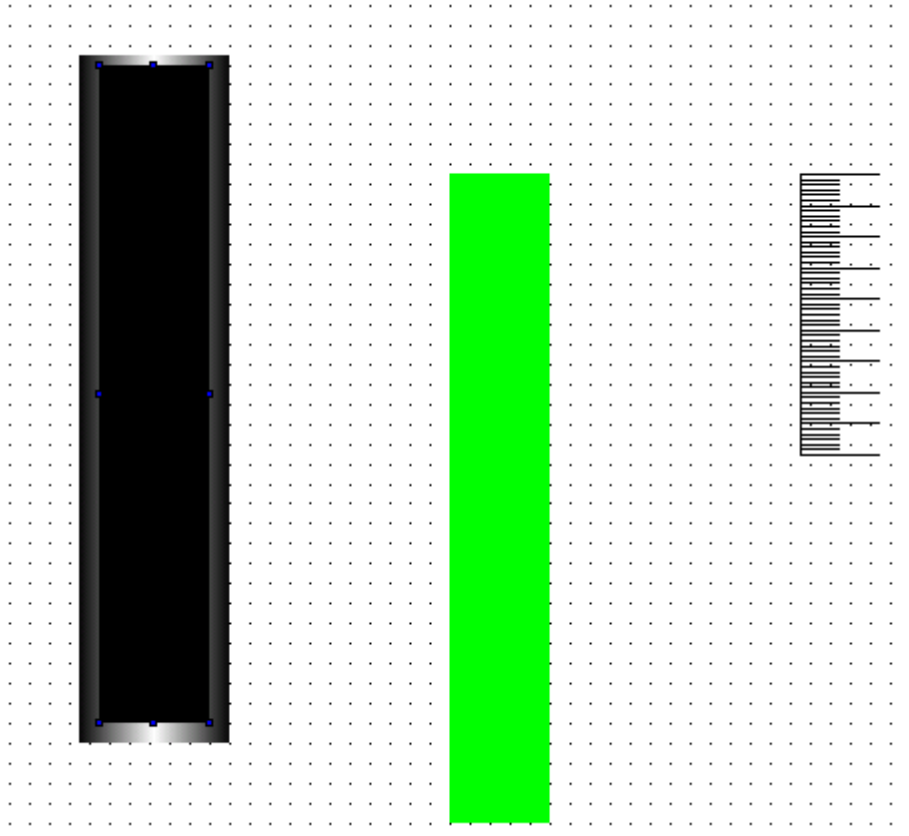

2. Select “Block” then drag it to the second rectangle , adjusted to the appropriate location , as follows:

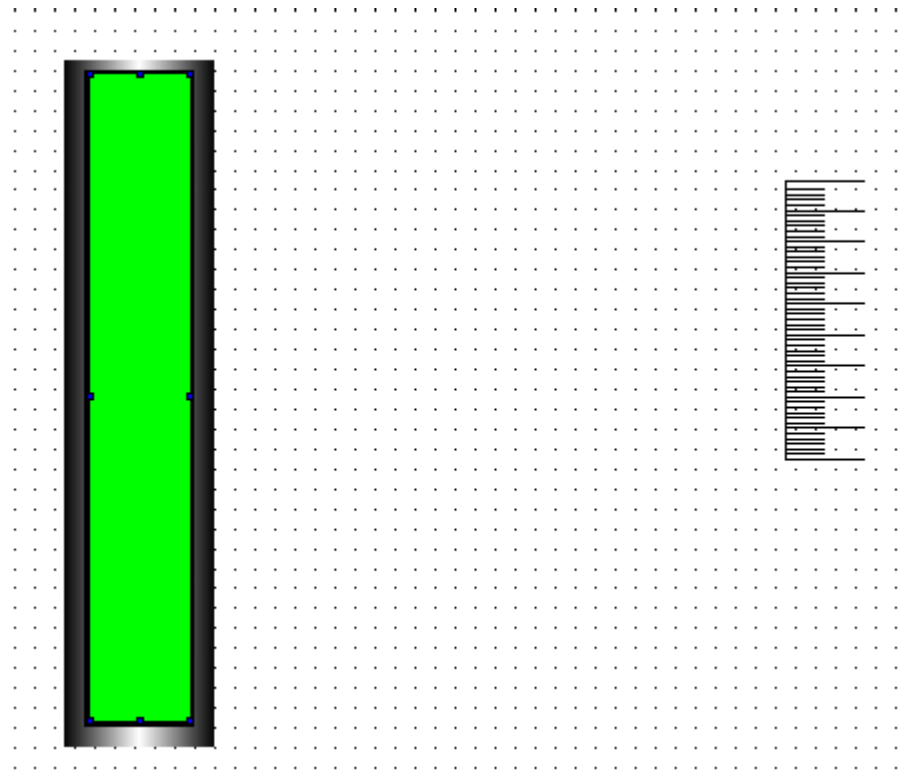

3. Select “scale”, drag it to Block, But can not see the scale component, as follows:

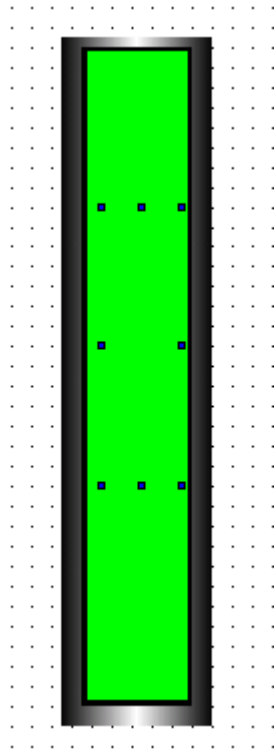

4. Do not release the mouse, Right-click, in the pop-up dialog box , select **Bottom Layer** , as follows::

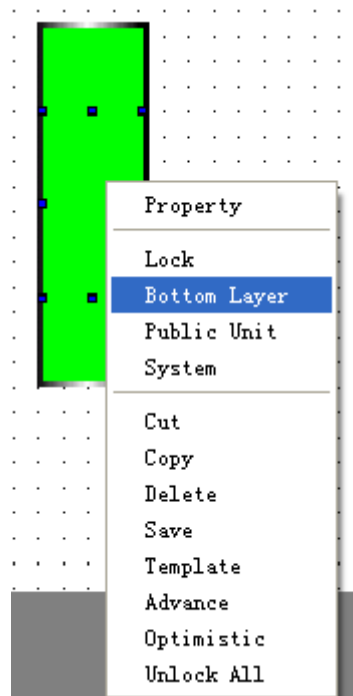

5. Then you can see the scale component:

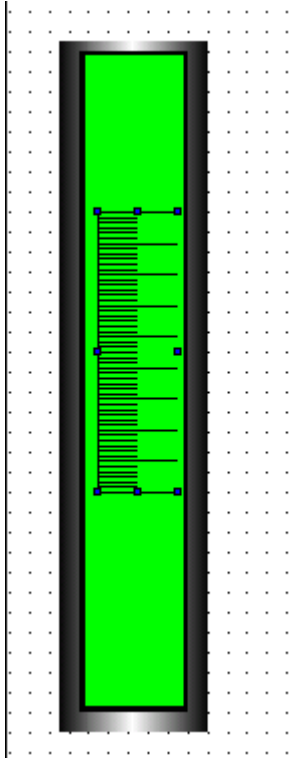

6. Select the scale component, adjust the size of the scale, and placed it in a suitable location, as follows:

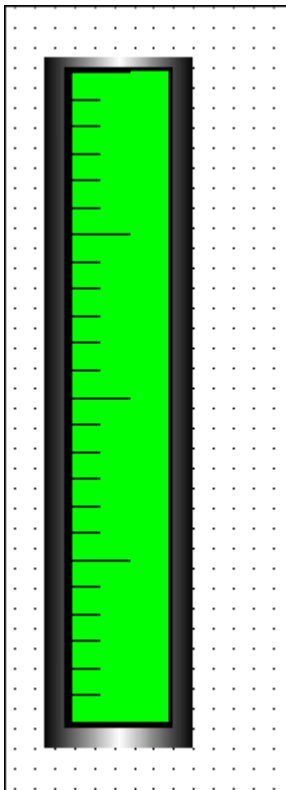

7. Thus a simple bar graph production is completed, Click the “off-line simulation” icon on the software , See the following simulation results:



4.2.22 Count CT

- **Overview:**

Counter is used to pulse counting device, when the count reaches the set value, the counter state to ON, to counter a reset pulse signal, counts will be cleared, while the counter state to OFF.

Timing diagram is as follows:

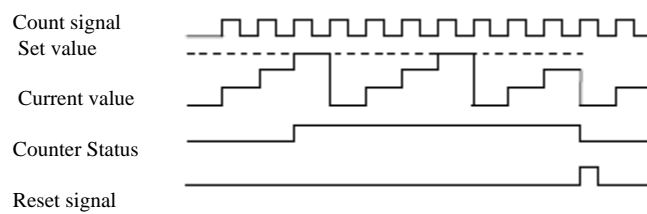

Advanced property:

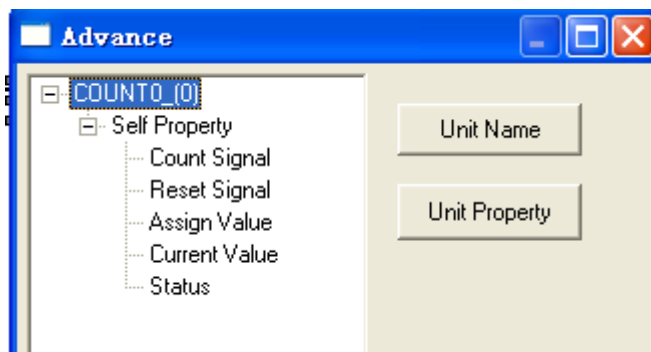

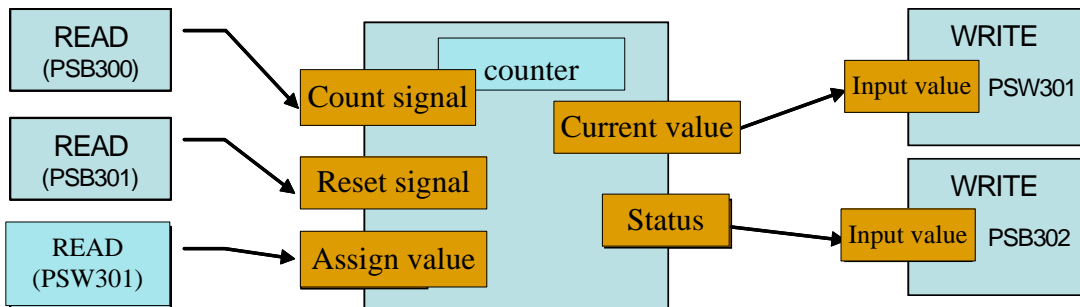

- Count signal: Count pulse signal.
- Reset signal: Reset pulse signal.
- Assign value: Count set value (can be specified with register)
- Current value: Current count value (which can be used to monitor counter state)
- Status: Counter current state (up to assign value / does not meet the assign value)

Example: Set PSW300 as the source of assign value , PSB300 and PSB301 respectively as the count signal and reset signal source. PSW301 as the current value display , PSB302 to reflect the counter status.



Composition diagram

Step1: Building a screen, placing parts

1. Building a new screen, placing the following components on the screen: three “read” , two “write” , one “count” , as follows:

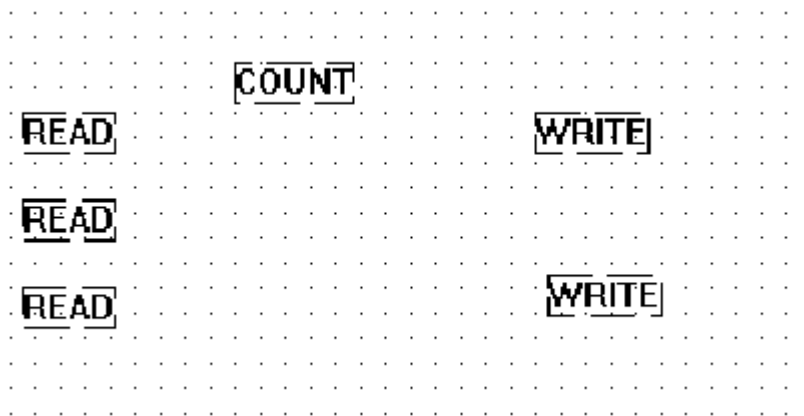

2. As the following set: 3 "read" components point separately to PSB300, PSB301, PSW301. 2 "write" elements are point separately to PSB302, PSW301.

Step2: Advanced Operations

1. Select the three “read” and the “count” component at the same time, Right-click the selected area, In the Pop-up dialog box ,choose Advanced, advanced dialog box as shown below:

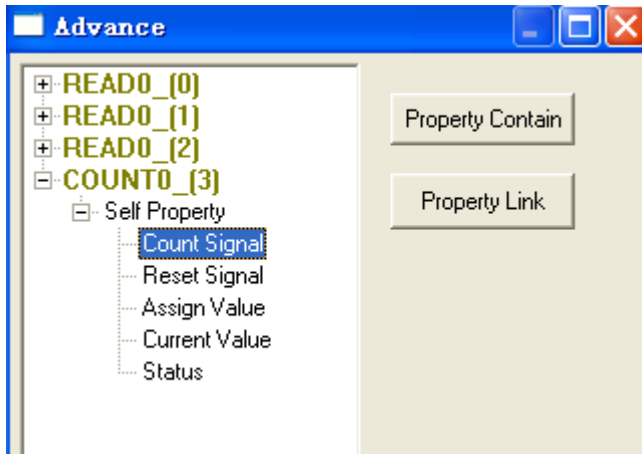

- "Count signal" property contain-PSB300 "read" component.
 "Reset signal" property contain-PSB301 "read" component.
 "Assign signal" property contain-PSW301 "read" component.

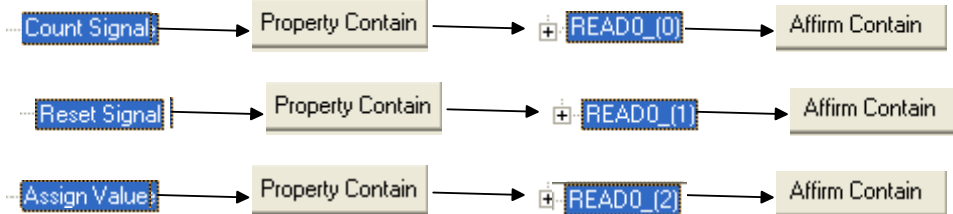

- Finally click "OK" to quit. As follows:

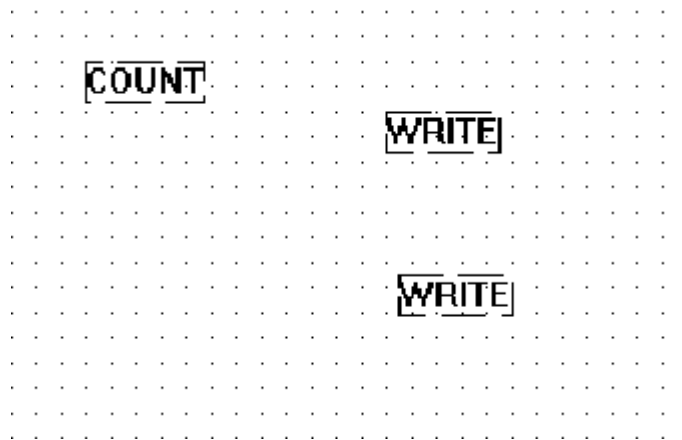

- Select the "count" component and two "Write" at the same time, Right-click the selected area, In the Pop-up dialog box ,choose "group", advanced dialog box as shown below:

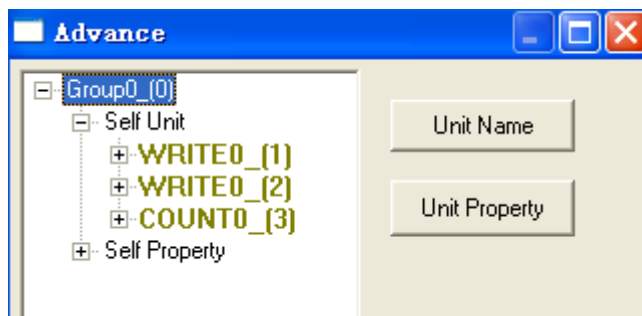

- In the Write0_ (1) self property, float the "input data" into the group.

In the "Write0_ (2)" self property, float the "input data" into the group.

In the "count0_ (3)" self property, float the "current value" and "status" into the group.

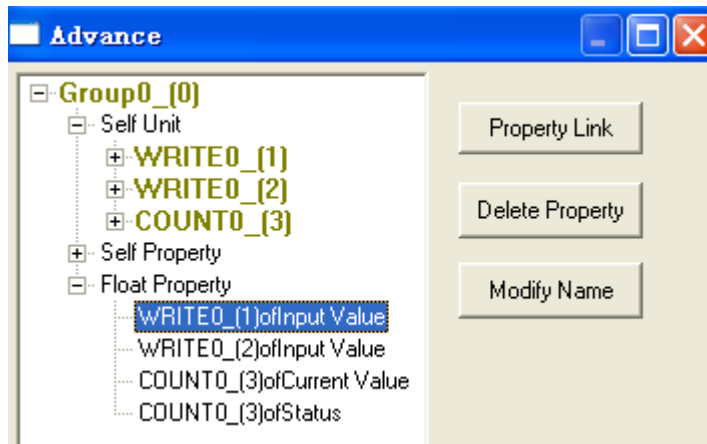

After the completion of the following diagram:

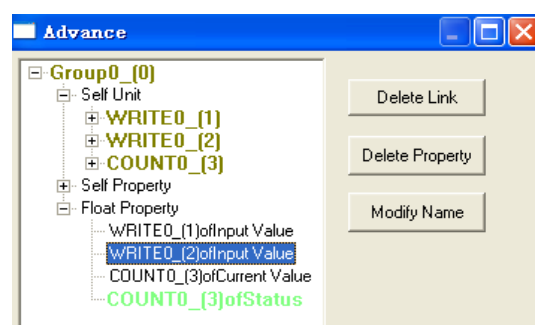
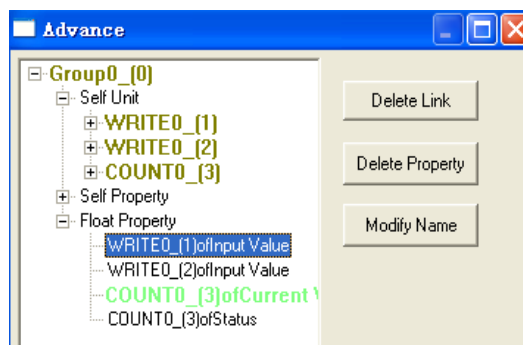

"Write0_ (1) of input data" property link "count0_ (3) of "current value"

"Write0_ (2) of input data" property link "count0_ (3) of "Status"



5. Put two "indicator button" , one digital input , one digital display , one lamp

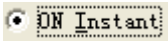

on the screen, to "indicator button", point to PSB300 and PSB3001. set button operate

mode as ; to digital input, point to PSW300, to digital display, point to PSW301.

to "lamp", point to PSB302. After the completion of the following diagram:

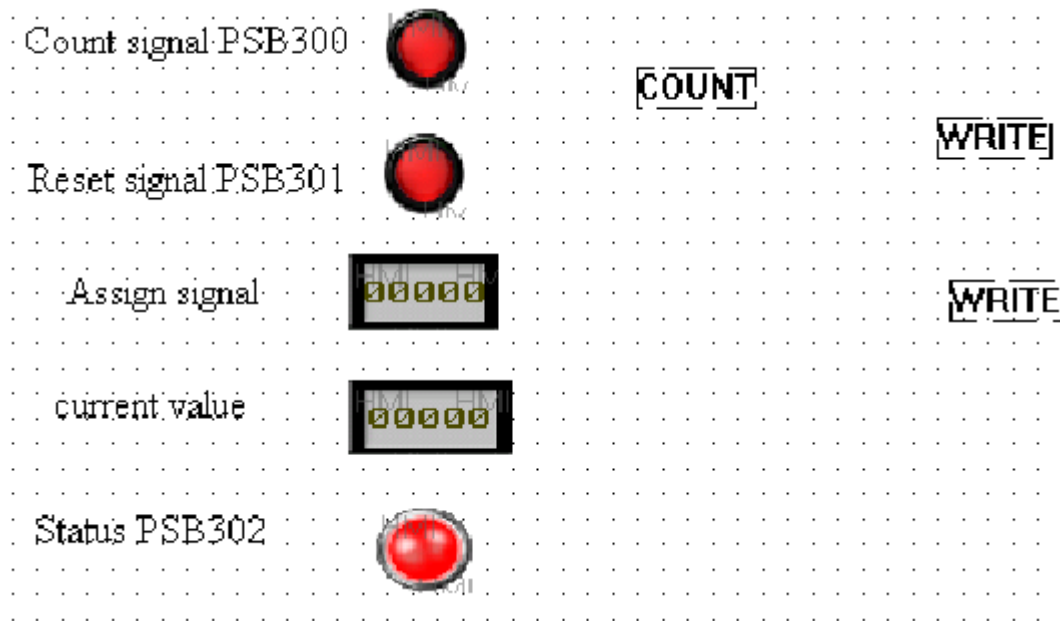

4.2.23 Pulse

- Overview:

"Periodic pulse" actually is equivalent to the counter function. the difference is: to "Periodic Pulse", When the count reaches to assign value, it will produce a transient pulse output, and conduct self-resetting; but to "counter" is turned into ON state, and need to be carried out manually reset count. Therefore, use the component to the pulse cycle, we must give it a reference frequency signal source. Timing diagram is as follows:

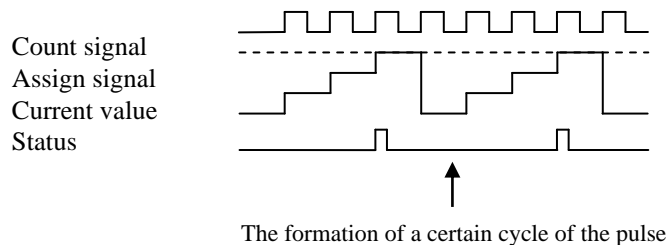

Advanced property:

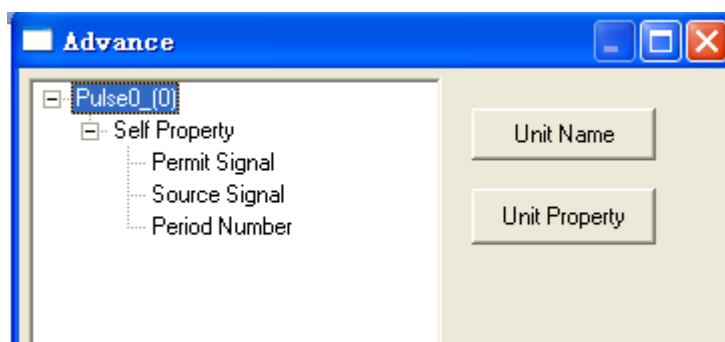

- Permit signal: Whether to allow "periodic pulse" component of work
- Source signal: As a count signal source (reference frequency signal source)

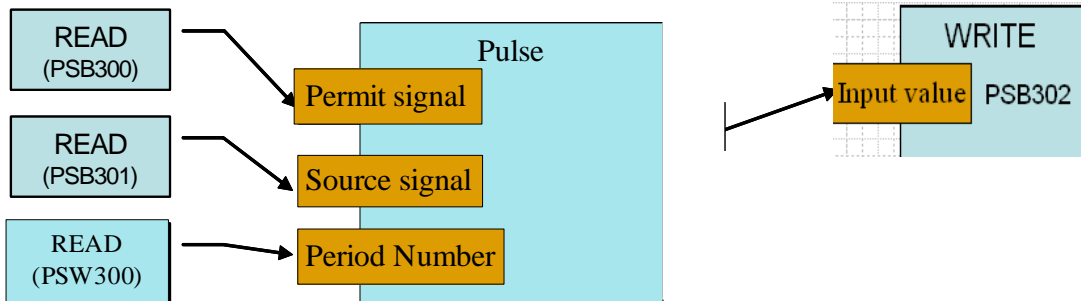

●Period Number: Count set value (the value generated by the decision of the pulse and reference signal cycles multiple relationships)

Example: Set PSB300 as Permit signal, set PSB301 as Source signal and PSW301 as Period Number, PSB302 as Periodic pulse of the output bit.



Composition diagram

Step1: Building a screen, placing parts

1. Building a new screen, placing the following components on the screen: three “read” , one “write” , one “pulse” , as follows:

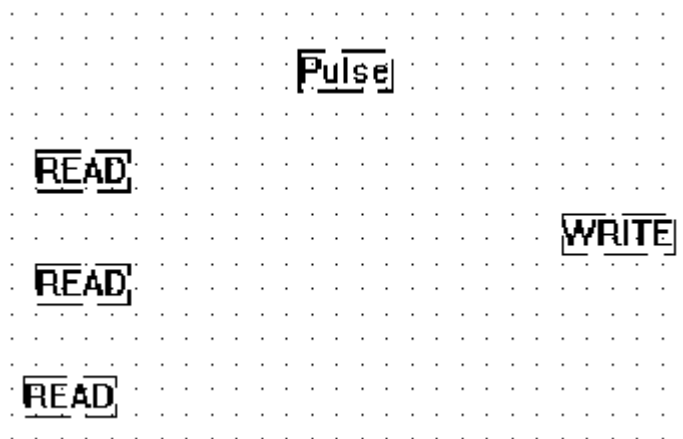

2. As the following set: 3 "read" components point separately to PSB300, PSB301, PSW300. to "write" element, point to PSB302.

Step2: Advanced Operations

1. Select the three “read” and “pulse” component at the same time, Right-click the selected area, In the Pop-up dialog box, choose Advanced, advanced dialog box as shown below:

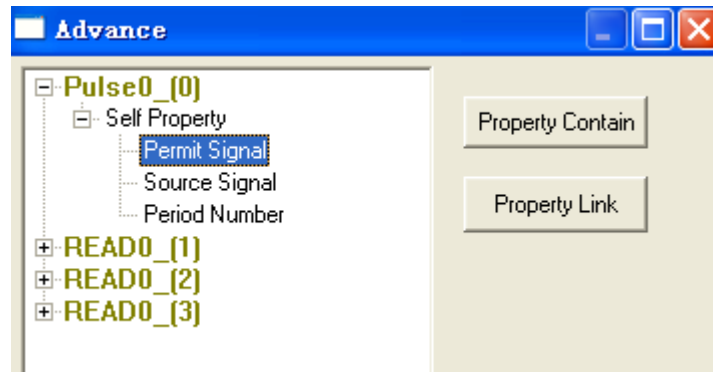

2. " Permit signal" property contain-PSB300 "read" component.

"Source signal "property contain-PSB301 "read" component.

"Period Number "property contain-PSW300 "read" component.

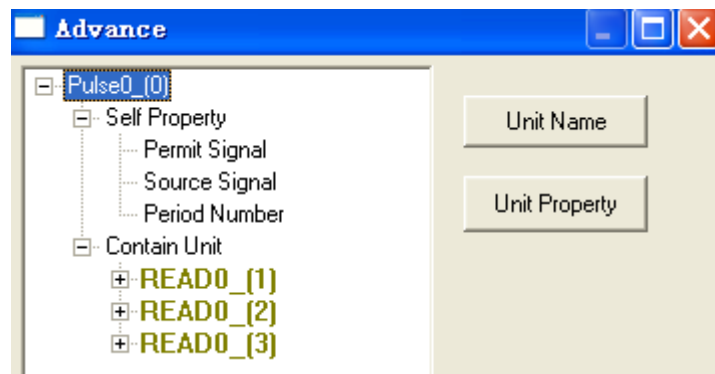
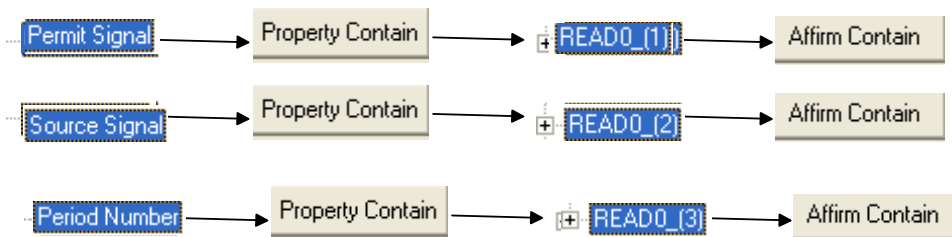

5. Finally click "OK" to quit. As follows:

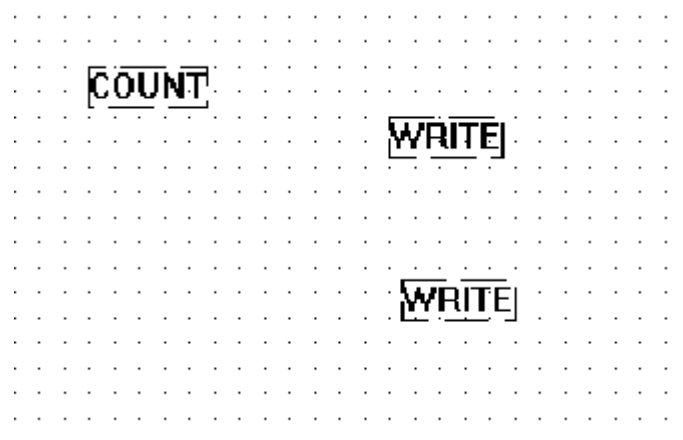



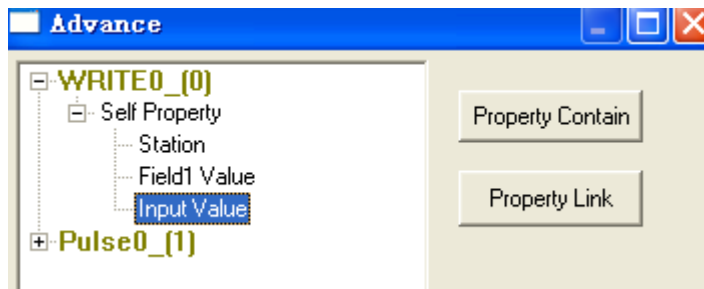

6. Select "pulse" component and "Write" at the same time, Right-click the selected area, In the Pop-up dialog box ,choose "advanced", advanced dialog box as shown below:

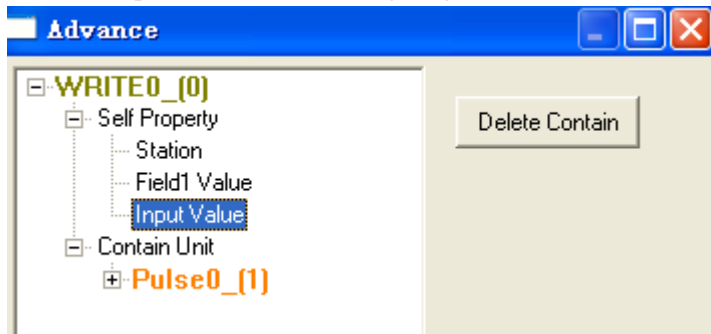

"input value" of "Write0_ (0)" self property , property contain "pulse"

After the completion of the following diagram:

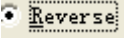
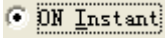

7..Put two "indicator button" , one digital input , one lamp  on the screen, to one "indicator button" , point to PSB300, set button operate mode as , to the other "indicator button" , point to PSB301, set button operate mode as ; to "lamp", point to PSB302. After the completion of the following diagram:

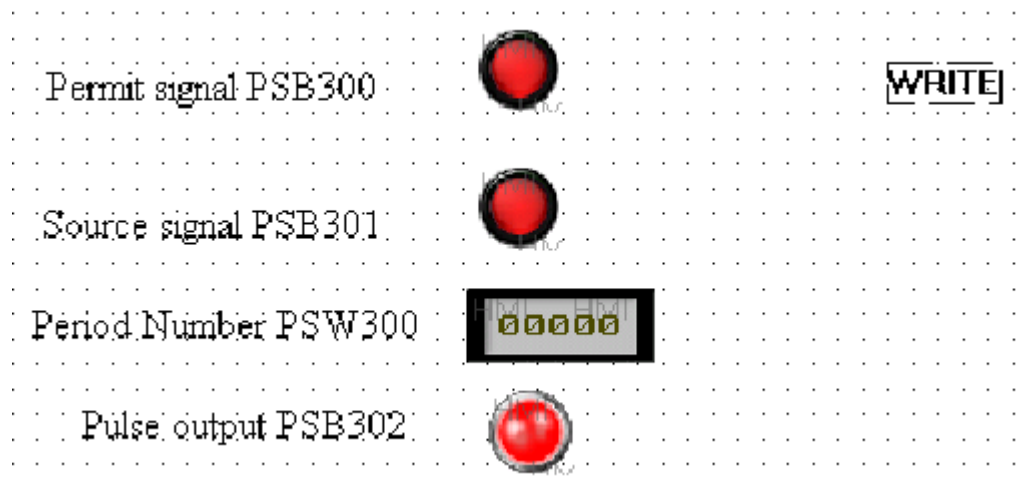

4.2.24 LED LIGHT

"LED LIGHT" component is the OP560 series of touch-screen settings, it can control 16 button keypad light/ OFF on the panel according to the value of register (word) . Each light corresponds to bit of the register (word) , bit to ON, the corresponding lamp light ,The distribution

of light and the position is as follows:

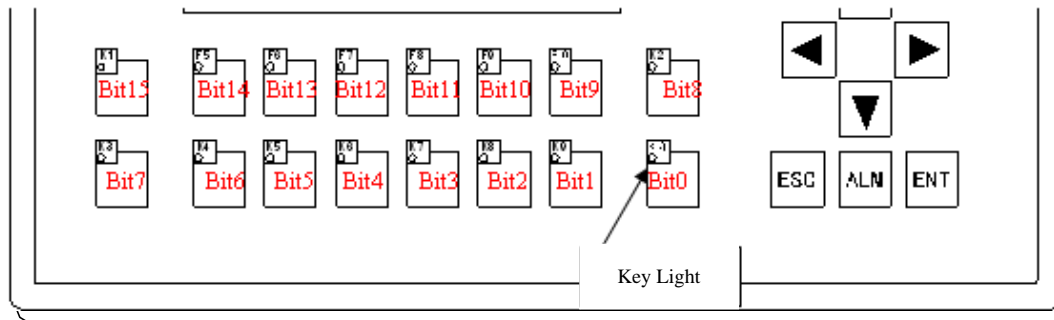

Note: This involves the decimal or 16 hex numbers to binary number conversion.

To decimal as examples:

Dec	Hex	- Light status (only listed bright lights)
5	101	Bit2, Bit0
18	10010	Bit1, Bit4

Analogy:

Advanced property:

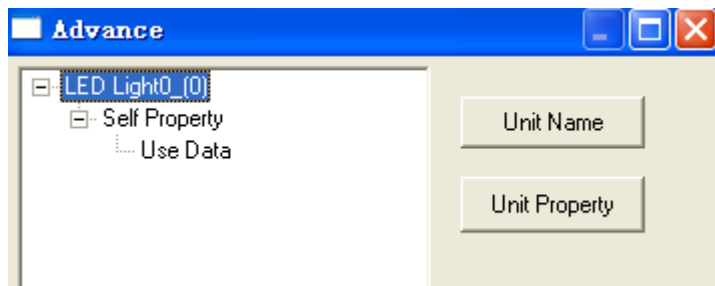

Use Data: Setting control data of source

● **Routine**

Use PSW300 as a source of control data, using a decimal number to control the button light.

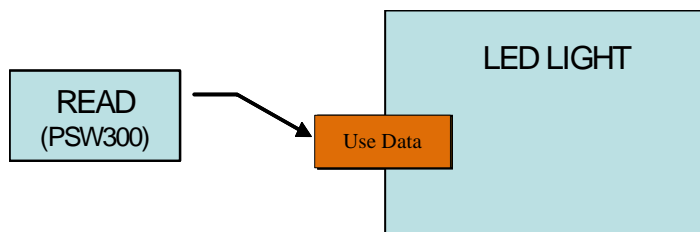

Composition diagram

1. Building a new screen, placing the following components on the screen: one “LED LIGHT”

one “read” ,. To read , point to PSW300.

2.Box selecting them, Right-click the selected area, In the Pop-up dialog box ,choose Advanced, advanced dialog box as shown below:

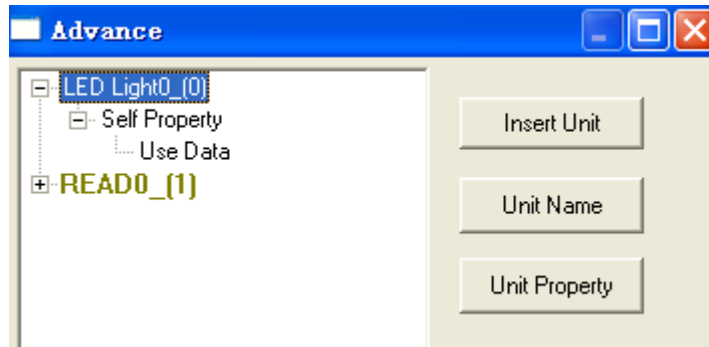

“Use Data” property contain “read”

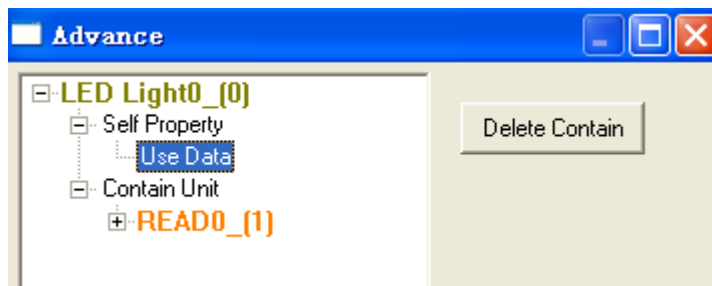

3. Double click “LED LIGHT” to open the property dialog box, Add two data in the left blank area, as shown below:



4. Put one “digital input” on the screen , point object to PSW300, After the completion of the following diagram:

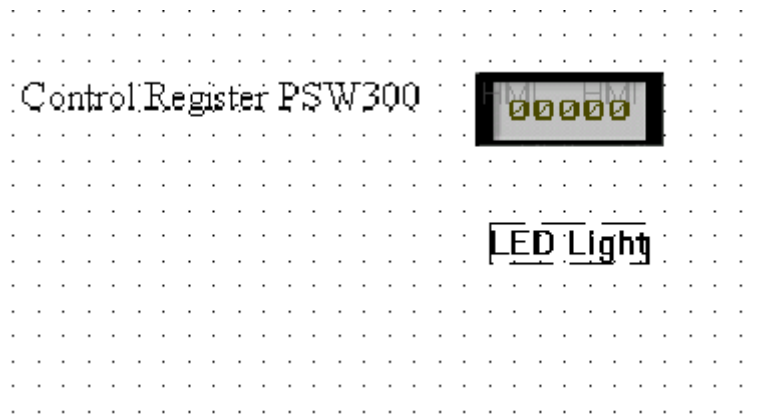

4.2.25 Print

• **Overview:** "Print" component is used to designate a print area on the screen, when the device is triggered all the contents of the regions will be print out(the premise is correct connected to the printer).

Advanced property:

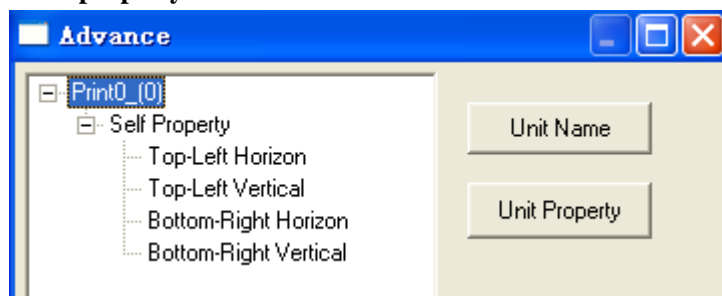

Top-left Horizon : Top-left Horizon of print area
Other attributes, and so on, will not do tired out.

• **Routine**

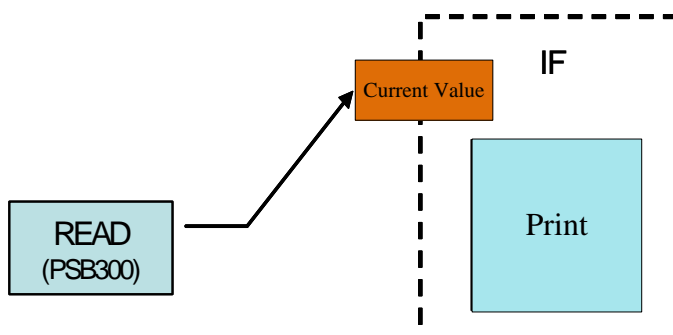

Use PSB300 as a print trigger bit, print the contents of screen region.

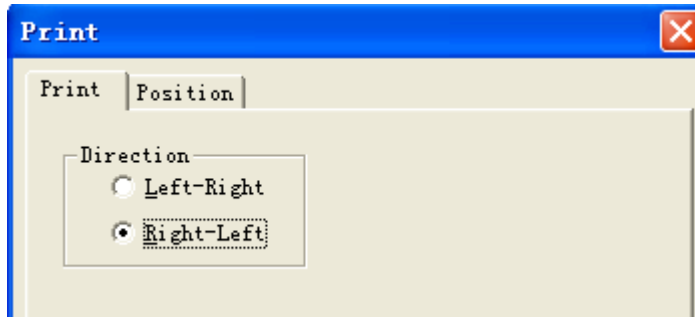

1. Place a "Print" component, manually pull into a rectangular area, double-click bring up the Properties dialog box.



Note: Set Print Direction to Right-Left, or the print results would be wrong.

2. Place one “IF” component , one “read”  on the screen, to “read”, point object to PSB300, as follows:

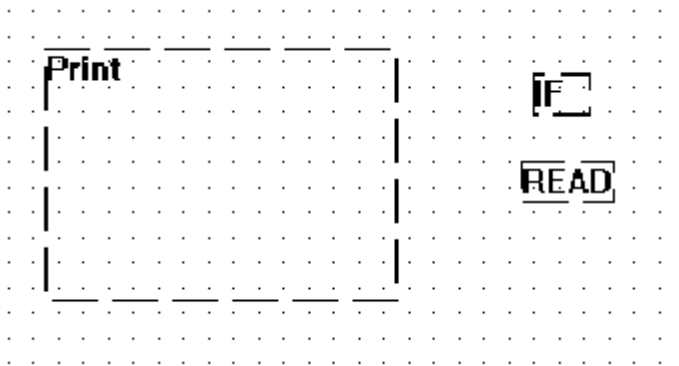

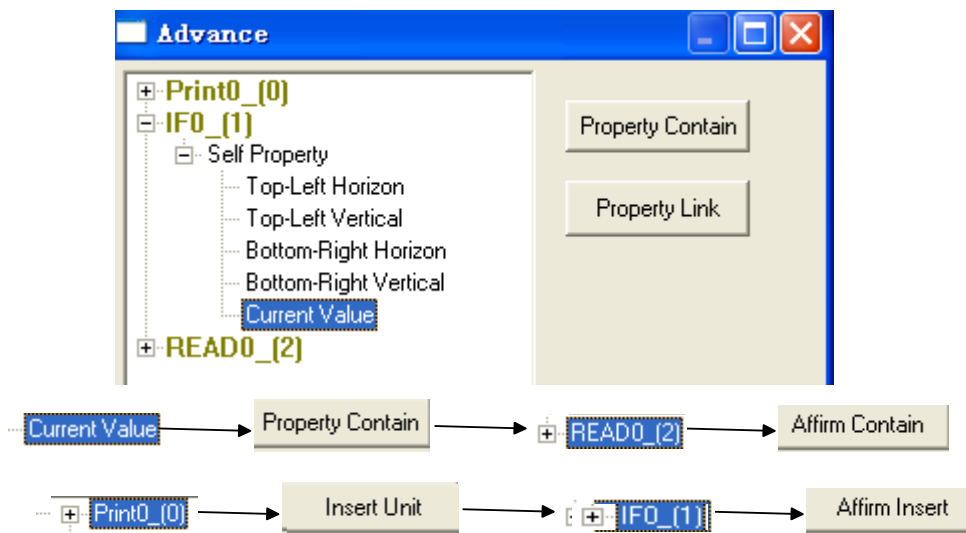

3. Select “IF”, “read” and “print” at the same time, Right-click the selected area, Pop-up the following dialog box :

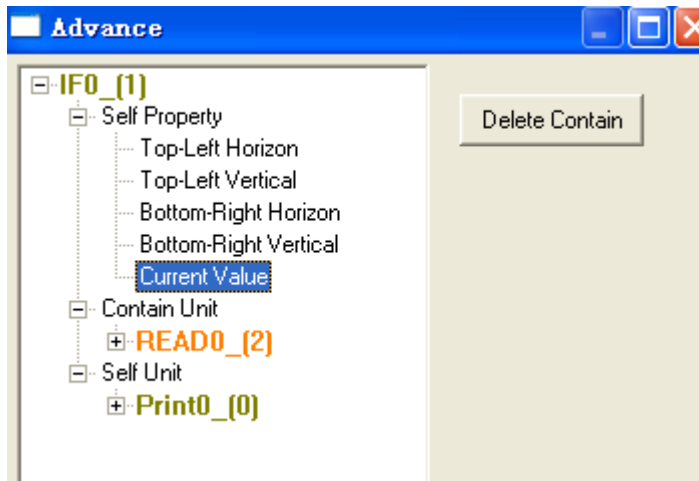

As shown below:



4. Place one “button”  on the screen, point object to PSB300, set button operate as

. In the print area, you can place any parts or graphic. After the completion of the following diagram:

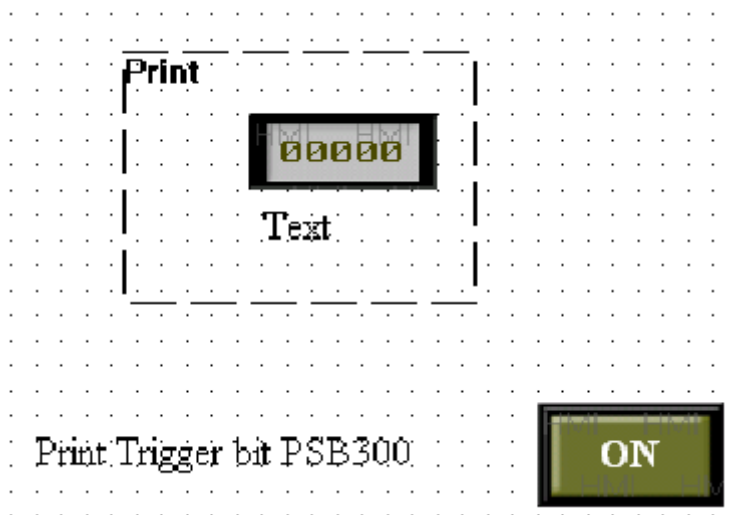

Description: Mini printer can only print black / white 2-color, if there are color graphics in the printing area, they will be color distortion.

4.2.26 Sin

- **Overview:**

This section we will introduce the sin trigonometric function, trigonometric function is mainly used in numerical computing, many users use instructions of PLC programming tool to achieve the trigonometric functions Numeric Conversion. Sin instructions can also achieve numerical triangle Conversion through the use of write, read advanced instructions . The following will describe the properties and function use of sin instruction.

Property Description

- **Property Description:**



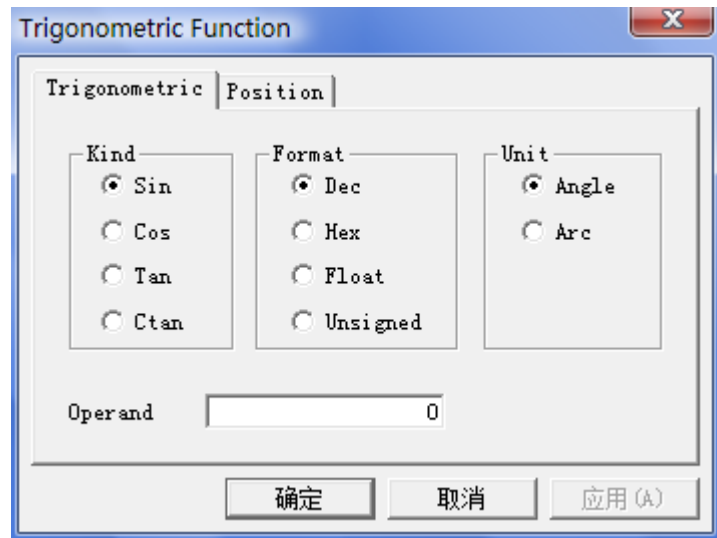



Click the software icon  , put sin trigonometric function on the screen, double-click it to open property dialog box, as follows:



Property Name	explain
Kind	We can select sin ,cos, tan ,ctan depending on which kind of Numeric Conversion we want.
Format	There are four types of date like Dec, Hex, Float and unsigned in Numeric Conversion.
Unit	Angle or Arc participate in operation depending on which type users choose .
Operand	Input the data needed to Numeric Conversion ,users can input it indirectly by registers each time, also can enter the conversion data again.

● **Routine:**

Step1: Build screen , place parts on the screen :

Build a new project, put the following parts on the screen: two text , one digital display , one digital input , one , one read , one write , as follows:

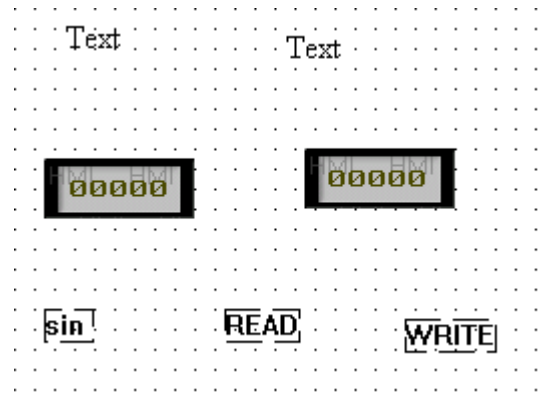

Step2: Modify properties

1. Modify the basic component properties

a. Double-click the left text, open the Properties dialog box, In the text editing area, enter the following text:



b. Double-click the right text, open the Properties dialog box, In the text editing area, enter the following text:

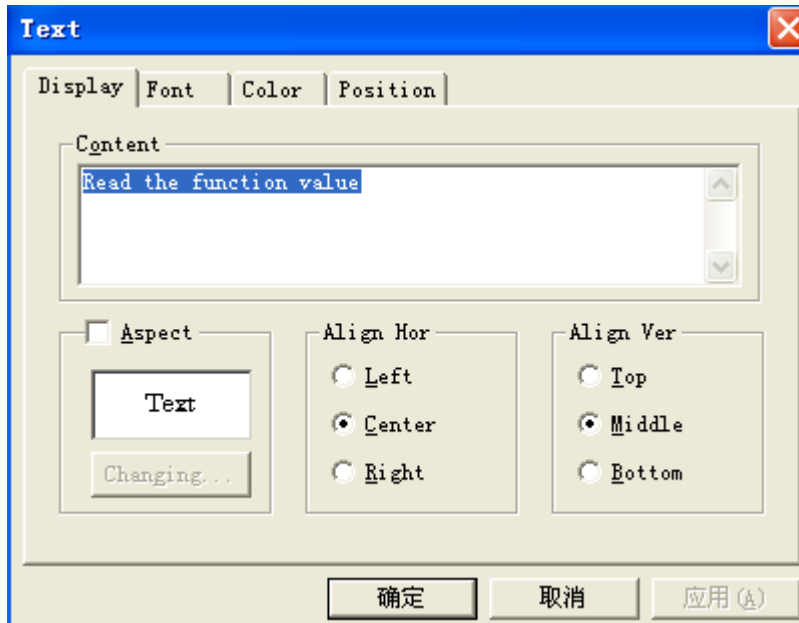

c. Double-click the left “digital input”, open the Properties dialog box, in **Object** option , modify object to PSW300, as follows:

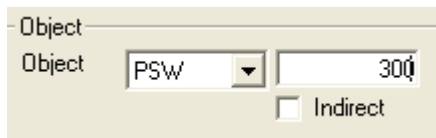

d. Double-click the right “digital display”, open the Properties dialog box, in **Object** option , modify object to PSW302, set **Data Type** as **DWord** , as follows:

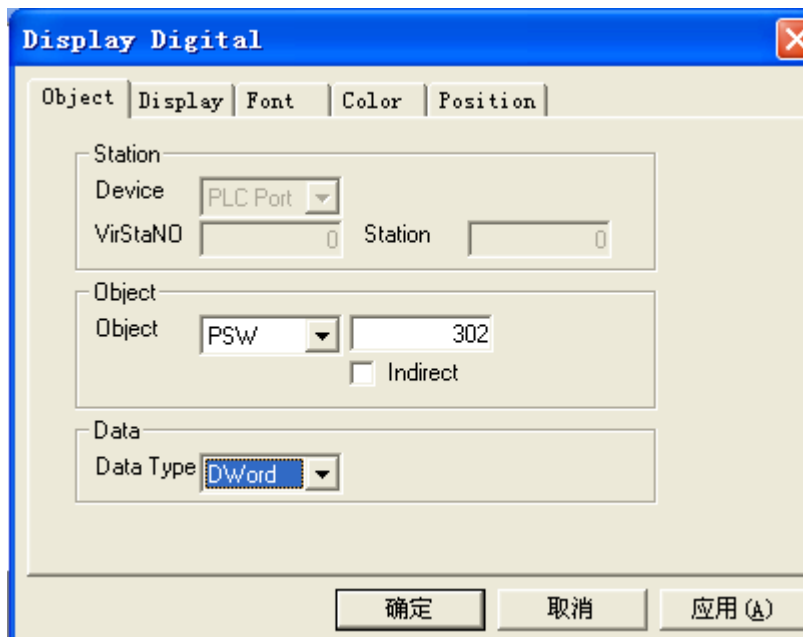

e. In the display option, set **Format** as **Float** , in the **Bit Length** , set **Total** , **Float** , as the following setting:

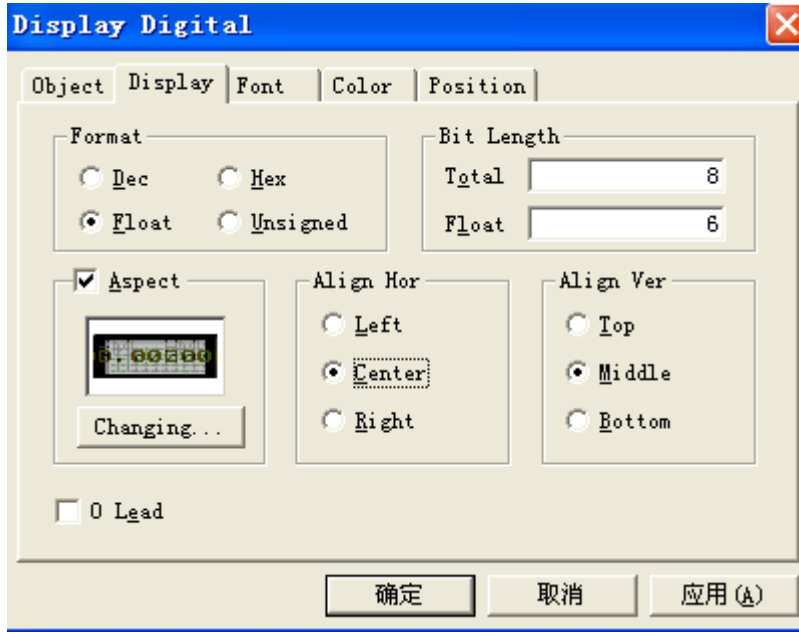

2. Property modification of advanced command.

- a. Double-click `sin`, open the Properties dialog box, set `Kind` as `Sin`, set `Format` as `Float`, as the following setting:

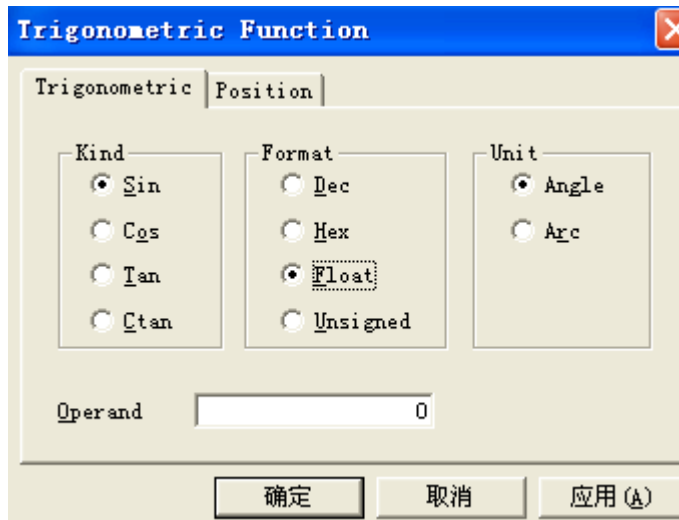

- b. Double-click the "Read", open the Properties dialog box, modify `Object` to PSW300, as follows:

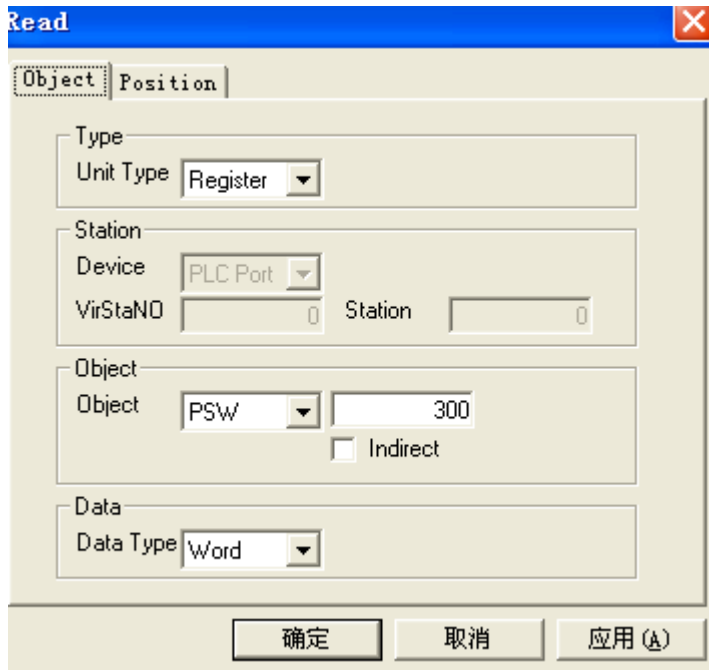

c. Double-click “Write”, open the Properties dialog box , modify **Object** to PSW302, set data

Type as **DWord**, as follows:

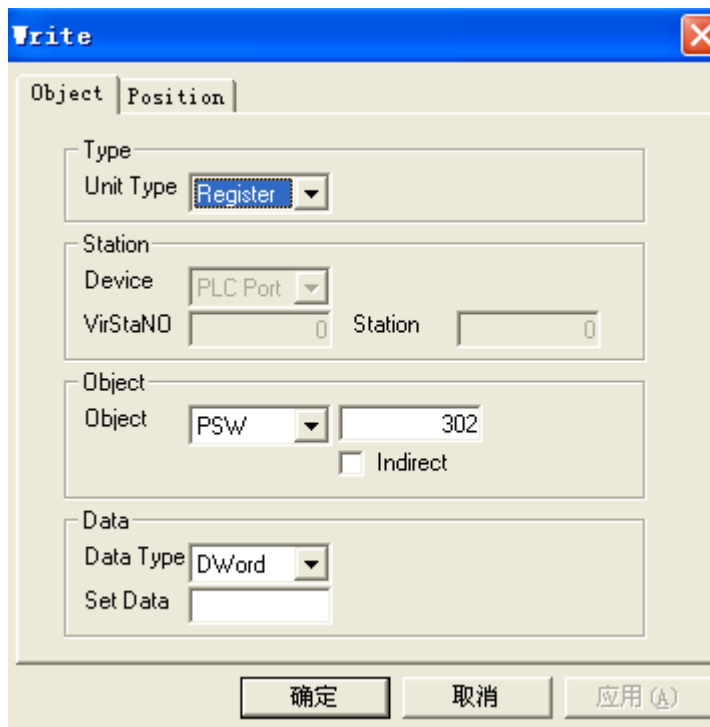

d. Property set belonging to these parts are completed, the final results are as follows:

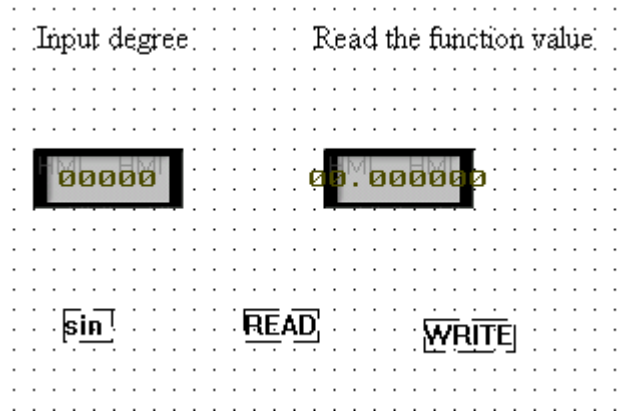

Step3: Advanced Operations

1. Select sin、 Read、 Write at the same time, Right-click the selected area, choose Advanced ,as follows:

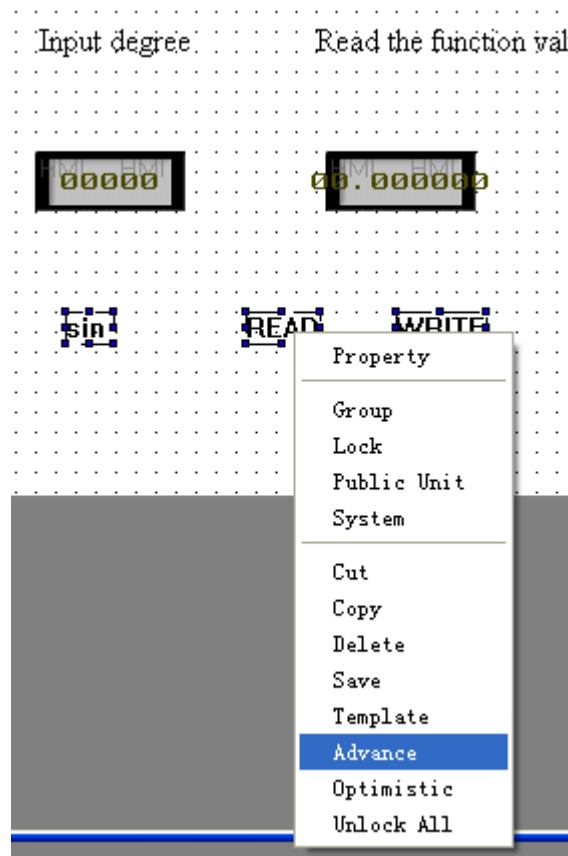

2. Pop-up the following advanced dialog box:

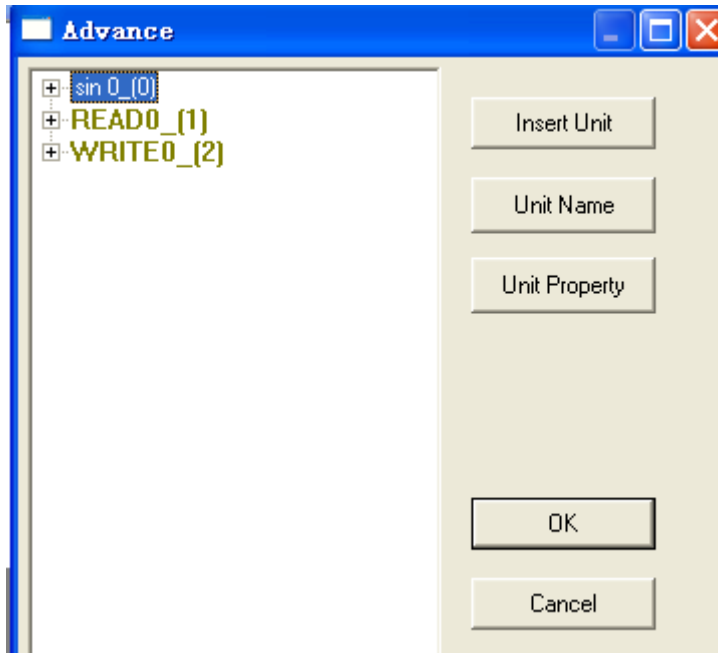

3. Click the small plus sign  in front of directive **WRITE0_ (2)** , in the self property , select **Input Value** , as follows:

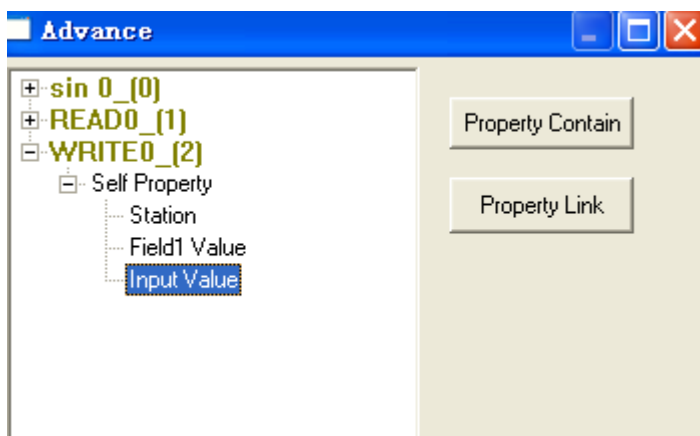

4. “Input value ” property contain **sin 0_ (0)** , as the following step:

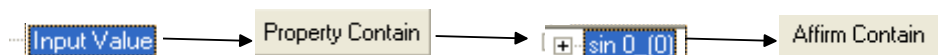

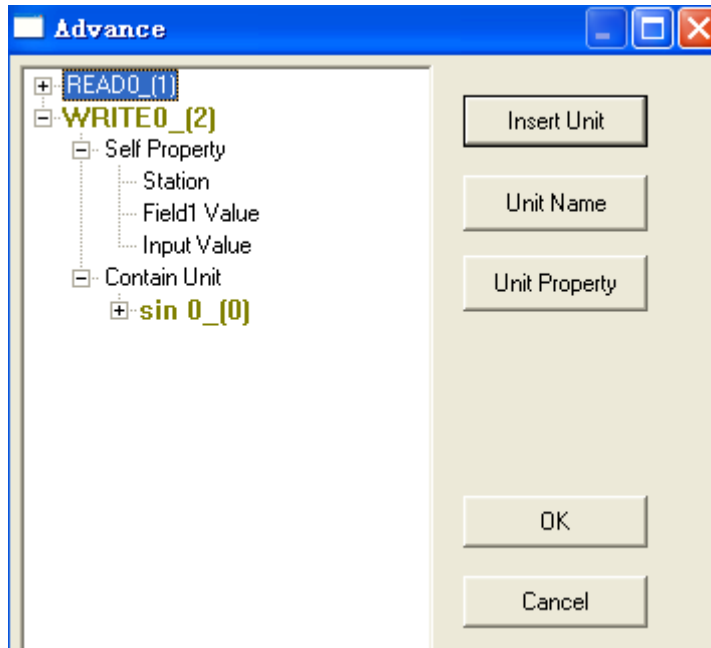

5. Open the self property of **sin 0_0** , select operand to property contain **READ0_1** , the steps are shown below:

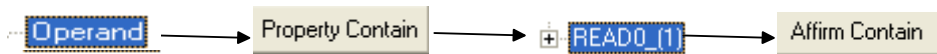
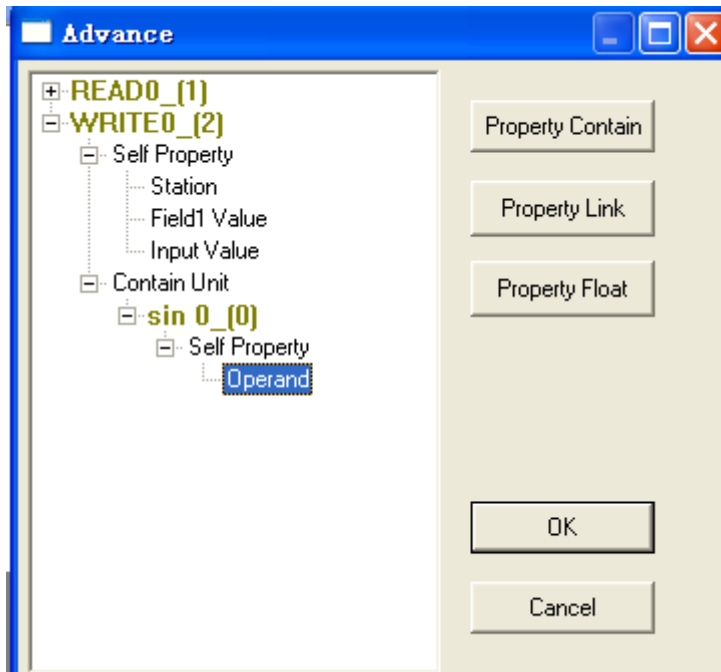

The effects dialog box:

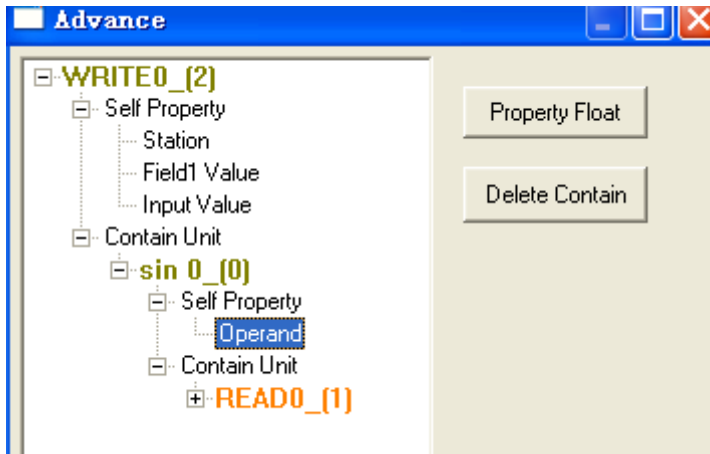

6. At this point, all operations have been completed; the final picture is as follows

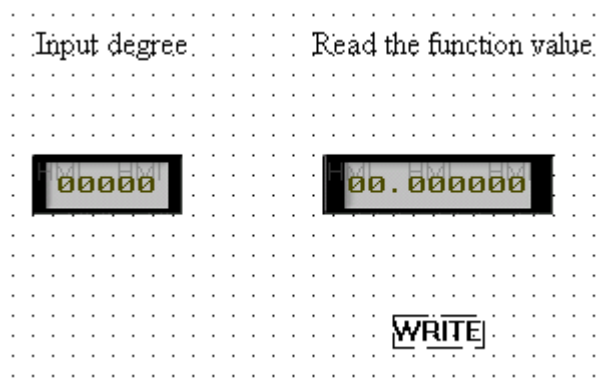

7. Click the “off –line simulation”  icon on the software, See the following simulation results:

① Input data in the digital input box :

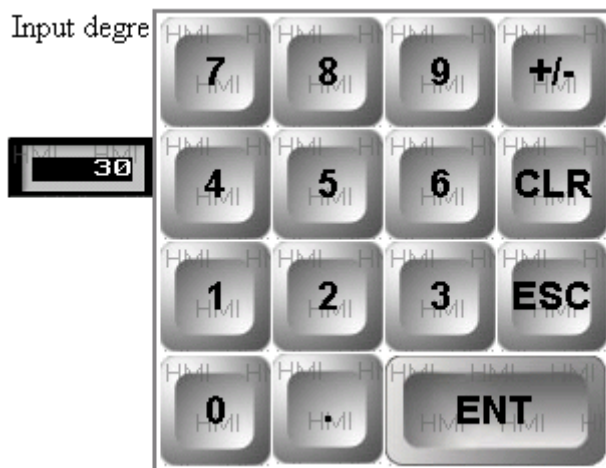

② the input data converted into the corresponding sin values.

Input degree

Read the function value



Note: (1) in the digital input box, input data must be positive, if the input value is negative, the converted sin value will be wrong.

(2) Read function value must be float , otherwise , The value obtained is not very accurate.

4.2.27 Arcsin

• Overview:

This section will introduce the arcsin anti trigonometric function, like sin trigonometric function, mainly used in the numerical computation, the only difference is that arcsin anti trigonometric function is the inverse process of sin trigonometric function. value is converted to angle or Radian. The following will describes arcsin directive's properties and functions use.

• Property Description:







Click the software icon  , put arcsin anti trigonometric function on the screen, double-click it to open property dialog box, as follows:



Property Name	explain
Kind	We can select sin ,cos, tan ,ctan depending on which kind of Numeric Conversion we want.
Return Units	Function value return value, which can be angle or radian.
Operand	Input the data needed to Numeric Conversion,users can input it indirectly by registers each time, also can enter the conversion data again.

●Routine:

Step1: Build screen , place parts

Build a new project, put the following parts on the screen: two text , one digital display , one digital input , one \sin , one read , one write , as follows:

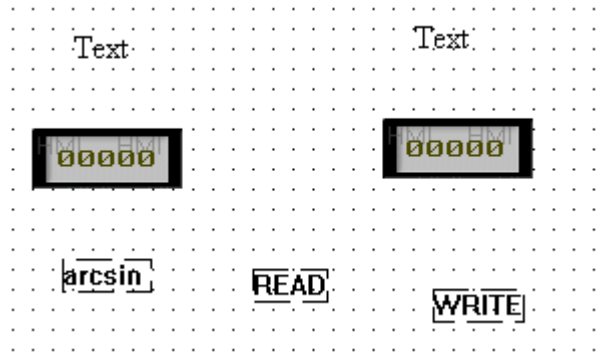

Step2: Modify properties

1. Modify the basic component properties

a. Double-click the left text, open the Properties dialog box, In the text editing area, enter the following text:



b. Double-click the right text, open the Properties dialog box, In the text editing area, enter the following text:

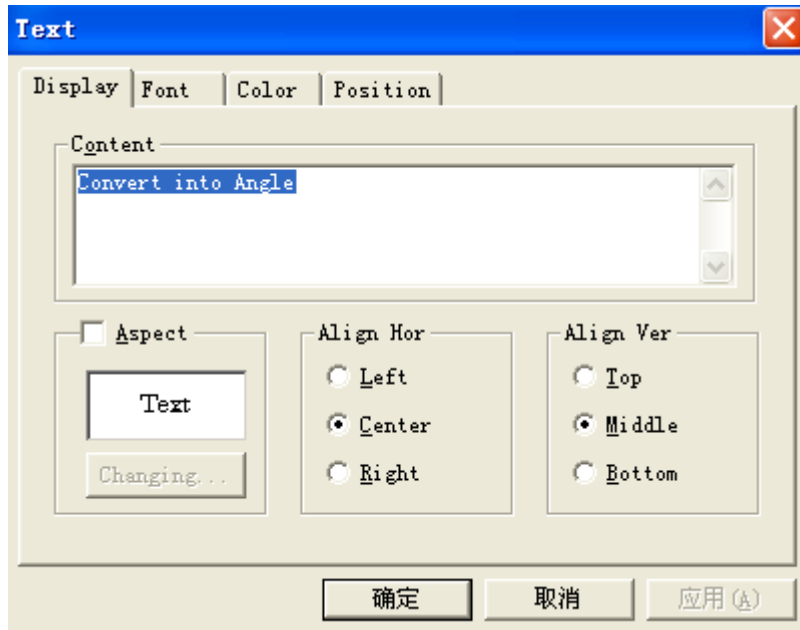

c. Double-click the left “digital input”, open the Properties dialog box, in **Object** option , modify object to PSW300, set **Data Type** as **DWord** as follows:

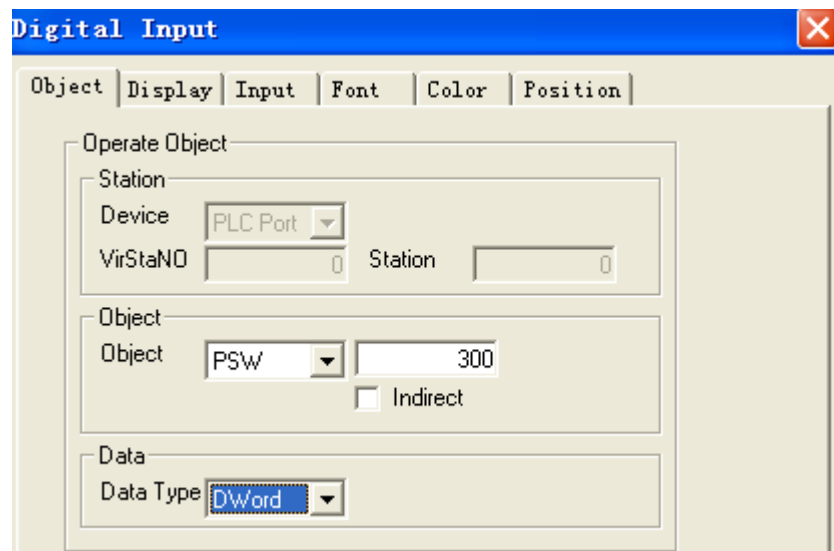

d. In the display option, set **Format** as **Float** , in the **Bit Length** , set, **Float** , as the following setting:

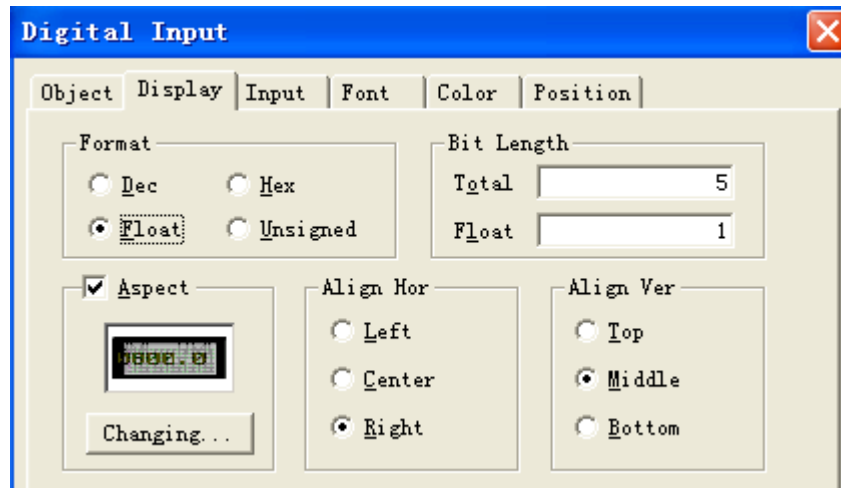

e. Double-click the right “digital display”, open the Properties dialog box, in **Object** option , modify object to PSW302, as follows:

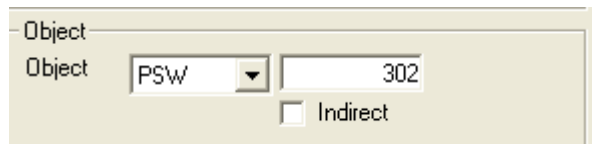

f. In the display option, set **Format** as **Dec** , as follows:

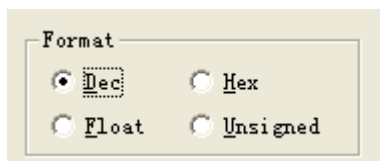

2. Property modification of advanced command.

a. Double-click arcsin, open the Properties dialog box, set **Kind** as **arcsin** , set **Return Units** as **Angle** , as the following setting:



b. Double-click the “Read”, open the Properties dialog box , modify **Object** to PSW300, set data

Type as **DWord** , as follows:



c. Double-click “Write”, open the Properties dialog box , modify **Object** to PSW302, as follows:

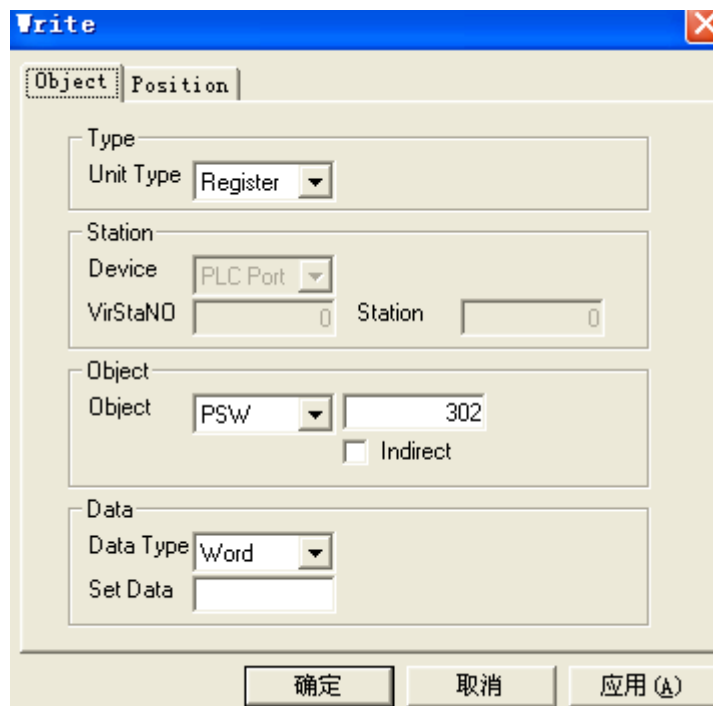

d. Property set belonging to these parts are completed, the final results are as follows:

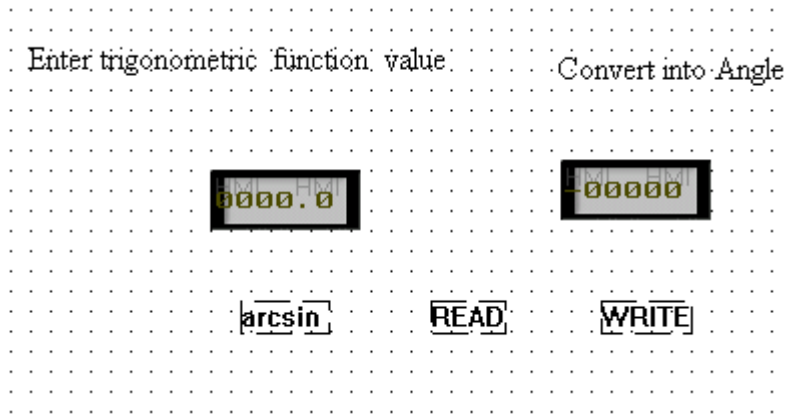

Step3: Advanced Operations

1. Select arcsin, Read, Write at the same time, Right-click the selected area, choose Advanced, as follows:

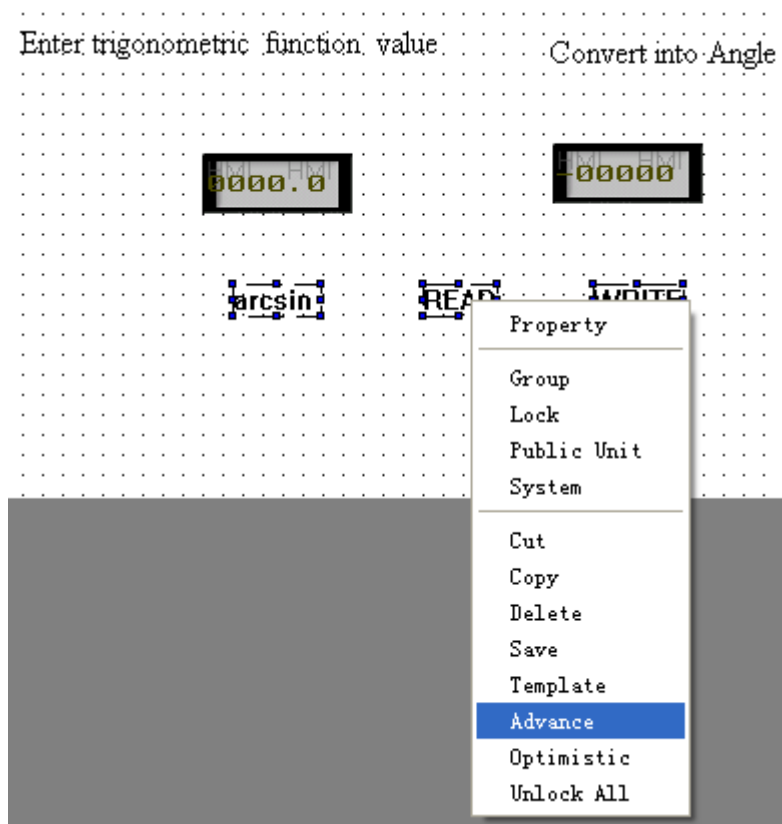

2. Pop-up the following advanced dialog box:

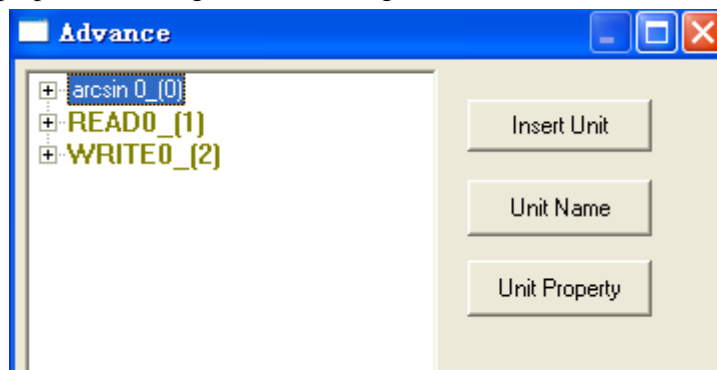

3. Click the small plus sign  in front of **WRITE0_2** , in the self property , select **Input Value** , as follows:

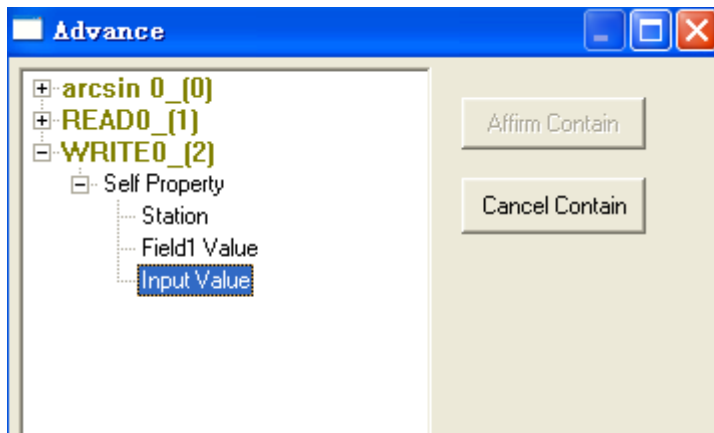

4. “Input value ” property contain  **arcsin 0_0** , as the following step:

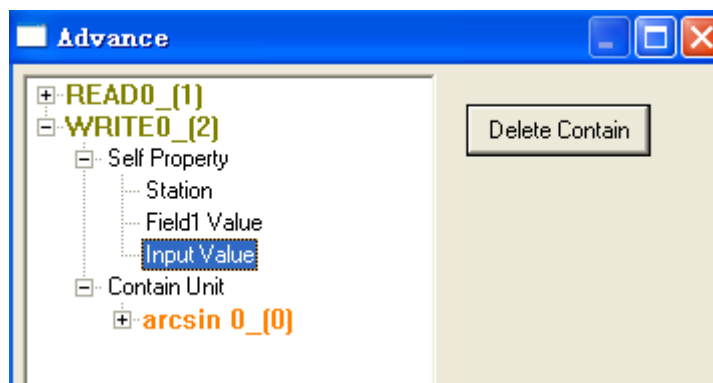
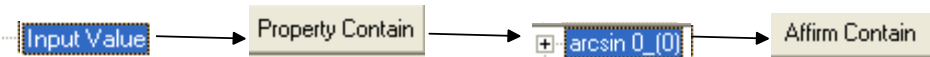

5. Open the self property of  **arcsin 0_0** , select “operand” to property contain **READ0_1** , the steps are shown below:

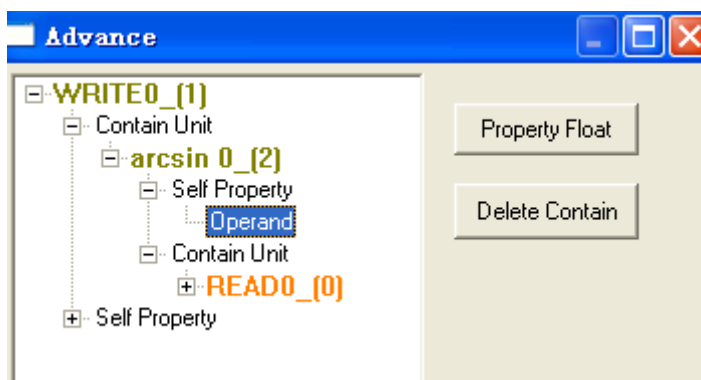
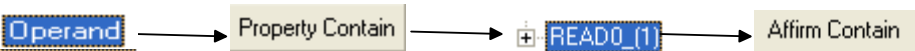

6. At this point, all operations have been completed; the final picture is as follows:

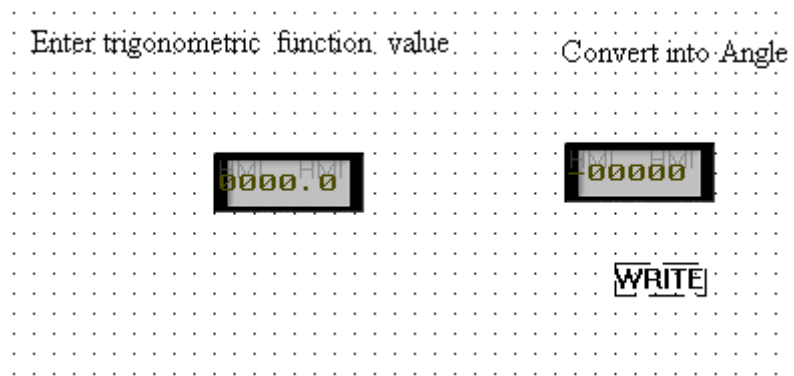

7. Click the “off –line simulation ”  icon on the software, See the following simulation results:

① Input data in the digital input box :

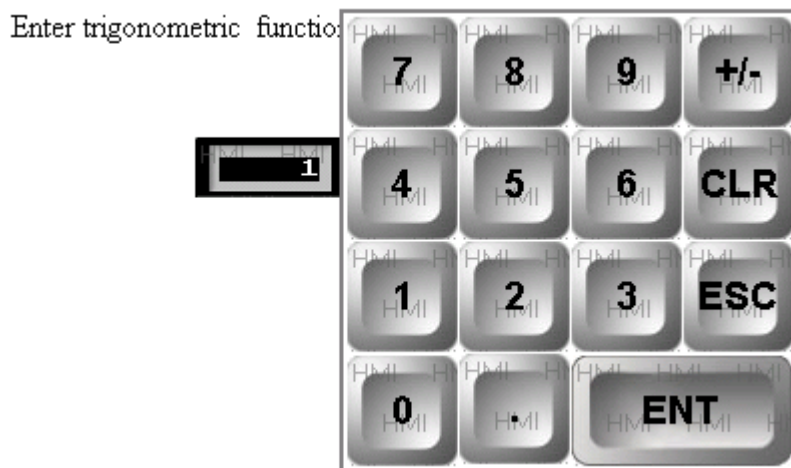

② the input data converted into the corresponding angle and Radia.

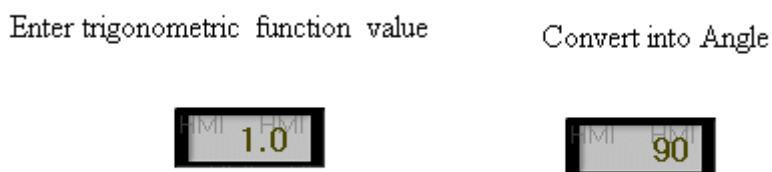

Note: 1) input data must be float , and decimal places can not be too much, otherwise the contained angle or Radia.will not very accurate.

4.2.28 Power

• Overview:

This section will introduce “pow” function, familiar with sin trigonometric function, arcsin anti trigonometric functions, mainly used in the numerical computation, users who not familiar with Advanced directives, typically using “set data” button, function button or a function filed to achieve it, but the production process is more complex, and not very flexible. The following will describes Pow directive’s properties and functions use.

•Property Description:

“Pow” definition is that specified data will be multiplied by several times, similar to involution , but the mathematics is different from the power function, In mathematics where a function is just part of one of them.

Click the software icon  , put Pow on the screen, double-click it to open property dialog box, as follows:

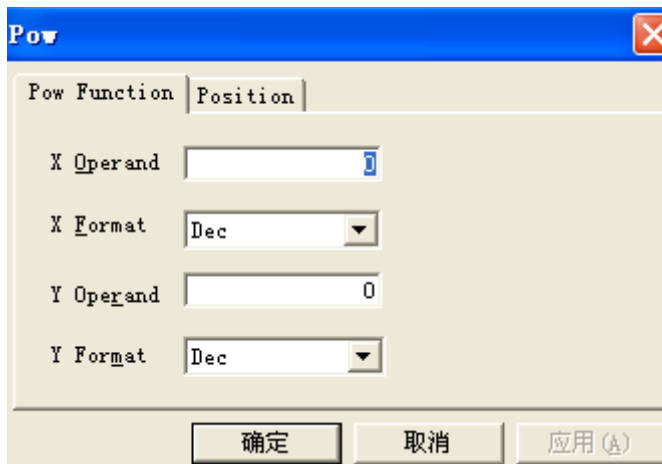





Property Name	explain
X operand	Implementation of the operation data, similar to the mathematical power function in the base.
X Format	Data Type :Dec、 Hex、 Float、 Unsigned
Y operand	Operands implementation of several actions to develop, similar to the mathematical power function in the index
Y Format	Data Type :Dec、 Hex、 Float、 Unsigned

•Routine

Step1: build screen , place parts:

Build a new project, put the following parts on the screen: three text , one digital display

, two digital input , one , two read , one write , as follows:

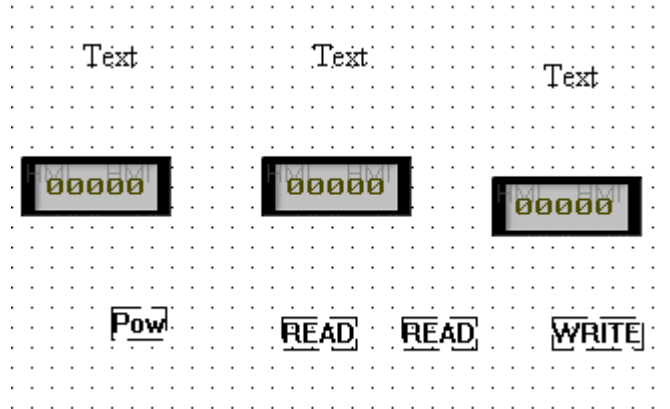

Step2: Modify properties

1. Modify the basic component properties

a. Double-click the left text, open the Properties dialog box, In the text editing area, enter the following text:



b. Double-click the middle text, open the Properties dialog box, In the text editing area, enter the following text:



c. Double-click the right text, open the Properties dialog box, In the text editing area, enter the following text:



d. Double-click the left “digital input”, open the Properties dialog box, in **Object** option, modify object to PSW300, as follows:

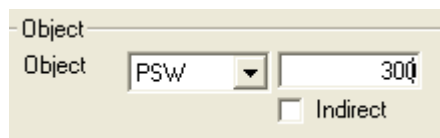

e. Double-click the middle “digital input”, open the Properties dialog box, in **Object** option, modify object to PSW301, as follows:

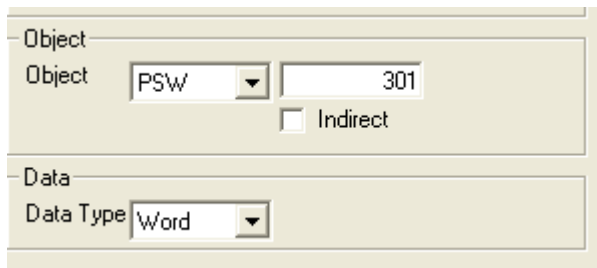

f. Double-click the right “digital display”, open the Properties dialog box, in **Object** option , modify object to PSW302 , as follows:

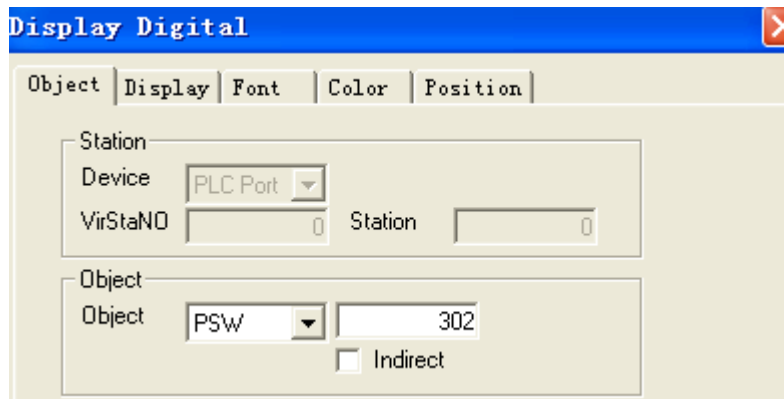

2. Property modification of advanced command.

a. Double-click the left “Read”, open the Properties dialog box, modify **Object** to PSW300, as follows:



b. Double-click the right “Read”, open the Properties dialog box, modify **Object** to PSW301, as follows:



c. Double-click “Write”, open the Properties dialog box , modify **Object** to PSW302, as follows:

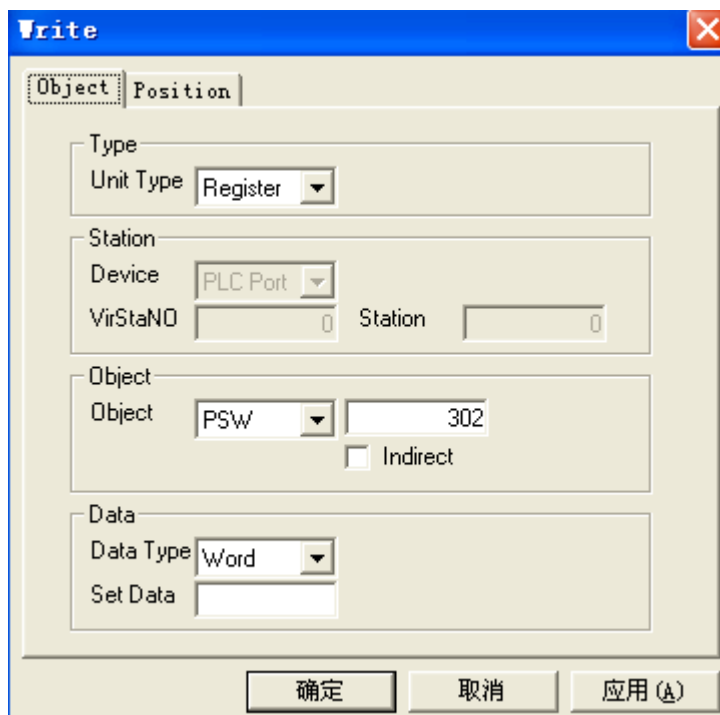

d. Property belonging to this part is completed; the final result is as follows:

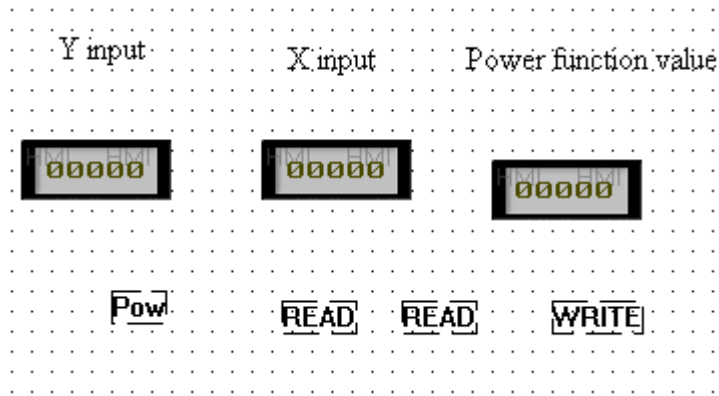

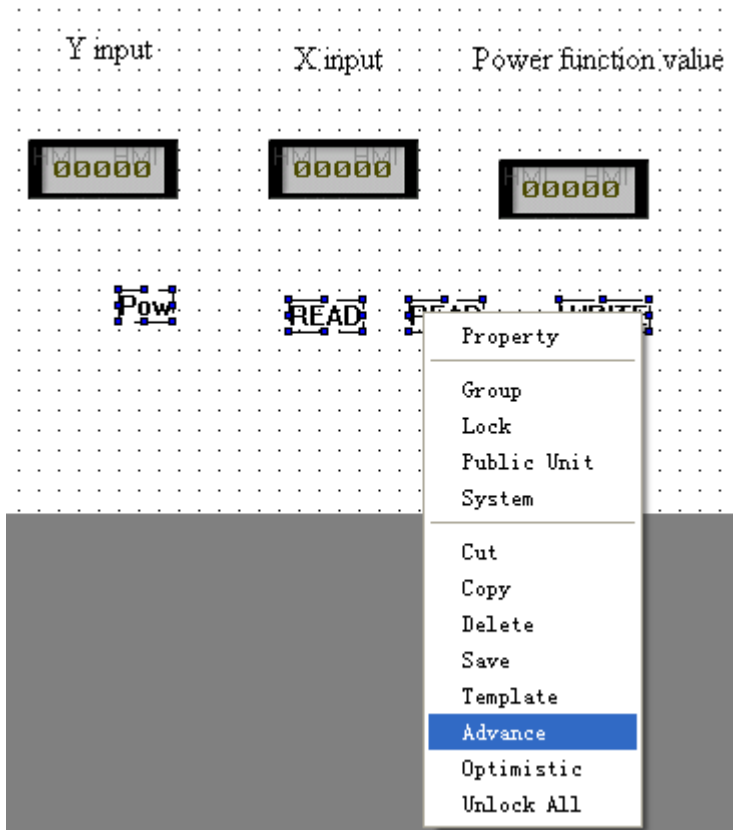

Step3: Advanced Operations

1. Select Pow, two Read, Write at the same time, Right-click the selected area, choose Advanced, as follows:

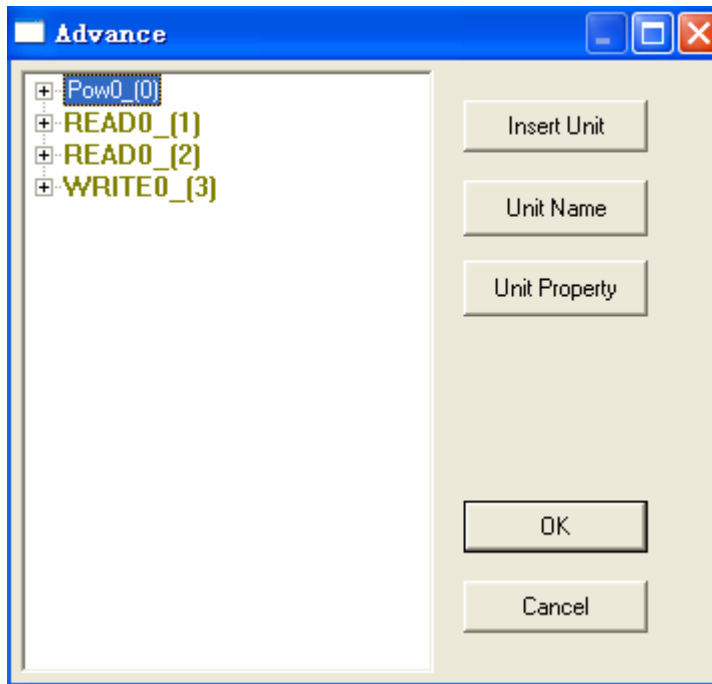

2. Pop-up the following advanced dialog box:



3. Click the small plus sign  in front of directive **WRITE0_(3)**, in the self property, select **Input Value**, as follows:

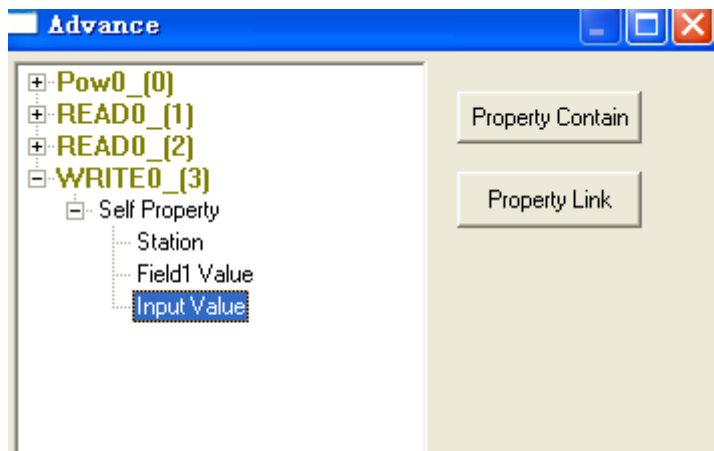

4. “Input value” property contain  **Pow0_(0)**, as the following step:

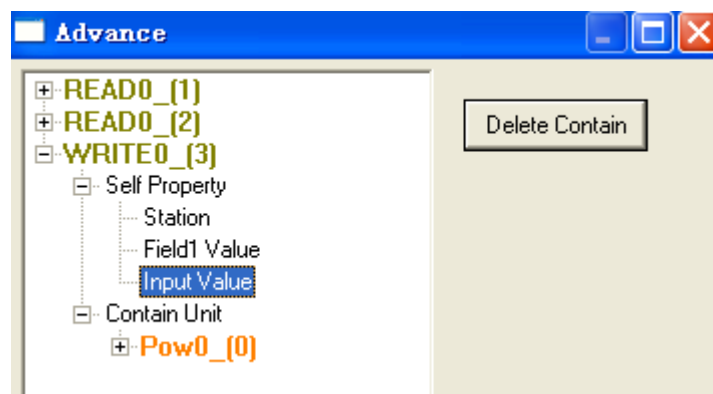
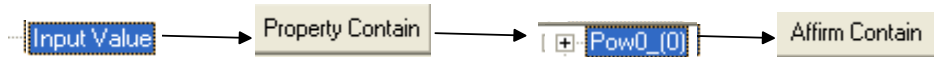

5. Open the self property of **Pow0_0**, select “X” to property contain **READ0_1**, the steps are shown below:

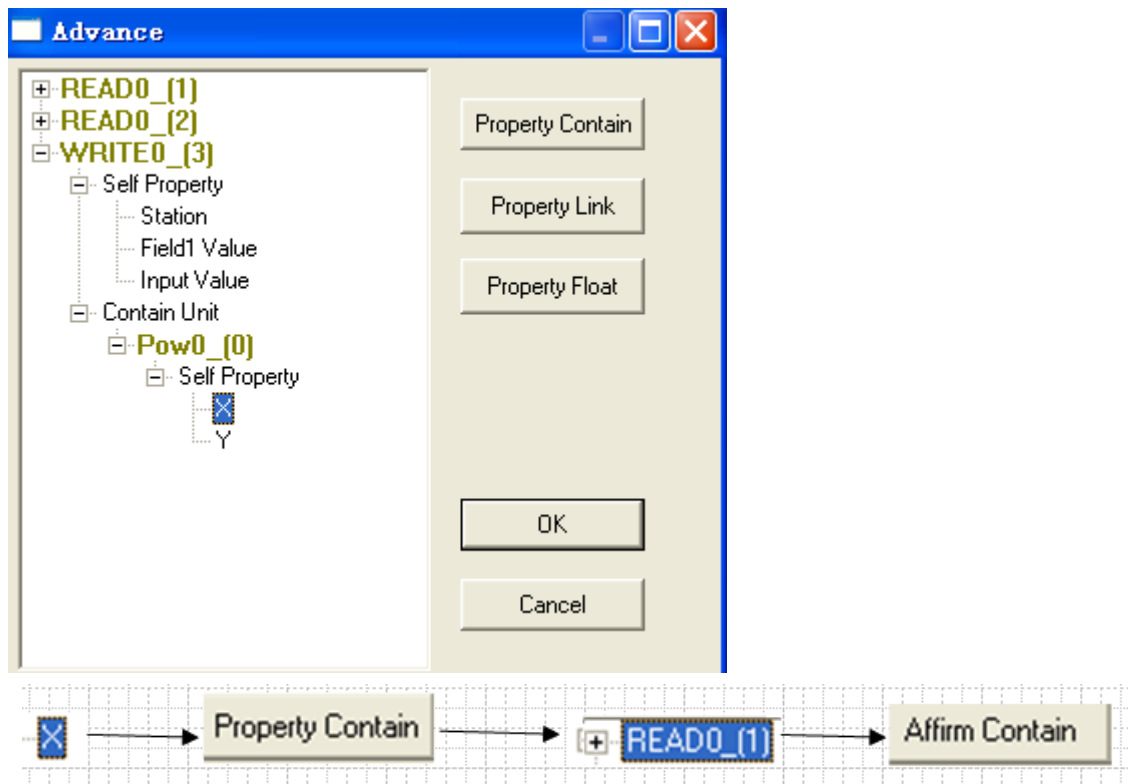

The effects of dialog box:

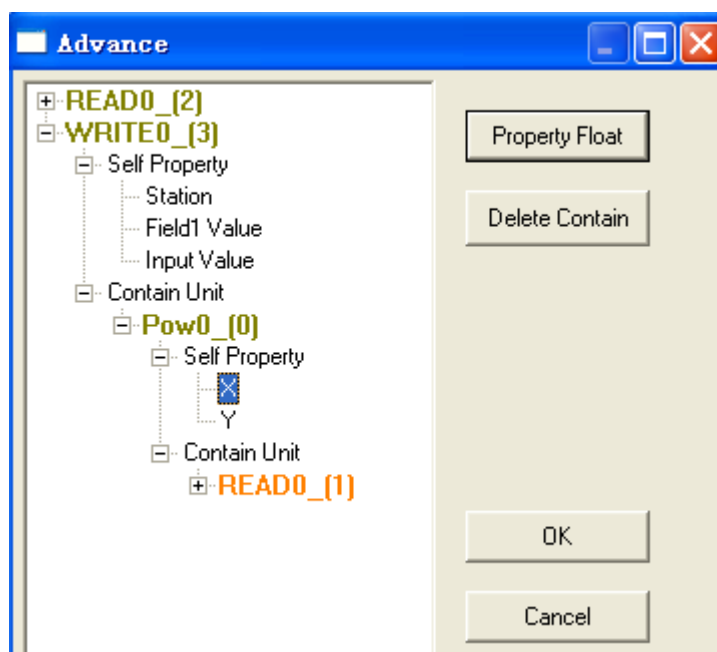

6. Select “Y” to property contain **READ0_2**, the steps are shown below:

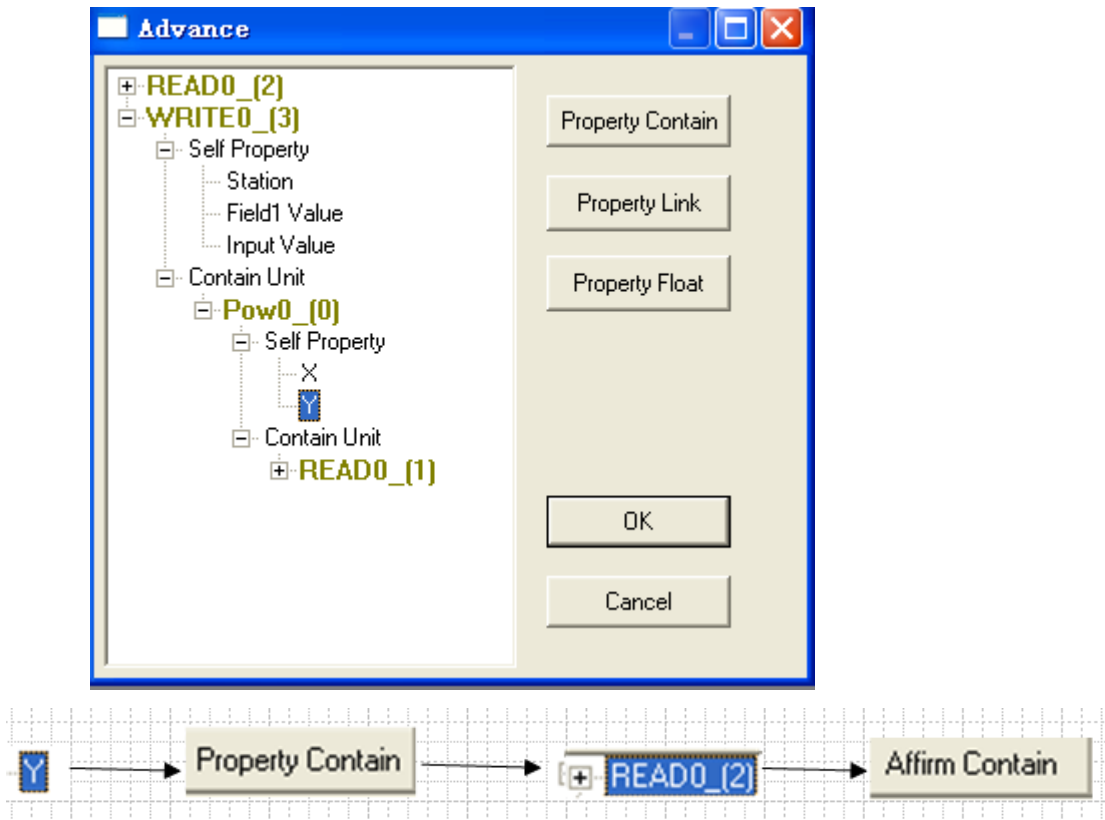

The effects of dialog box:

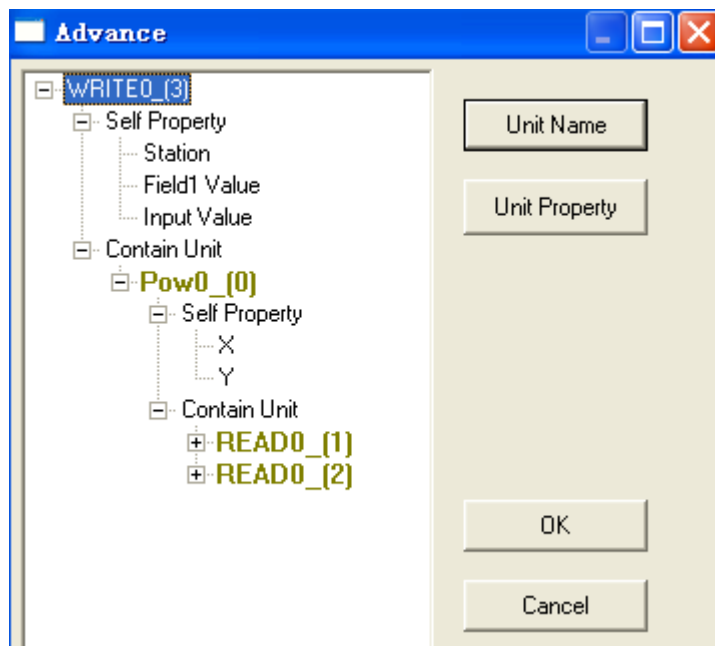

7. At this point, all operations have been completed; the final picture is as follows

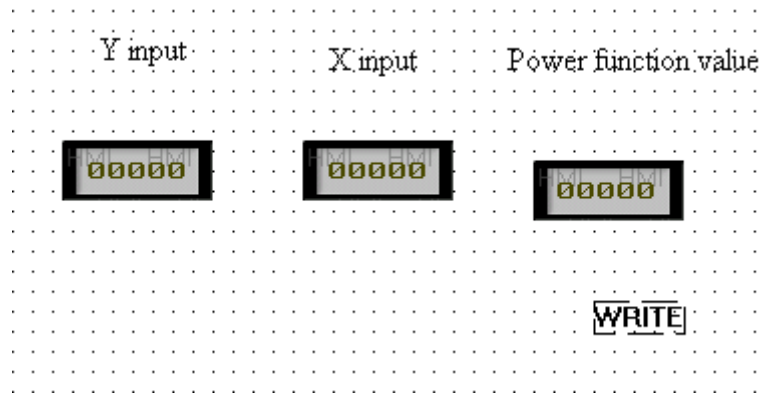

8. Click the “off –line simulation ”  icon on the software, See the following simulation results:

⑤ Y is similar to mathematical index

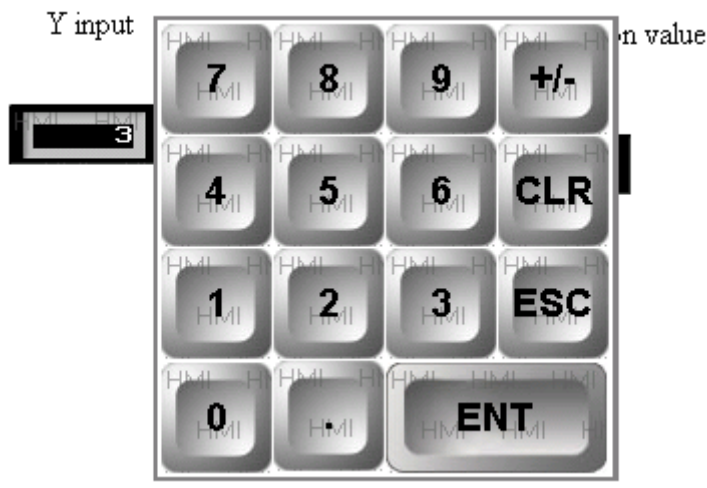

⑤ X is similar to the mathematical base

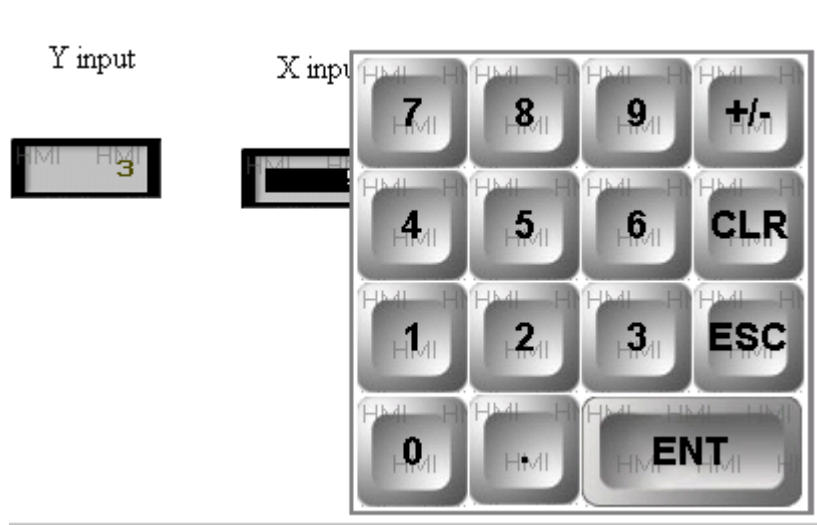

⑥ Read the value of power function

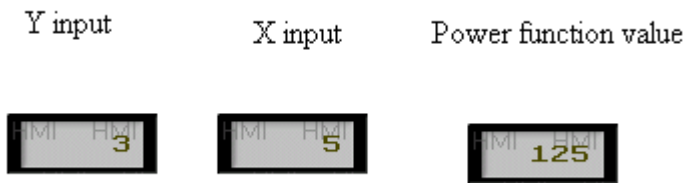

4.2.29 Sqrt

- **Overview:**

This section will introduce the sqrt square root function, similar with sin trigonometric function, arcsin anti trigonometric function, pow function , mainly used in the numerical computations. Referred to earlier sin trigonometric and arcsin anti trigonometric function is a set of positive and negative function, the same to power function and sqrt square root function . The following describes the attributes and function use of pow instruction

- **Property Description:**

Click the software icon  , put sqrt square root function on the screen, double-click it to open property dialog box, as follows:

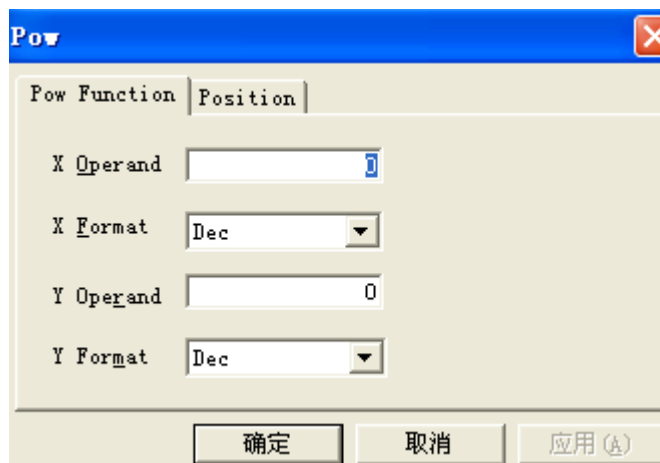





Property Name	Explain
X operand	Implementation of the operation data, similar to the mathematical power function.
X Format	Data Type :Dec、 Hex、 Float、 Unsigned
Y operand	Operands implementation of several actions to develop, similar to the mathematical power function in the index
Y Format	Data Type :Dec、 Hex、 Float、 Unsigned

• **Routine:**

Step1: build screen, place parts

Build a new project, put the following parts on the screen: three text , one digital display

, two digital input , one , two read , one write , as follows:

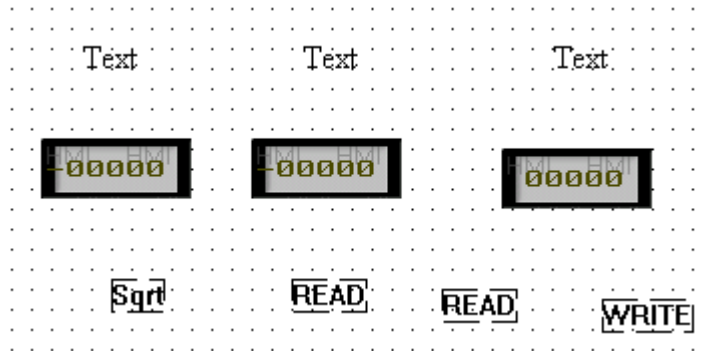

Step2: Modify properties

1. Modify the basic component properties

a. Double-click the left text, open the Properties dialog box, In the text editing area, enter the following text:



b. Double-click the middle text, open the Properties dialog box, In the text editing area, enter the following text:



c. Double-click the right text, open the Properties dialog box, In the text editing area, enter the following text:

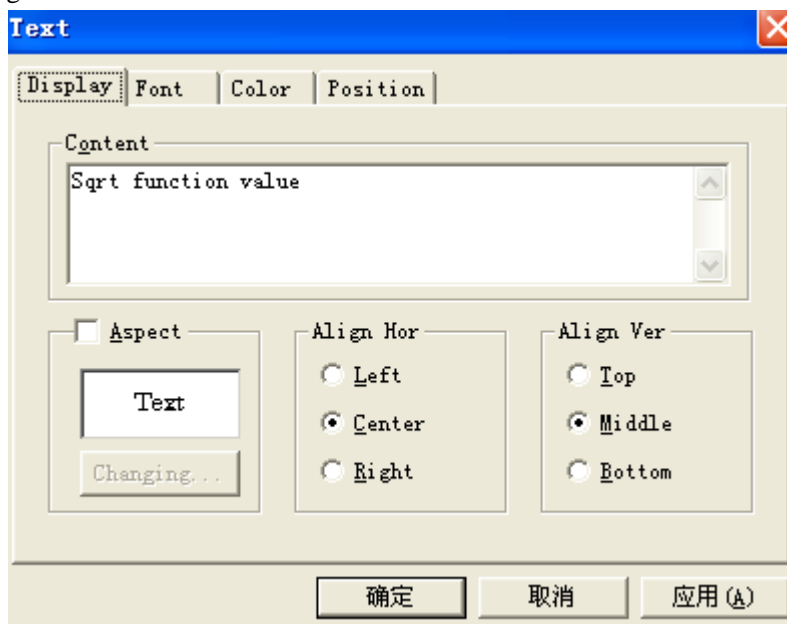

d. Double-click the left “digital input”, open the Properties dialog box, in **Object** option, modify object to PSW300, as follows:

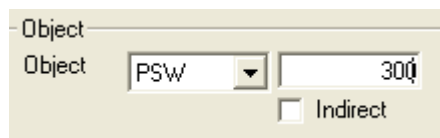

e. Double-click the middle “digital input”, open the Properties dialog box, in **Object** option, modify object to PSW301, as follows:

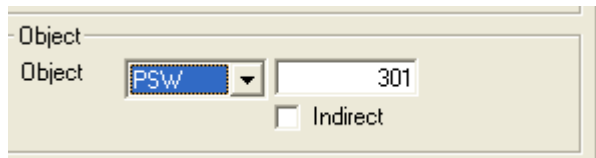

f. Double-click the middle “digital display”, open the Properties dialog box, in **Object** option, modify object to PSW302, as follows:

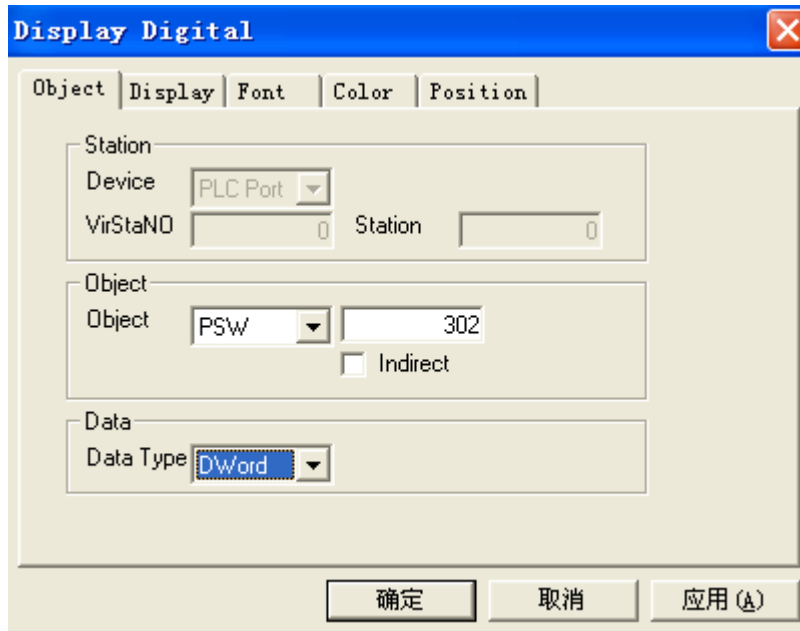

g. In the display option, set **Format** as **Float**, in the **Bit Length**, set **Float** as 2, as follows:

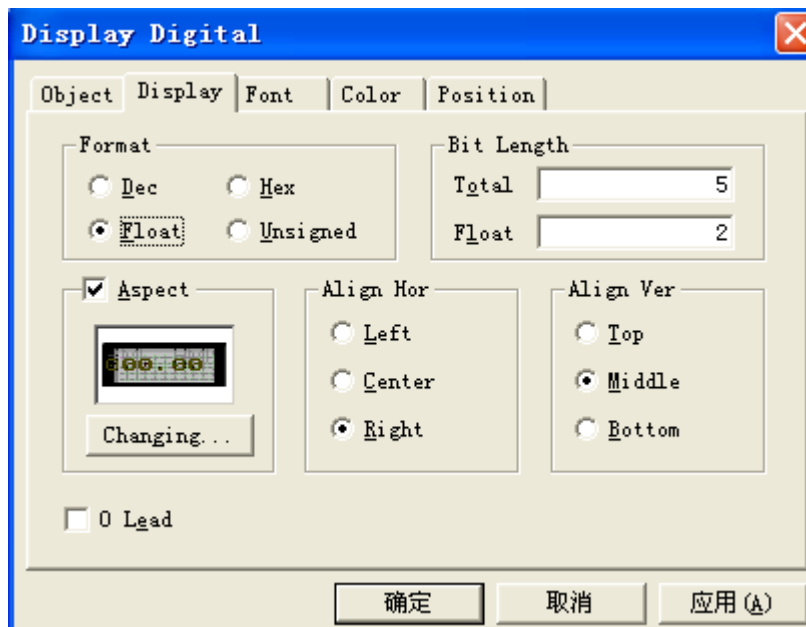

2. Property modification of advanced command.

a. Double-click the left “Read”, open the Properties dialog box, modify **Object** to PSW300, as

follows:



b. Double-click the right “Read”, open the Properties dialog box , modify **Object** to PSW301, as follows:



c. Double-click “Write”, open the Properties dialog box, modify **Object** to PSW302, set data Type as **DWord**, as follows:

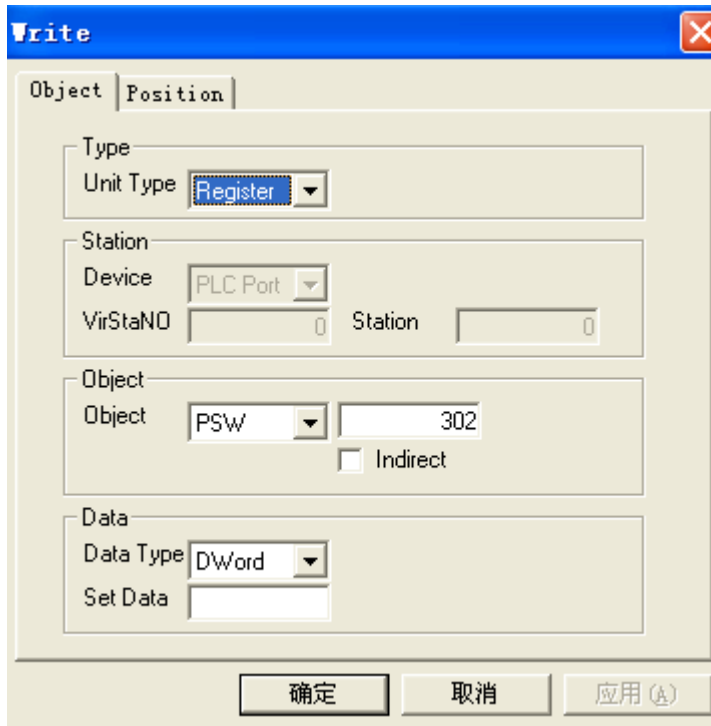

d. Property set belonging to these parts are completed, the final results are as follows:

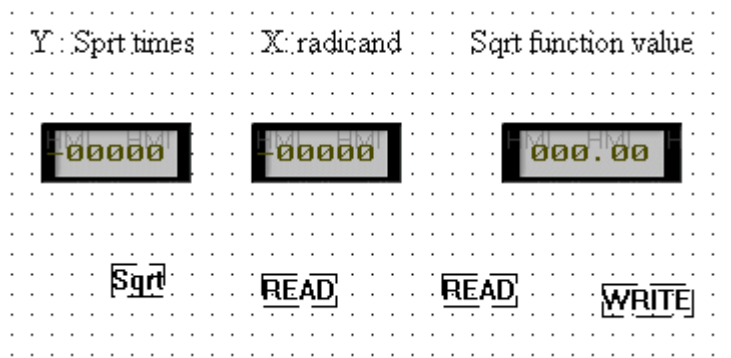



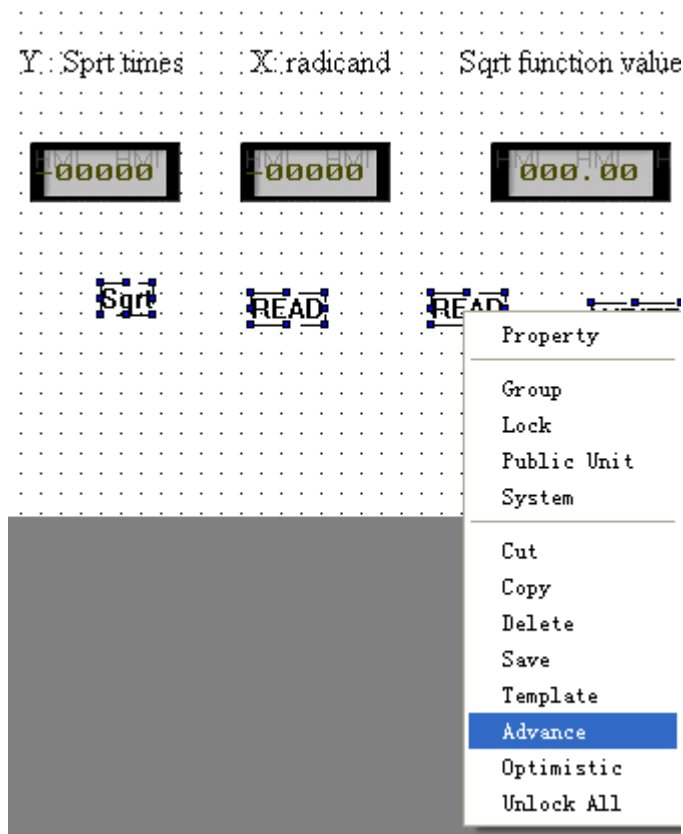

Step3: Advanced Operations

1. Select sqrt、two Read、Write at the same time, Right-click the selected area, choose Advanced ,as follows:

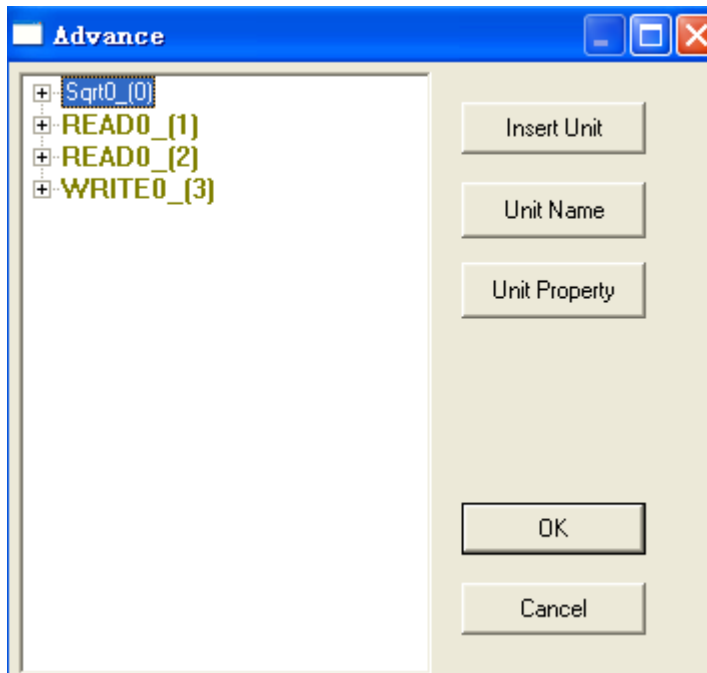

2. Pop-up the following advanced dialog box:



3. Click the small plus sign  in front of directive  , in the self property , select  to property contain  , the steps are shown below:

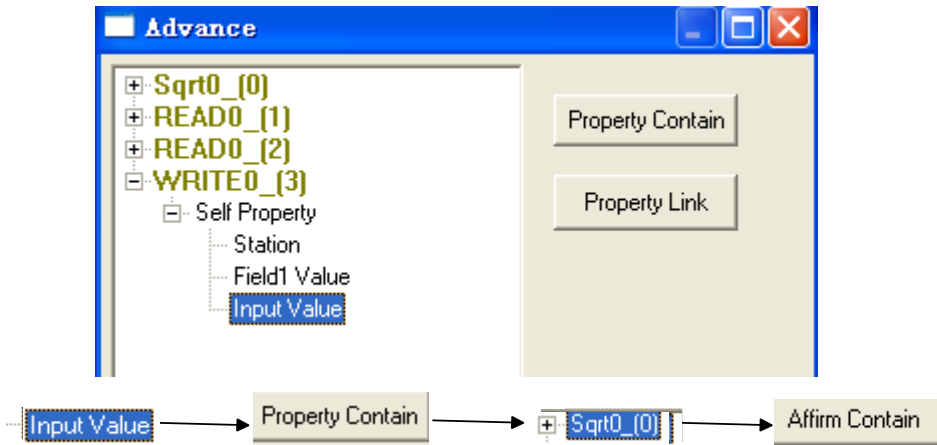

4. Open the self property of **Sqrt0_0**, select X to property contain **READ0_1**, the steps are shown below:

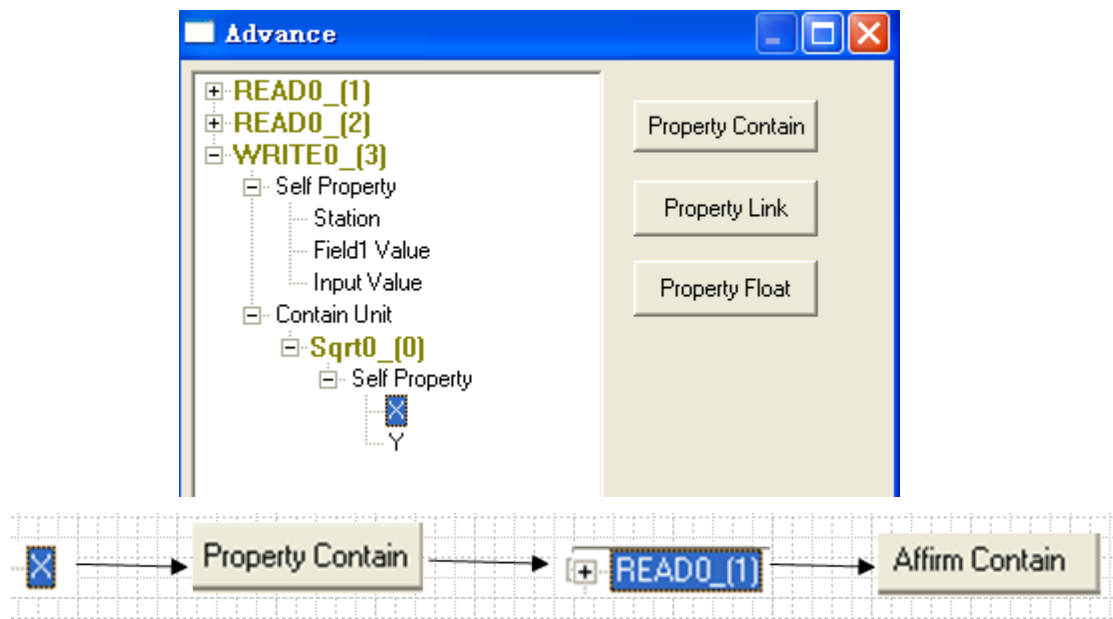

The effects of dialog box:

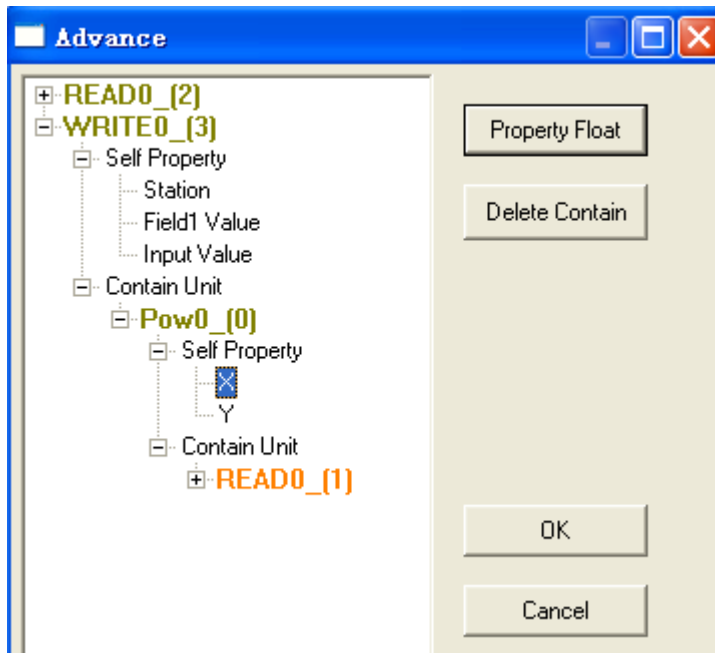

5. Select “Y” to property contain **READ0_2**, the steps are shown below:

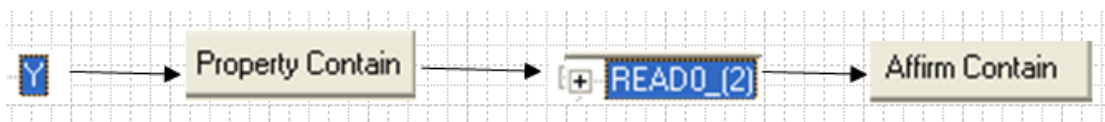
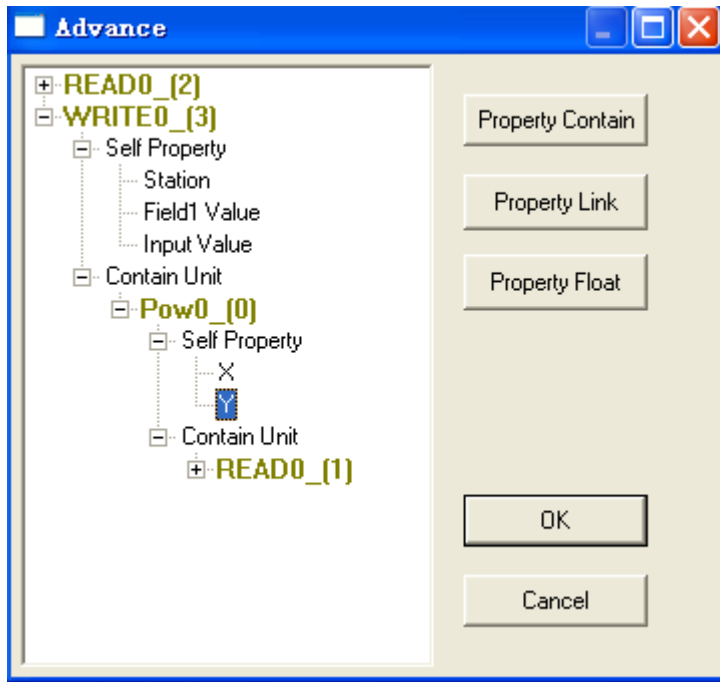

The effects of dialog box:

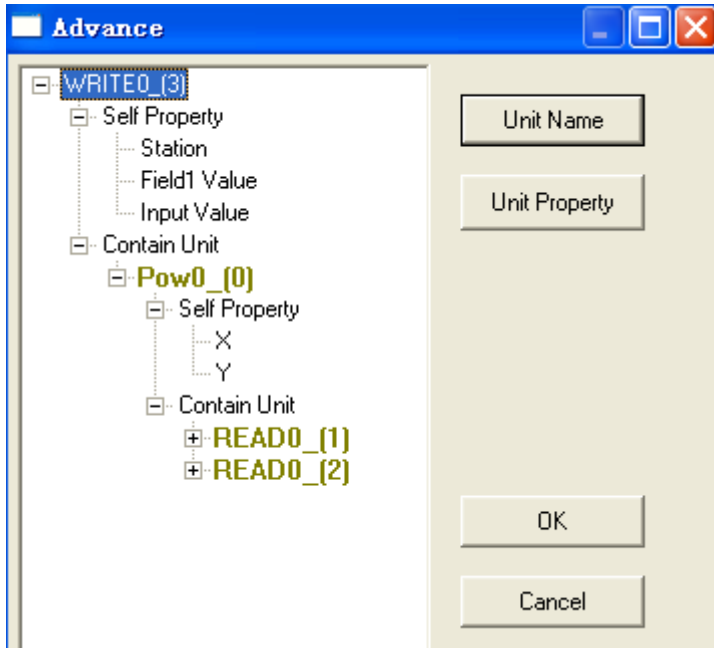

6. At this point, all operations have been completed, the final picture is as follows

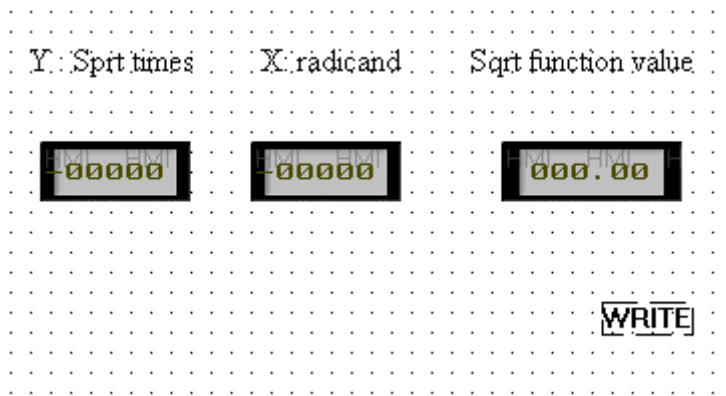

7. Click the “ off –line simulation ”  icon on the software, See the following simulation results:

⑧ Y is similar to Sprt times



⑦ X is similar to radicand

Y : Sqrt times

X: radic

3

6



⑧ Read the value of Sqrt function value

Y : Sqrt times

X: radicand

Sqrt function value

3

64

4.00

4.2.30 Buzzer

- **Overview:**

This section will introduce the buzzer, touch-screen software system built-in buzzer, users can flexibly use it according to the need, such as the system in the alarm, need prompt information to tell the system may appear failure. Here's the Introduction of buzzer's attributes and functions usage

- **Property Description:**

1. Click  icon, put one buzzer component on the screen, Double-click buzzer component,

Open the Properties dialog box, as follows:

Beep option:



Position option:

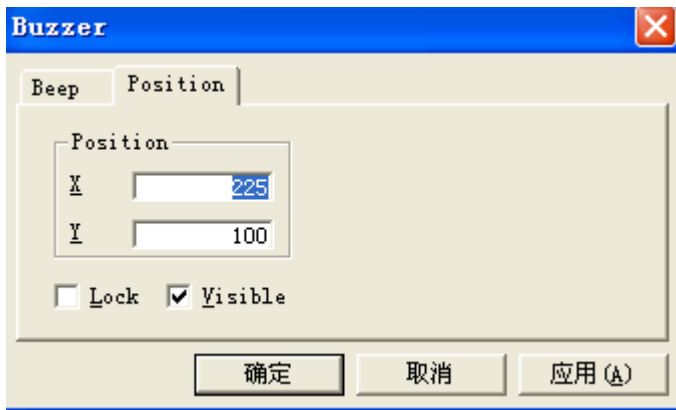

•Routine

Step1: building a screen, placing parts

Building a new screen, placing the following components on the screen: one indicator button

, one buzzer , one , as follows:

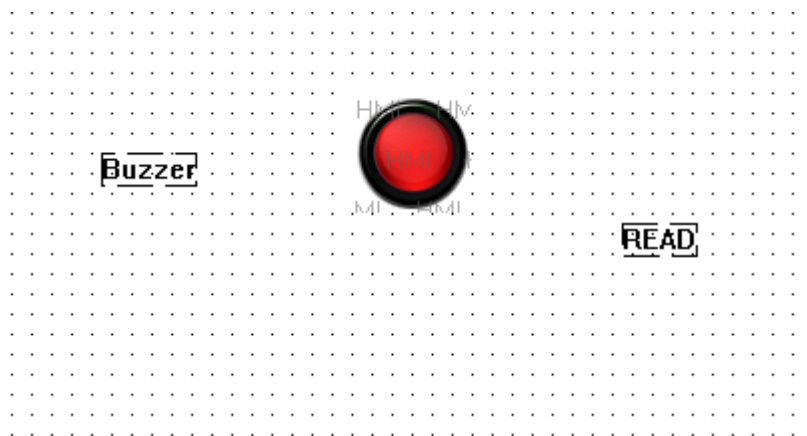

Step2: Set properties

1. Double-click the indicator button to open the Properties dialog box, in **Object** option , modify object to PSB300, as follows:

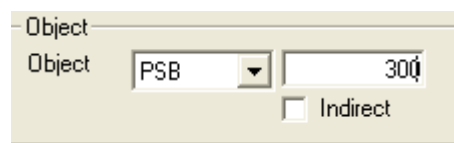

2. In **General** option , modify button operate to **Reverse**, as follows:



3. Double-click “Buzzer”, open the Properties dialog box, set **Diabolo Mode** as **Continue**, as follows:



4. Double-click “Read” component to open the Properties dialog box, in **Object** option , modify object to PSB300, as follows:

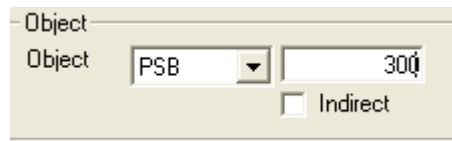

Step3: Advanced Operations

1. Select Buzzer and Read at the same time, Right-click the selected area, choose Advanced ,as follows:

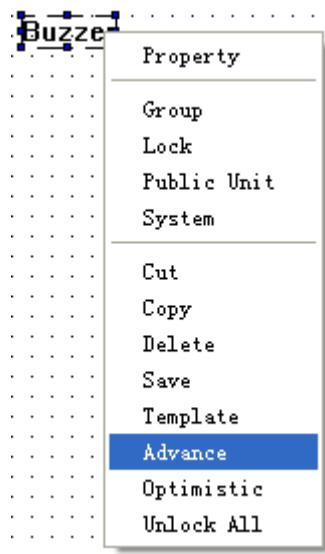

2. Pop-up the following advanced dialog box:

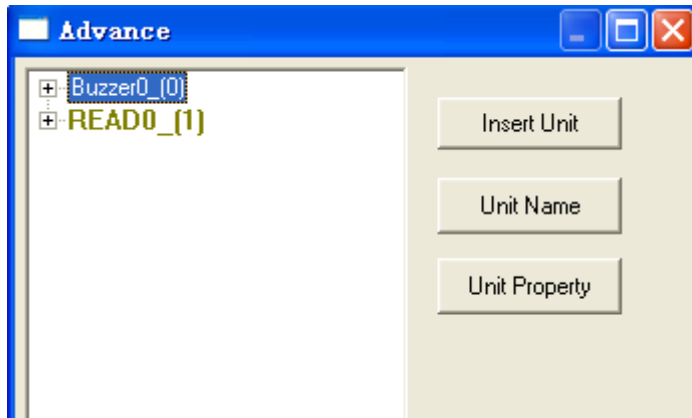

3. Click the small plus sign \oplus in front of directive "Buzzer0_0", Successively click the front plus sign \oplus , open "Buzzer0_0" directive's self property, then select "spring", as follows:

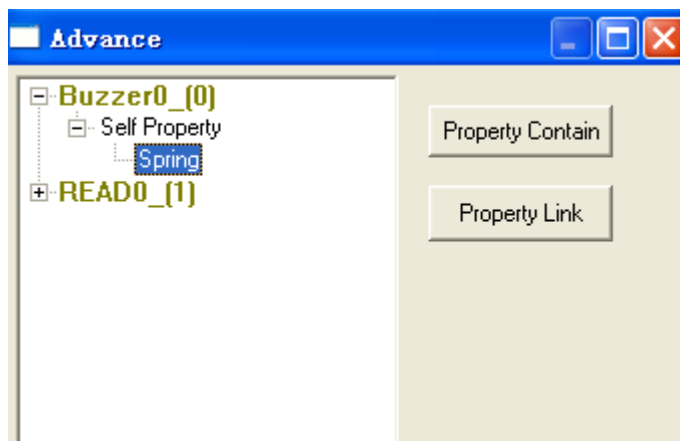

4. Click the right button "Property Contain" in the dialog box, the button will be grayed-out non-operational status, while text changed into "affirm contain", as follows:

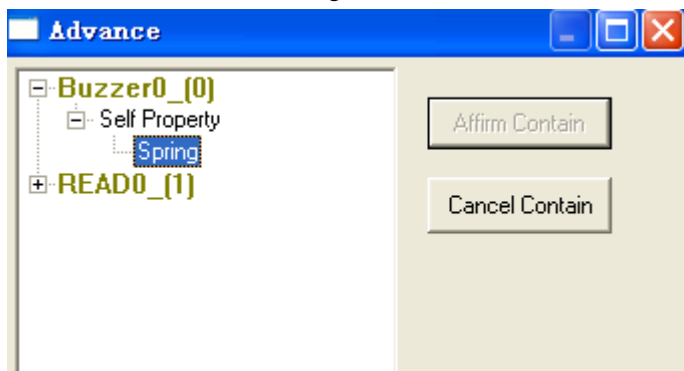

5. Select \oplus "READ0_1", button "Affirm Contain" immediately changed into operational status, then click "Affirm Contain", as follows:

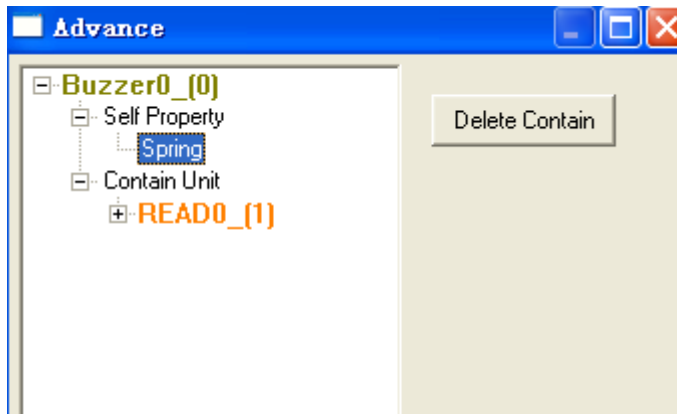

6. Finally click “OK” button, complete advanced operational. The final screen effects are shown below:

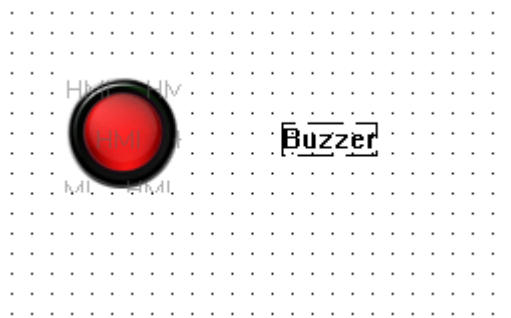

7. Click the “off-line simulation” icon on the software , See the following simulation results:

① Spring value is 0.



② Spring value is 1, at the same time you can hear the buzzer tweet all the time.





4.2.31 Back Light

- **Overview:**

User who often use touch-screen should be familiar with the screen Protection (that is, whether turn off back light). With the advances in technology for industrial touch-screen have become increasingly demanding, we have a high requirement on the touch screen at the same time should pay attention to the use of protective measures, In which the use of background light is one of a kind, Users can directly through the software system configuration to set the background light can also through advanced command to control the background light. Here we will introduce advanced instruction background light component.

- **Routine**

Step1: building a screen, placing parts

Building a new screen, placing the following components on the screen: one text , one back light , one Read component . as follows:

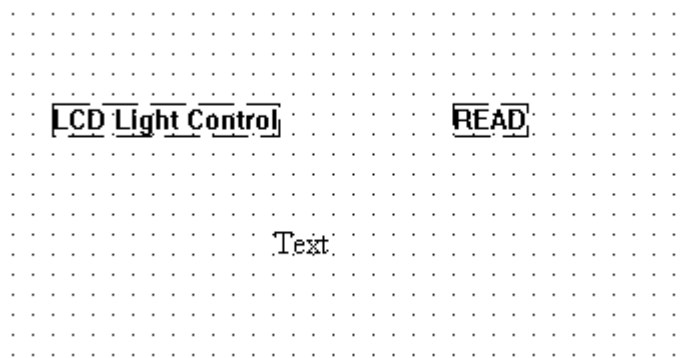

Step2: Set properties

1. Double-click “Text” to open the Properties dialog box, In the text editing area, enter the following text:

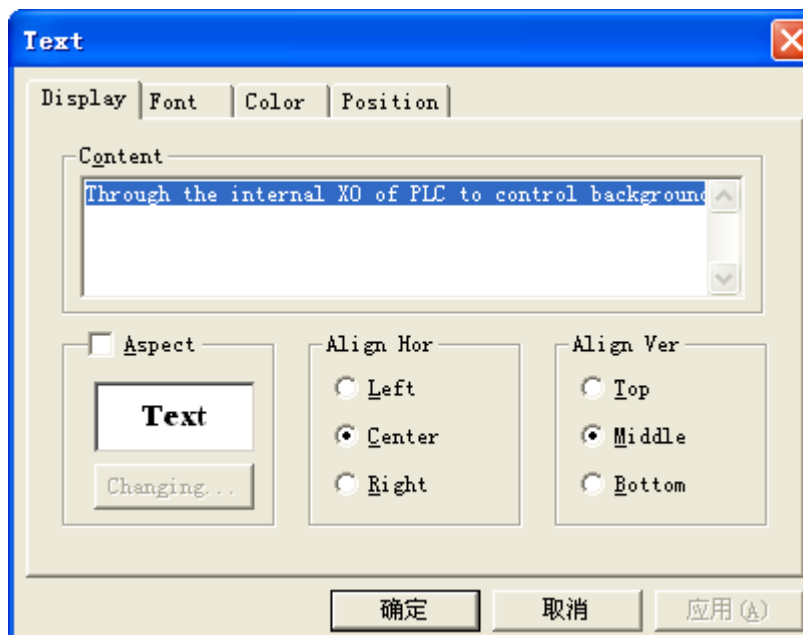

2. Double-click “Read” component , point object to X0, as follows:

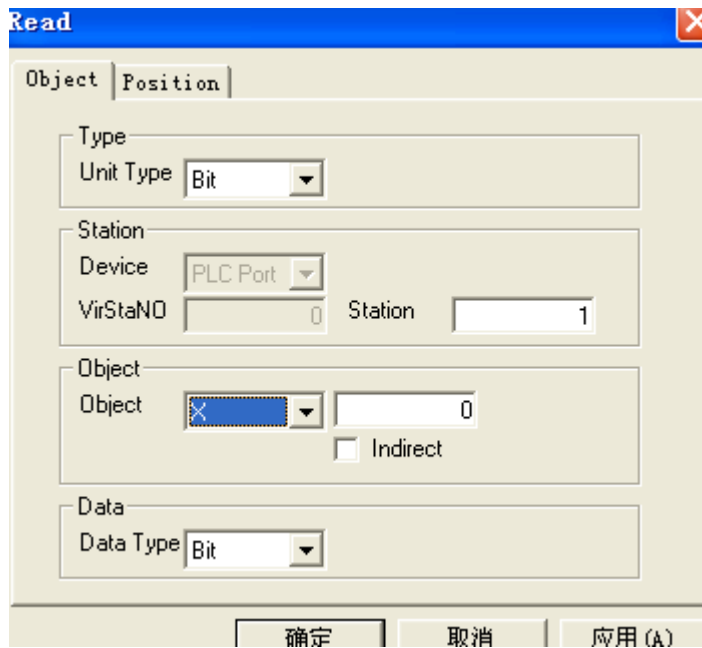

3. The final screen effects are shown below:

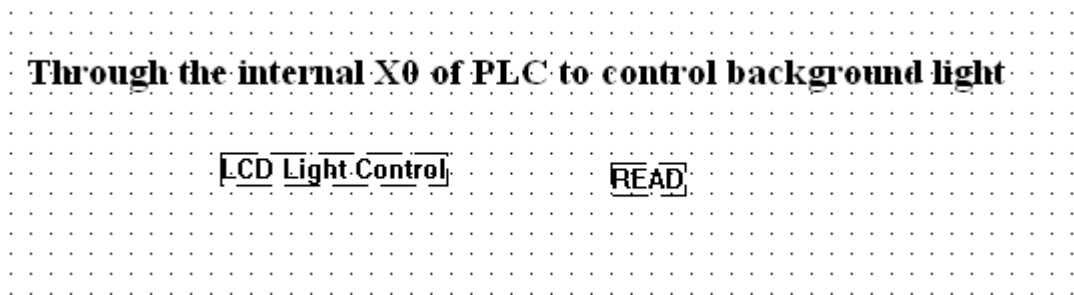

Step3: Advanced Operations

1. Select the Back light and Read at the same time, Right-click the selected area, choose Advanced:

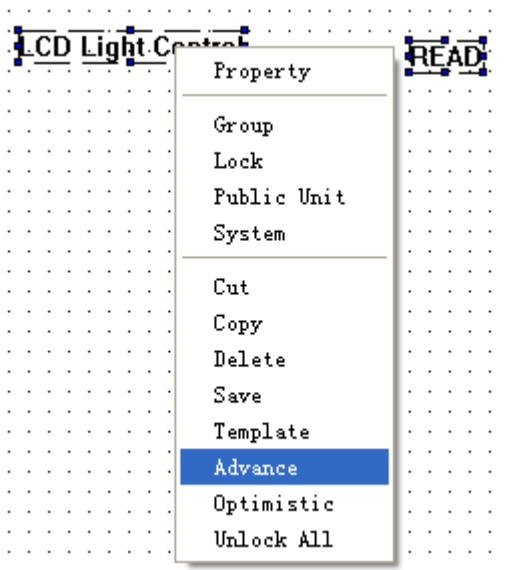

2. Pop-up the following advanced dialog box:

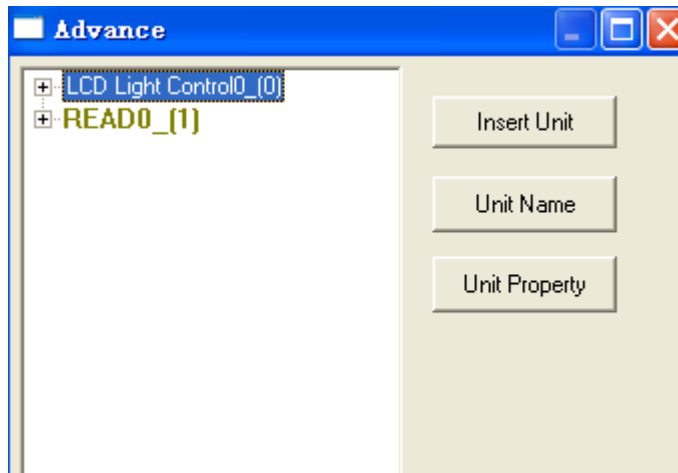

7. Click the small plus sign \oplus in front of directive \oplus `LCD Light Control0_0` , Successively click the front plus sign \oplus , open \oplus `LCD Light Control0_0` directive's self property, then select "spring", as follows:

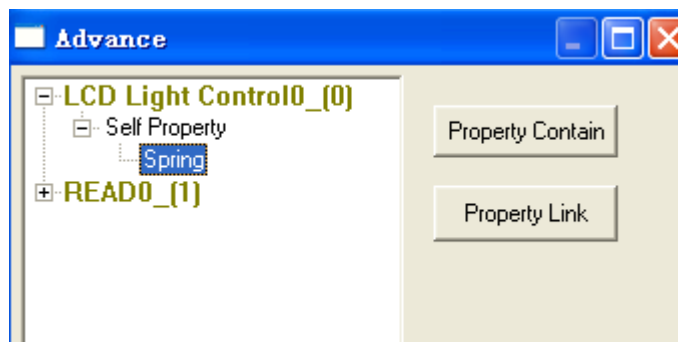

4. Click the right button `Property Contain` in the dialog box, the button will be grayed-out non-operational status, while text changed into "affirm contain", as follows:

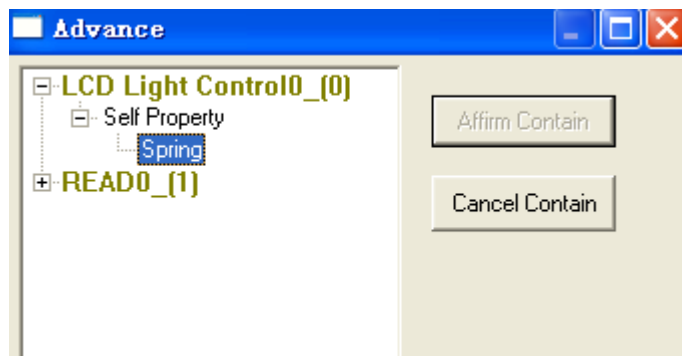

5. Select \oplus `READ0_1` , button `Affirm Contain` immediately changed into operational status , as follows:

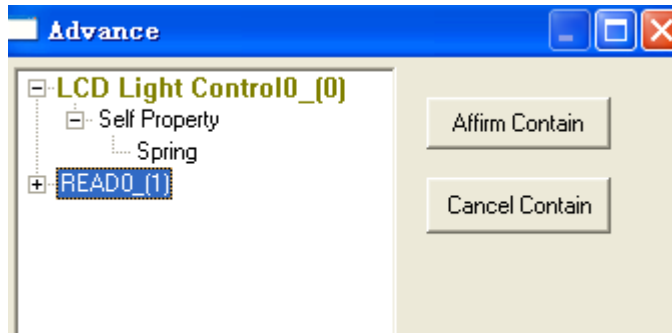

6. Click **Affirm Contain** button, complete property contain , as follows:

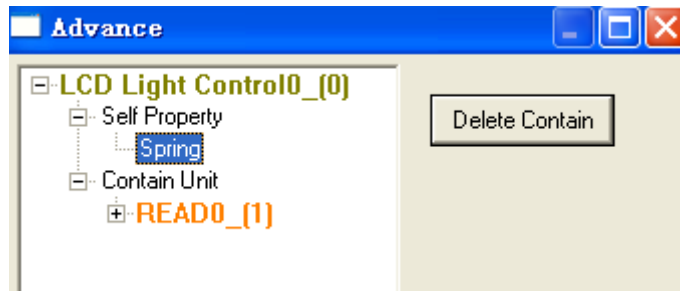

7. Finally click “ok” to complete the advanced operations, the final screen shown below:

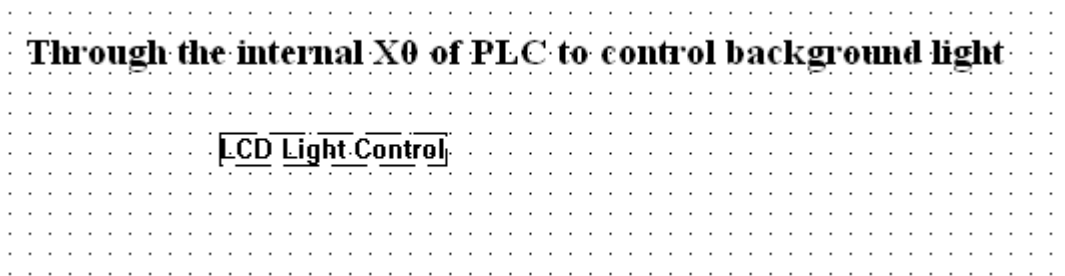

Step4: The system back light settings

1. Open **File**, In the drop-down list to select **Setting... Ctrl+T**, as follows:

File	Edit	View	Part	To
<u>N</u> ew				Ctrl+N
<u>O</u> pen...				Ctrl+O
<u>C</u> lose				Ctrl+Q
<hr/>				
<u>S</u> ave				Ctrl+S
Save <u>A</u> s...				Ctrl+A
<hr/>				
<u>D</u> ownload				Ctrl+D
Run <u>O</u> nLine (<u>B</u>)				Ctrl+B
Run <u>O</u> ffLine (<u>M</u>)				Ctrl+M
<hr/>				
P <u>F</u> W Set (<u>P</u>)				Ctrl+P
<u>S</u> etting...				Ctrl+T
<hr/>				
Build SCADA				
Last File				
<hr/>				
<u>E</u> xit				

2. In the Pop-up advanced dialog box, click **Para** button, set **Latency Time** as **After 1 Minute**, click “OK” to complete the setting, as follows:

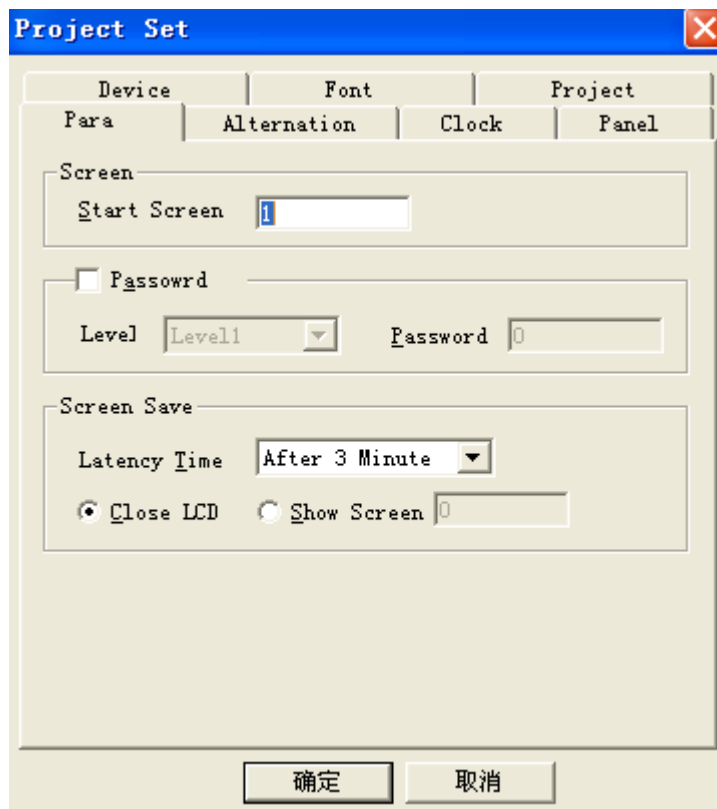

3. Download the program to the touch screen. X0 default OFF state, observe the touch screen, you will find 1 minute later, touch-screen background light will turn off, at this time trigger X0 input point to set as ON state, touch-screen background light will turn on immediately.

4.2.32 Serial port send

- **Overview:**

This section will introduce the serial port send, its role is real important to send data to the individual, In practice, many users want can only external device send data to the touch screen but touch screen is unable to send data to touch screen. Can only receive data sent by external devices when necessary, through the serial port to send a command to an external device. Here are the properties of function and serial port to send feature. Here introduce the property function and function use of serial port to send.

Property Description:

Click the software Icon , Serial port to send component can be placed on the screen,

Double-click cycle component, Open the Properties dialog box, as follows:

Serial port to send options

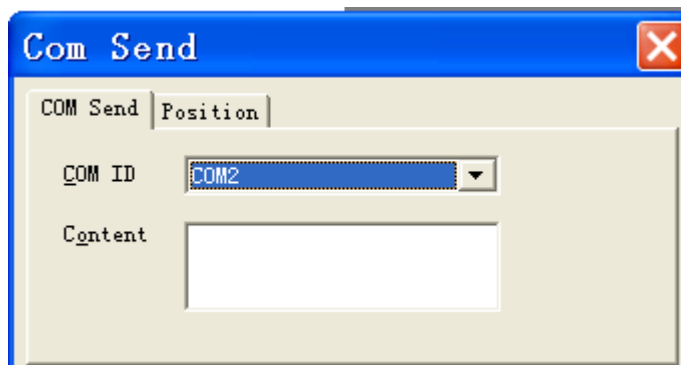

Property Name	explanation
Serial Number	Select touch-screen device port that sends data to an external device .
Send Content	the information you want to publish on the external device

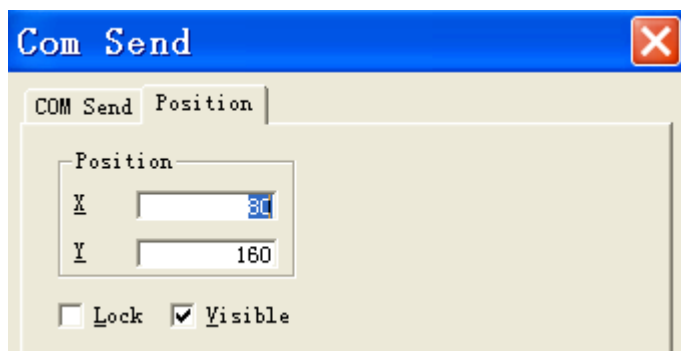





Property Name	explanation
position	the location of Serial port to send component on the screen, Formed by the X position and Y position. Users can enter data in the X and Y position input box to change the location of component, You can also through dragging the component to change its position.
Lock	When selected, the component location is fixed, can not be moved freely, otherwise, on the contrary
Visible	Check box is selected, the component visible on the screen, otherwise not visible.

●**Routine**



Here introduce the use of serial port send function through a simple operation.

Step1: building a screen, placing parts

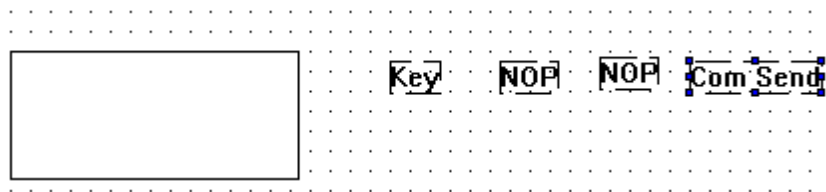
Building a new screen, placing the following components on the screen: one rectangular , one advanced command button , two NOP advanced command  N, one Serial port send advanced command , as follows:



Step2: Set properties

1. Double-click the button to open the Properties dialog box, in the  option , setting  to 200 and setting  to 100. as follows:

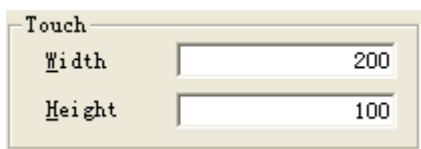

2. Screen Effects

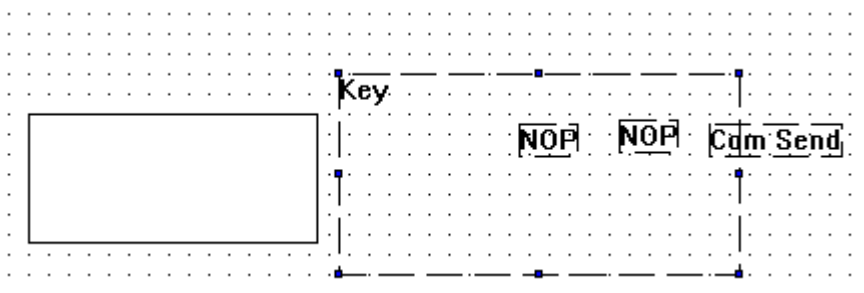



3. Double-click Com send component, open the Properties window, in the ‘Send Content’, enter the following:

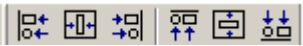

Step3: Advanced Operations

1. Select the rectangle, key, two Nop and Com send at the same time, in the alignment icon on the

toolbar , click align center , align middle , as follows:

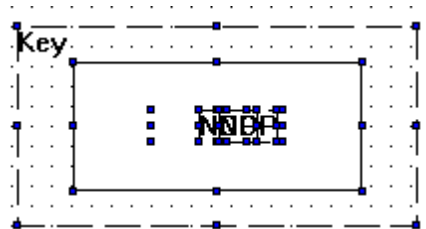

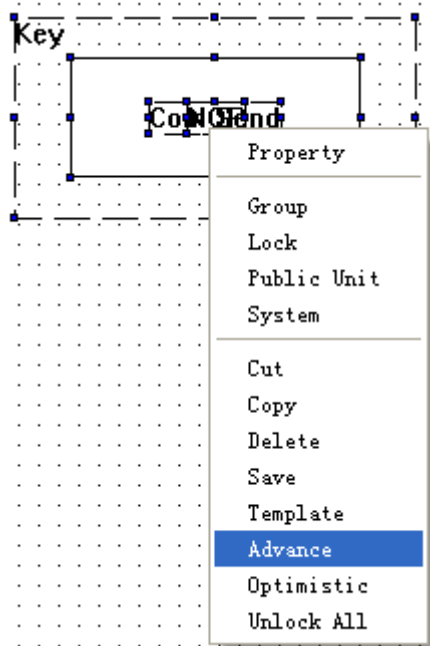

2. Right-click the selected area, choose Advanced:

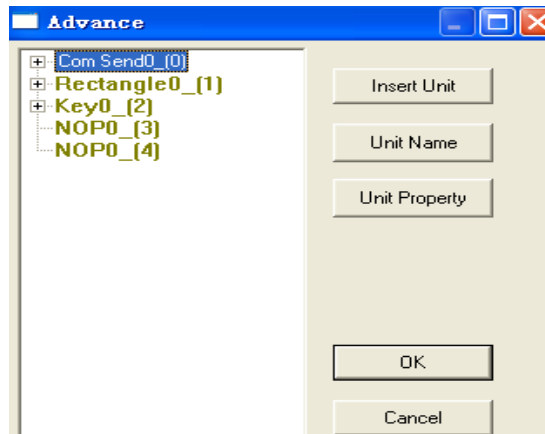

3. Pop-up the following advanced dialog box:



4. Select  **Rectangle0_ (1)** , Click the right button  in the dialog box, the button will be grayed-out non-operational status, while text changed into “affirm insert”, as follows:

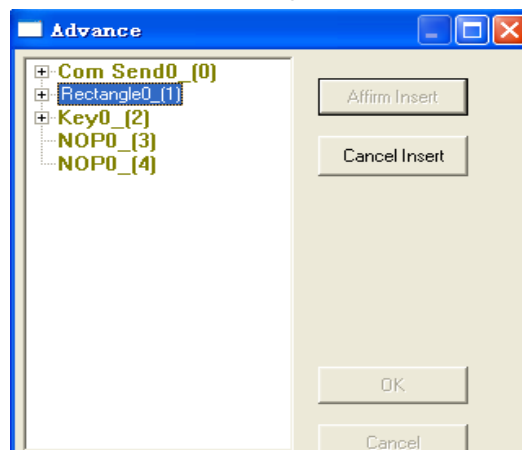

5. Select  **Key0_ (2)** , button immediately changed into operational status , as follows:

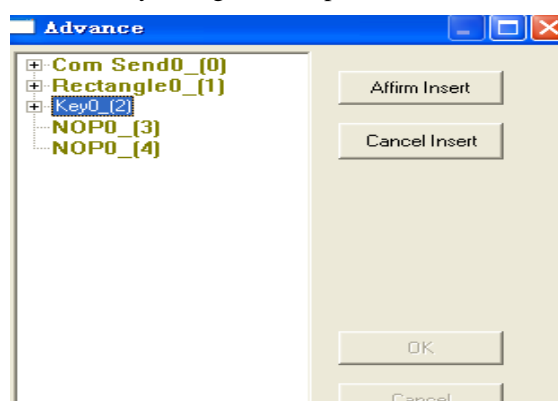

6. Click  button, complete  **Key0_ (2)** Component insertion.

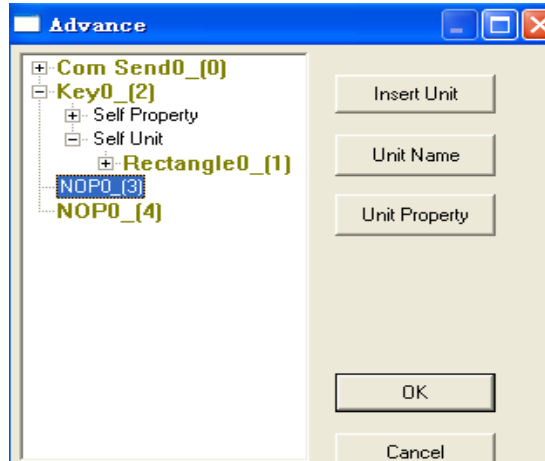

7. Select **NOP0_(3)** , Click the right button **Insert Unit** in the dialog box, the button will be grayed-out non-operational status, while text changed into “affirm insert”, as follows:

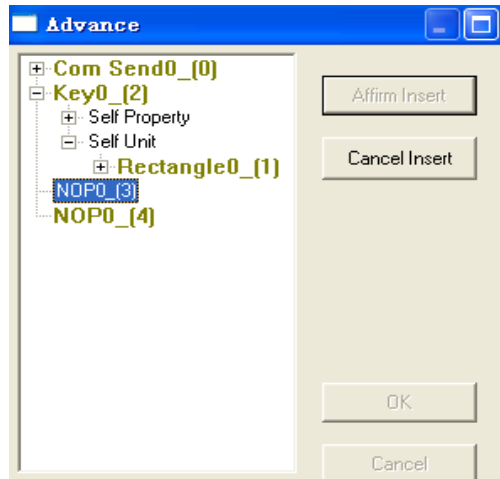

8. Select **Key0_(2)** , button immediately changed into operational status , as follows:

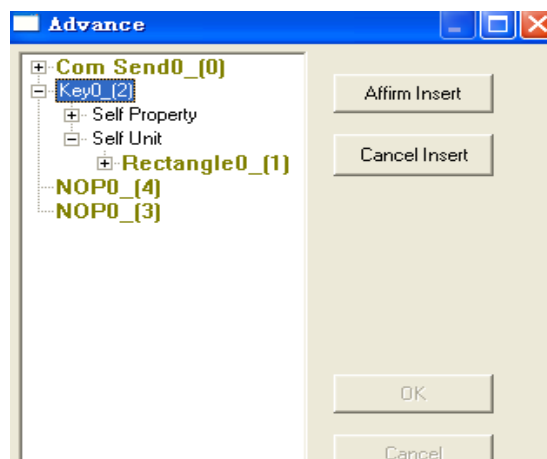

9. Click **Affirm Insert** button, complete **Key0_(2)** Component insertion.

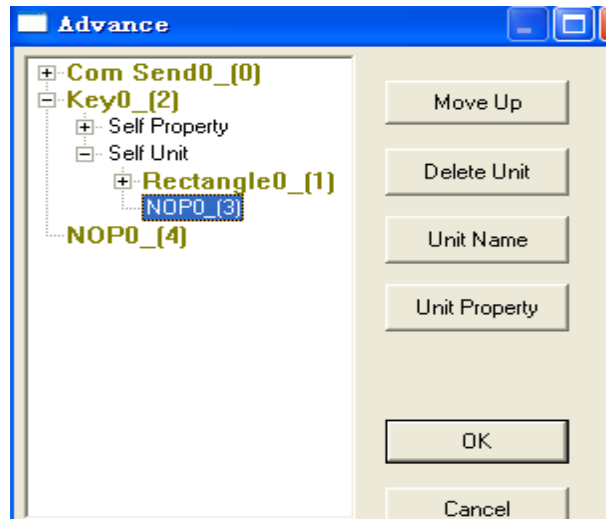

10. Select **NOP0_4** , Click the right button **Insert Unit** in the dialog box, the button will be grayed-out non-operational status, while text changed into “affirm insert”, as follows:

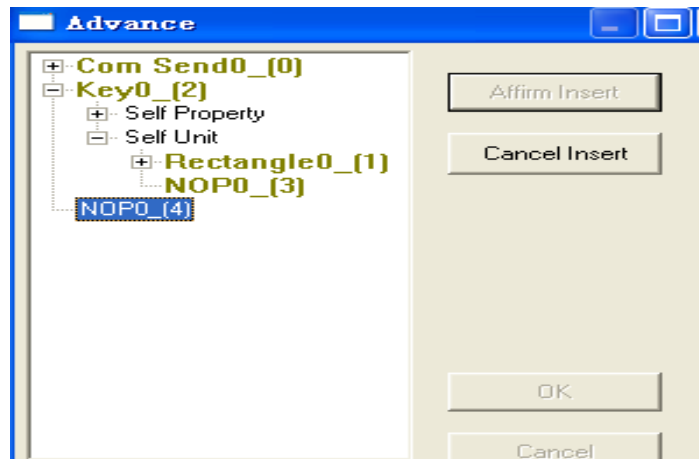

11. Select **Key0_2** , button immediately changed into operational status , as follows:

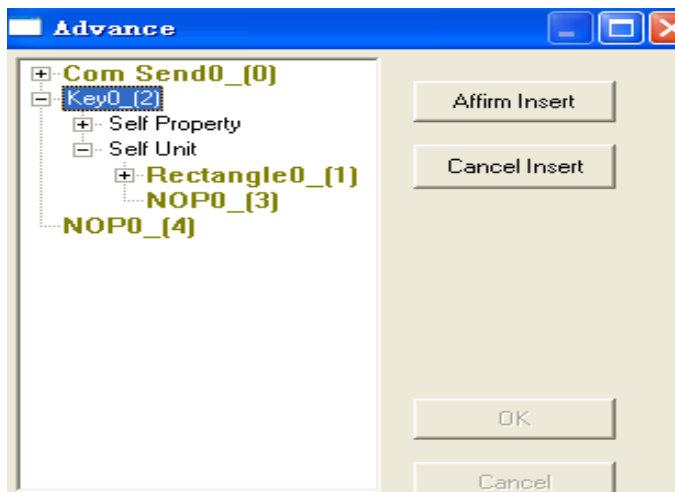

12. Click  button, complete  Component insertion.

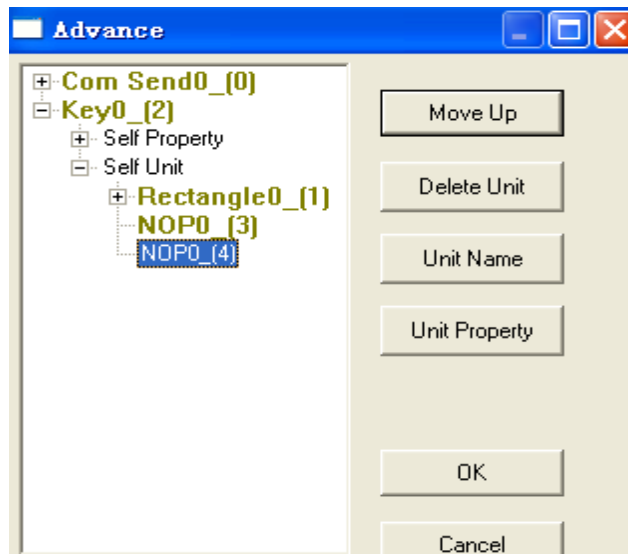

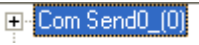
13. Select , Click the right button  in the dialog box, the button will be grayed-out non-operational status, while text changed into “affirm insert”, as follows:

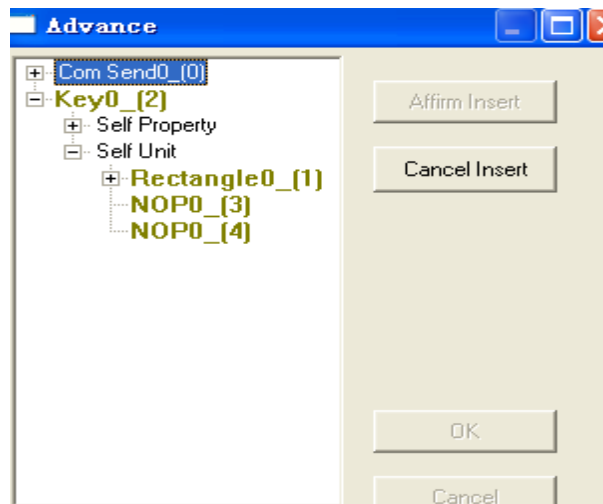

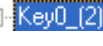
14. Select , button immediately changed into operational status, as follows:

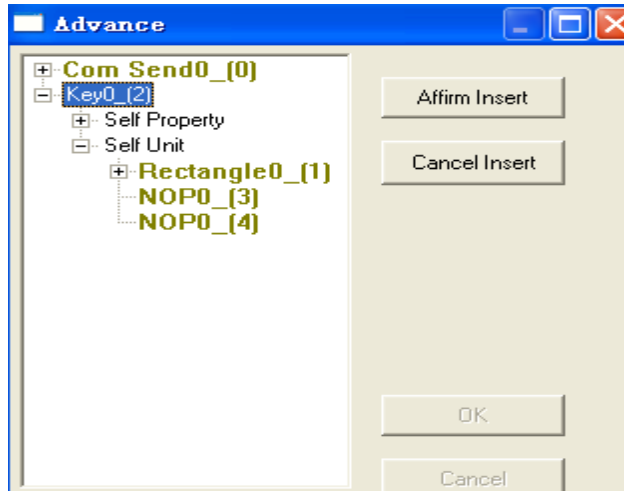

15. Click button, complete  Component insertion.

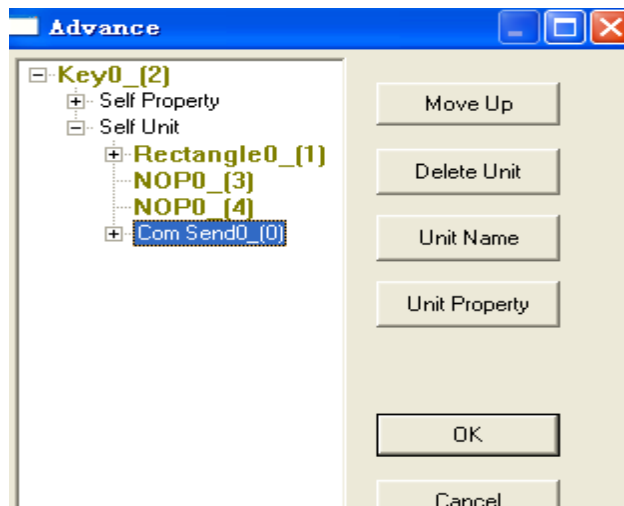

16. Finally click button, Advanced operations are completed. The final screen effects are shown below:

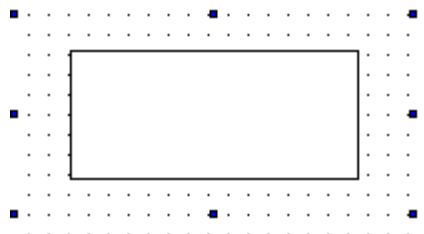

17. Download to the touch screen, insert touch screen RS232 programming port to the PLC port,



open Thinget Serial debugging tools T-COM, monitoring data through

touch-screen sent to the PLC port, Data are as follows:

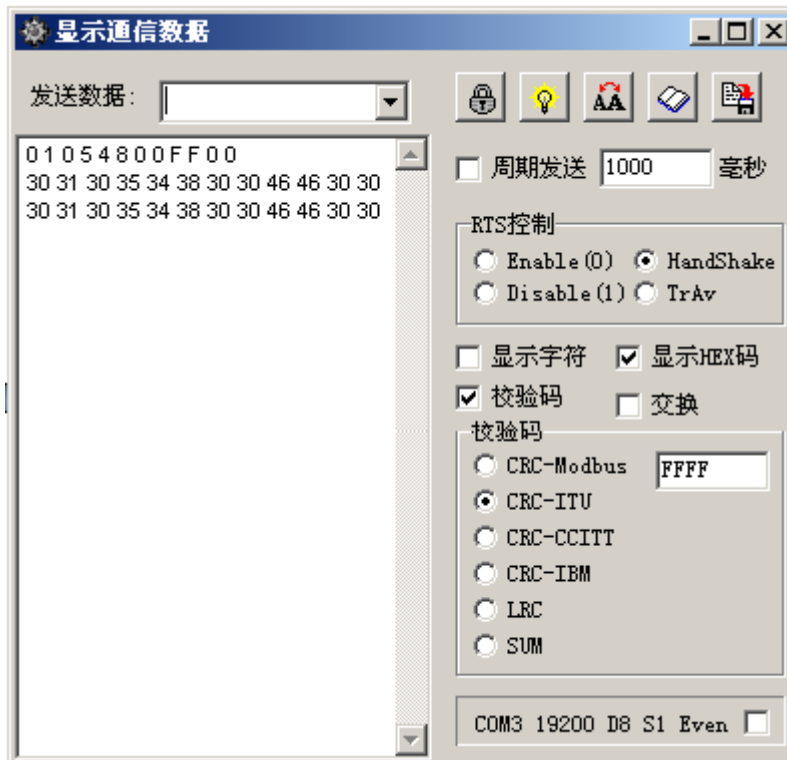

4.2.33 Cycle element

• Overview

This section will introduce the cycle component of advanced instruction, Users are familiar with C language environment, should be an understanding of For loop. But the the cycle component of touch-screen advanced instruction and C also have some difference, The following will introduce its attributes and the use of functions.

• Property Description

Cycle is repeatedly executing some statements of program. Similar to C, One group statements, repeatedly execute, were called loop, Can

Continue to repeat, determined by the termination conditions of the cycle. Loop statements formed by loop and loop termination conditions of the two parts.

Click the software icon , placing the loop component on the screen,

Double-click cycle component, open the Properties dialog box, as follows:

Loop option:

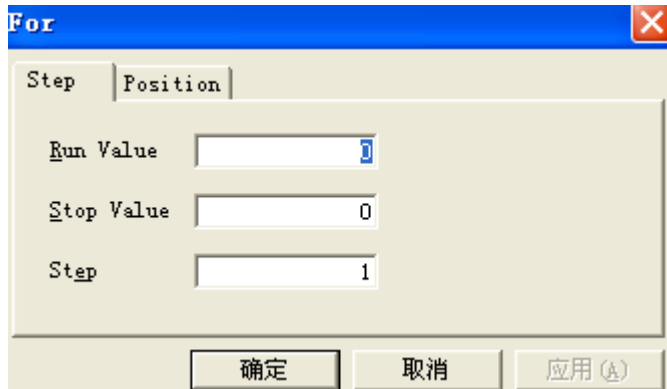

Property Name	Explanation
Run value	
Stop value	
Step	

Position option:

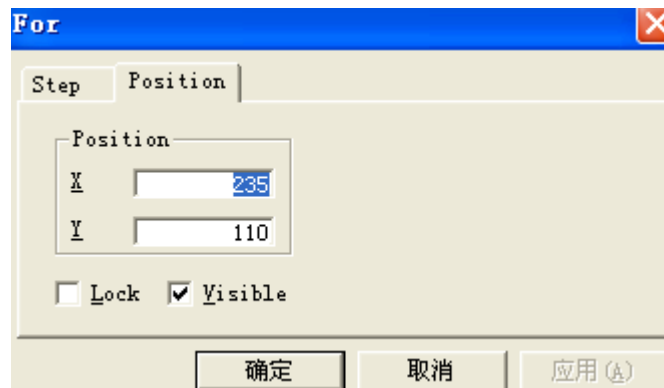

Property Name	explanation
position	the location of Serial port to send component on the screen, Formed by the X position and Y position. Users can enter data in the X and Y position input box to change the location of component, You can also through dragging the component to change its position.
Lock	When selected, the component location is fixed, can not be moved freely, otherwise, on the contrary
Visible	Check box is selected, the component visible on the screen, otherwise not visible.









At this point the properties introduction of circular element have been finished.

● **Routine**

In the beginning of this section has already been mentioned the use of cycle component function, the following we will specifically introduce the use of cycle component function

Step1: Building a screen, placing parts

Building a new screen, placing the following components on the screen: one digital input

, one Indicator button , one function button , one For advanced command , one If advanced command , one , one , three read advanced command  two write advanced command , as follows;

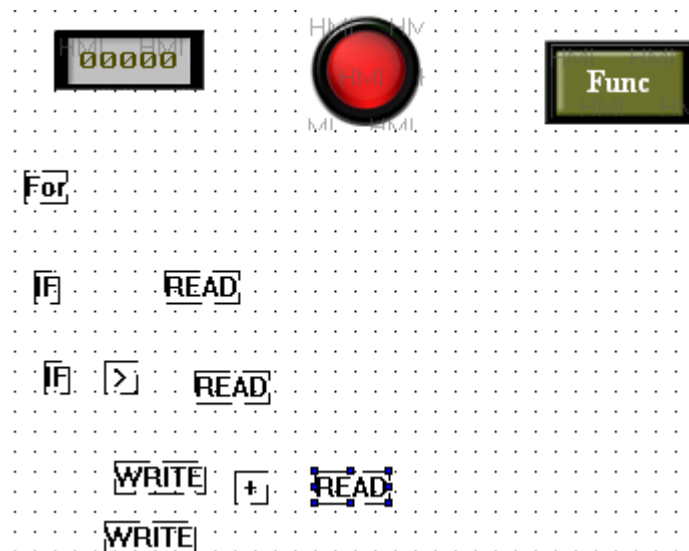

Step2: Modify properties

1. Modify the basic component properties

a. Double-click “digital input”, open the Properties dialog box, in **Object** option , modify object to PSW300, as follows:

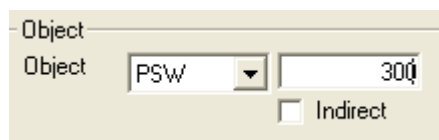

b. Double-click “Indicator button”, open the Properties dialog box, in **Object** option , modify object to PSB300, in **General** option , modify button operate to **Reverse** , as follows:

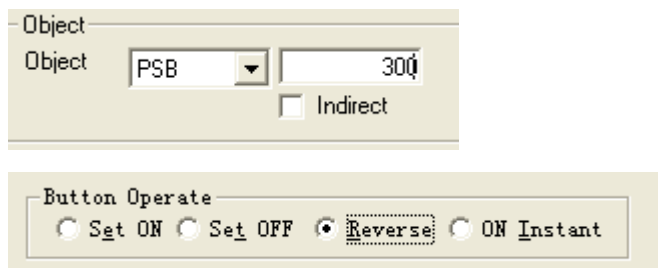

c. Double-click “function button”, open the Properties dialog box, as follows:

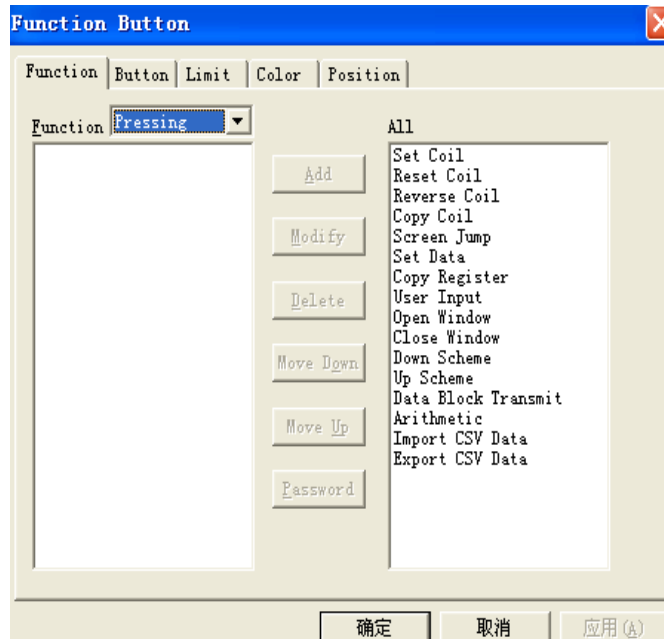

d. Open **Function** option, in the right option **All** select “set data”, then click **Add** button, That added a function in the left blank area . As shown on the right :

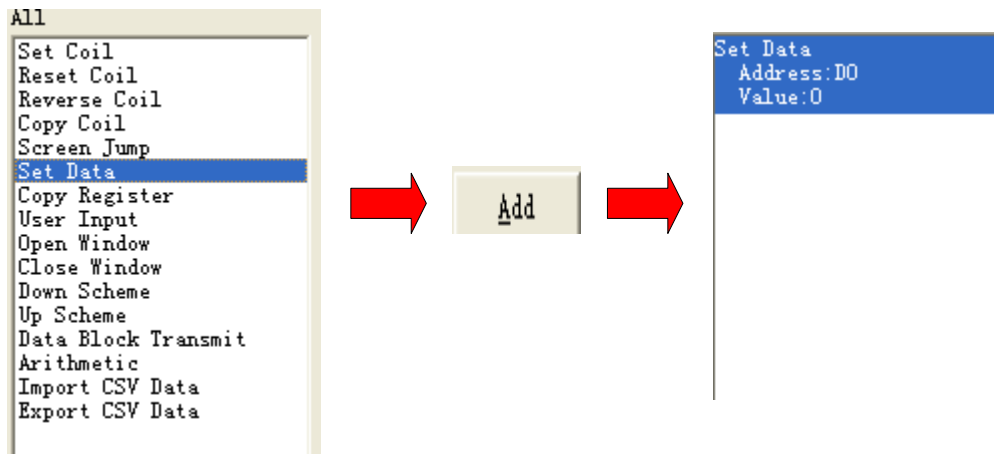

e. Select **Set Data** , Double-click or click the right button **Modify** , open the following Properties dialog box:

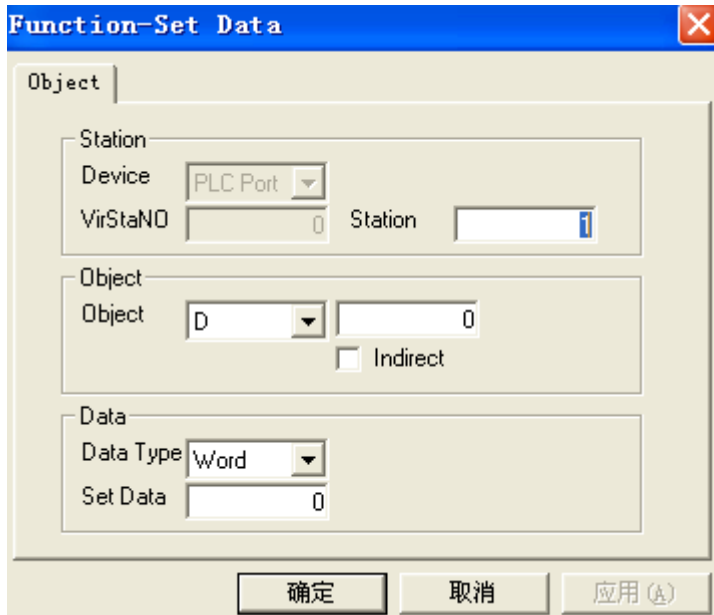

f. Modify object to PSW300, as follows:

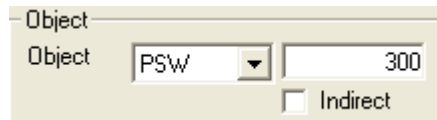

g. Select **Button** option, in the text input box inputting “clear”, as follows:

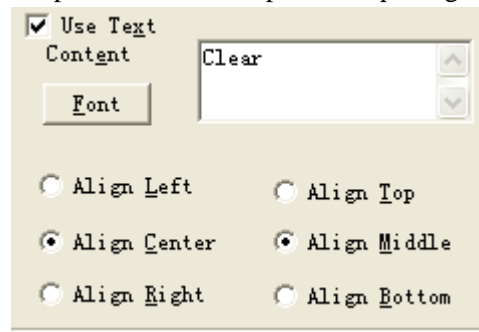

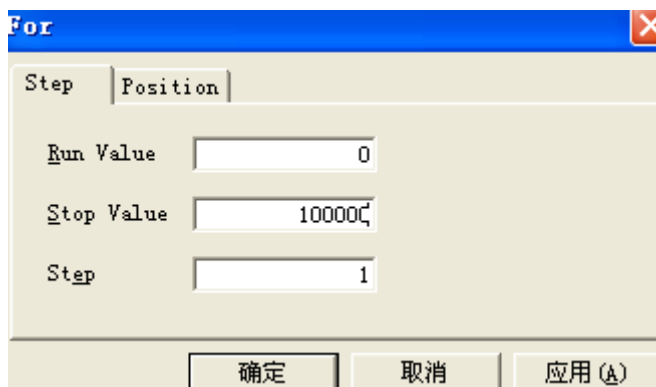

2. Property modification of advanced command.

a. Double-click “For”, open the Properties dialog box , set “stop value” as 100000, as follows:

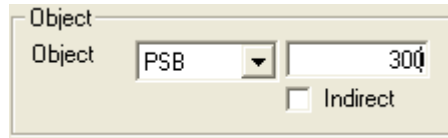

b. Double-click the top “Read”, open the Properties dialog box , modify **Object** to PSB300, as follows:



c. Double-click “compare”  component, open the Properties dialog box , set **Kind** as  , **Right Operand** set to 200,as follows:



d. Double-click the middle of the READ component, open the Properties dialog box ,set **Unit Type** as  , **Object** set to PSW300,as follows:

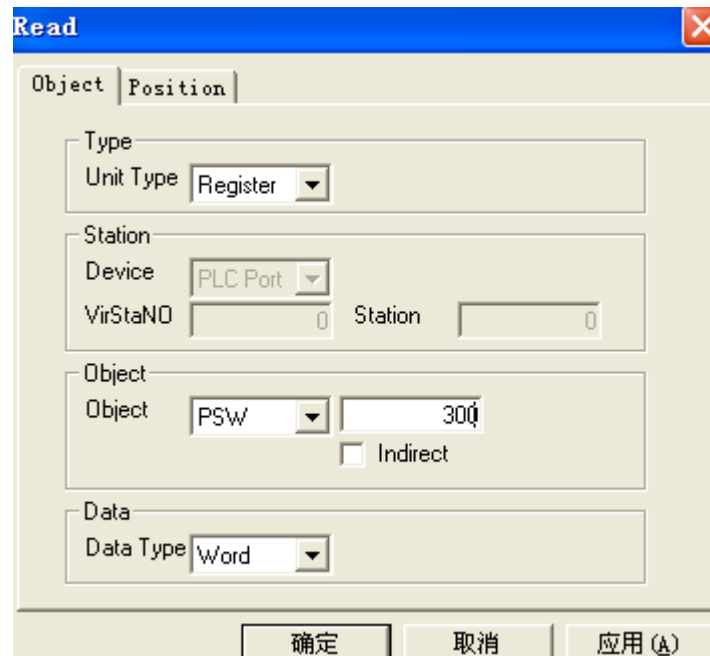

e. Double-click the above “Write” component , open the Properties dialog box , set **Unit Type** as  , **Object** set to PSW300,as follows:

Type	Unit Type Register	
Station	Device PLC Port	
	VirStaNO <input type="text" value="0"/>	Station <input type="text" value="0"/>
Object	Object PSW <input type="text" value="300"/>	
	<input type="checkbox"/> Indirect	

f. Double-click Arithmetic  component, open the Properties dialog box , set **Right Operand** of **Value** to 1. as follows:

Arithmetic	
Rule Operation	Position
Kind Plus (+)	
Left Operand	Right Operand
Type Dec	Type Dec
Value <input type="text" value="0"/>	Value <input type="text" value="1"/>
<input type="button" value="确定"/> <input type="button" value="取消"/> <input type="button" value="应用 (A)"/>	

g. Double-click the following component “READ”, open the Properties dialog box , set **Unit Type** as **Register** , **Object** set to PSW300,as follows:

Type	Unit Type Register	
Station	Device PLC Port	
	VirStaNO <input type="text" value="0"/>	Station <input type="text" value="0"/>
Object	Object PSW <input type="text" value="300"/>	
	<input type="checkbox"/> Indirect	



h. Double-click the following component “Write”, open the Properties dialog box , set **Unit Type** as **Register** , **Object** set to PSW300, **Set Data** set to 0,as follows:

Type	
Unit Type	Register
Station	
Device	PLC Port
VirStaNO	Station
Object	
Object	PSW 300
<input type="checkbox"/> Indirect	
Data	
Data Type	Word
Set Data	0

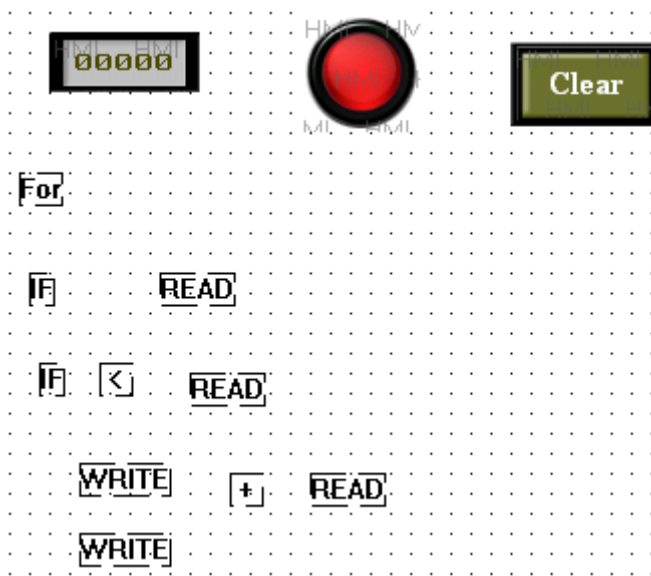
i. Property set belonging to these parts are completed, the final results are as follows:



Step3: Advanced Operations

1. Select two IF、three Read、two Write、one  、one  at the same time, Right-click the selected area, choose Advanced ,as follows:

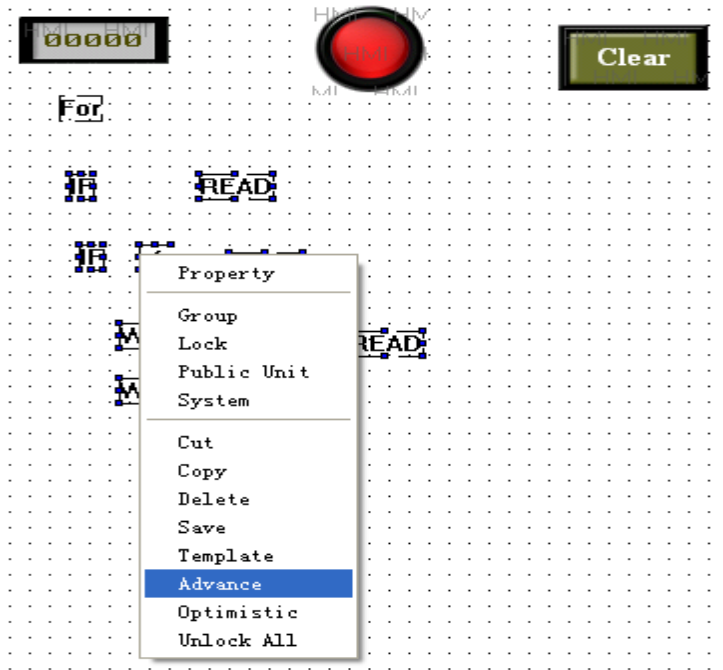

2. Pop-up the following advanced dialog box:

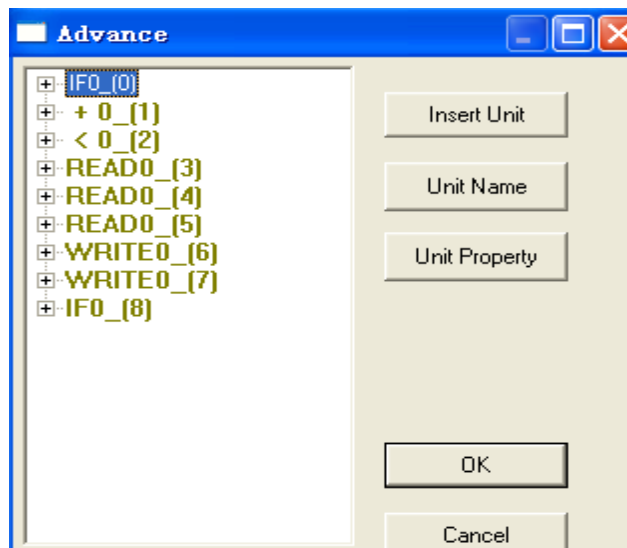

3. Click the small plus sign \oplus in front of directive `IFO (0)` , Successively click the front plus sign \oplus , open `IFO (0)` directive's self property, then select "current value", as follows:

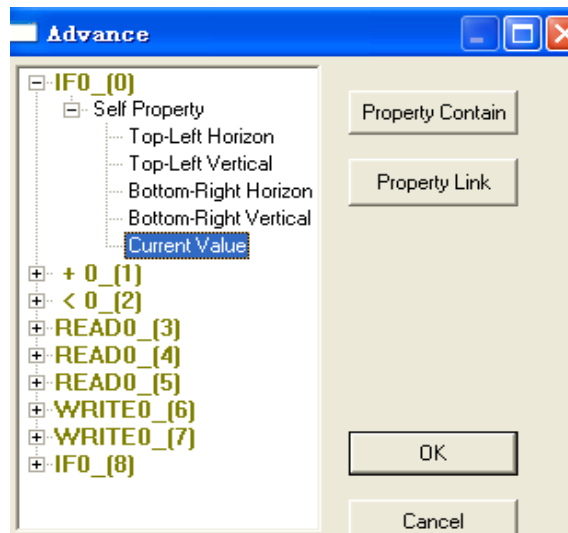

4. Click the right button **Property Contain** in the dialog box, the button will be grayed-out non-operational status, while text changed into “affirm contain”, as follows:

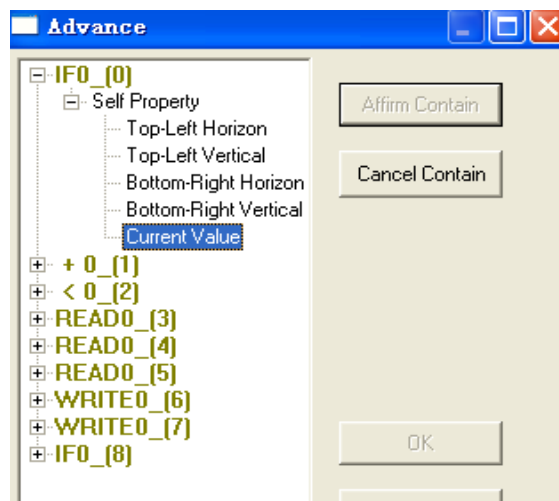

5. Select **READ0 [3]**, button **Affirm Contain** immediately changed into operational status, as follows:

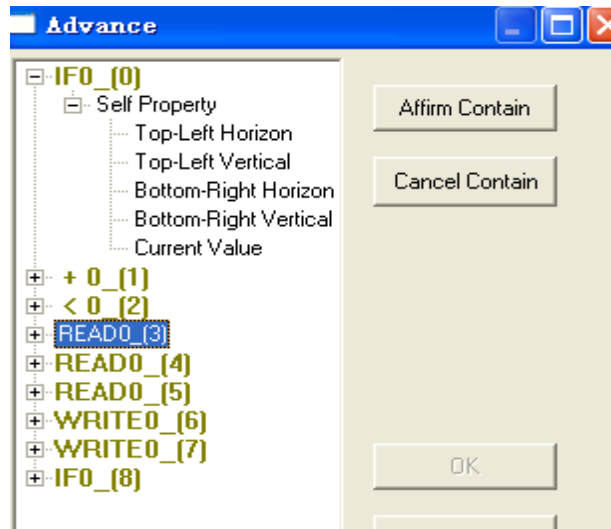

6. Click **Affirm Contain** button, complete **IFO(0)** directive's Component contain, select **IFO_(8)**, as follows:

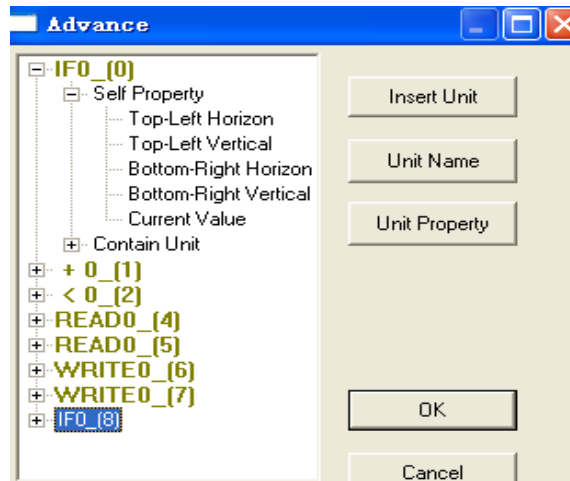

7. Click the right button **Insert Unit** in the dialog box, the button will be grayed-out non-operational status, while text changed into "affirm insert", as follows:

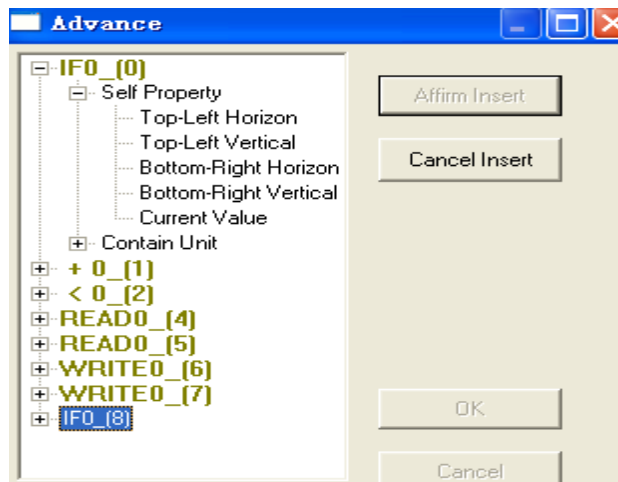

8. Select **IFO_(0)**, button immediately changed into operational status , as follows:

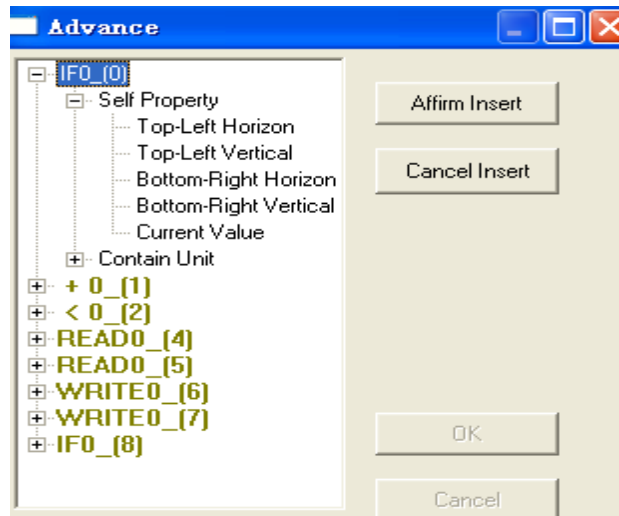

9. Click **Affirm Insert** button, complete **IFO_(0)**. Component insertion. click the plus sign **+** in front of self property of **IFO_(0)**,open the self property of **+** **IFO_(8)**,select “current value”, as follows:

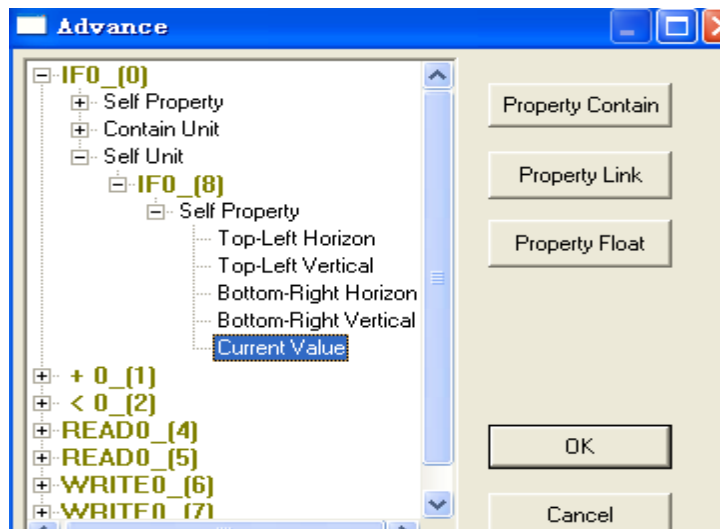

10. Click the right button **Property Contain** in the dialog box, the button will be grayed-out non-operational status, while text changed into “affirm contain”, as follows:

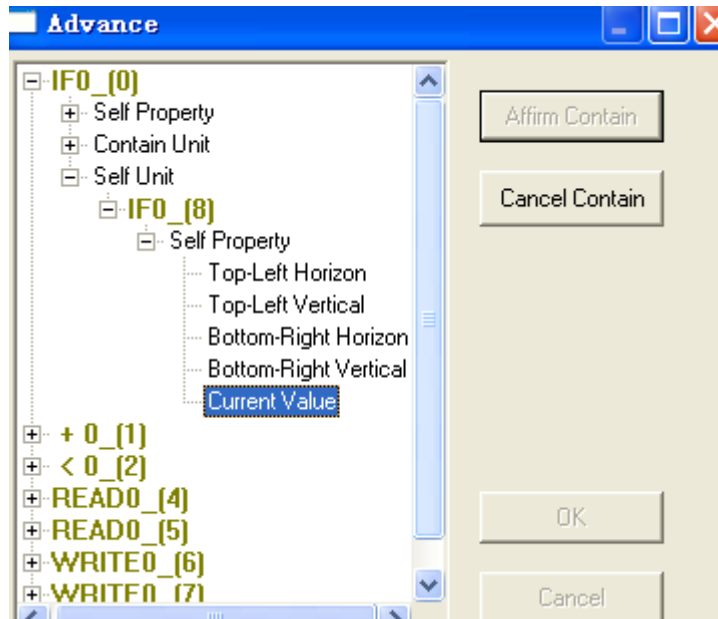

11. Select \oplus **< 0_2** , button  immediately changed into operational status , as follows:

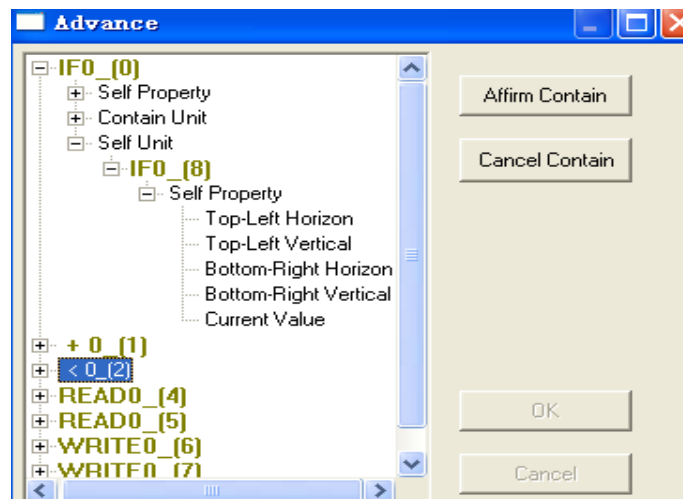

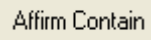
12. Click  button, complete \oplus **IFO_8** Component contain. click the plus sign \oplus in front of property of \oplus **IFO_8** ,successively open the self property of \oplus **IFO_8** ,select “left operand”, as follows:

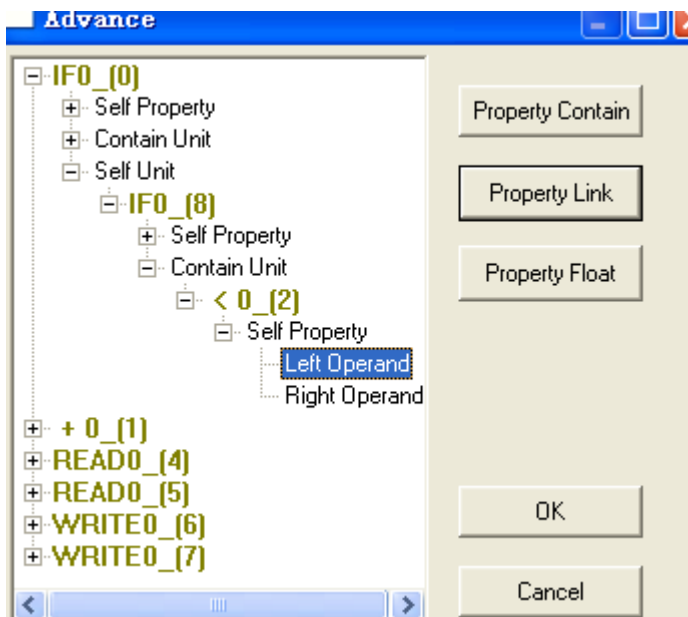

13. Click the right button **Property Contain** in the dialog box, the button will be grayed-out non-operational status, while text changed into “affirm contain”, as follows:

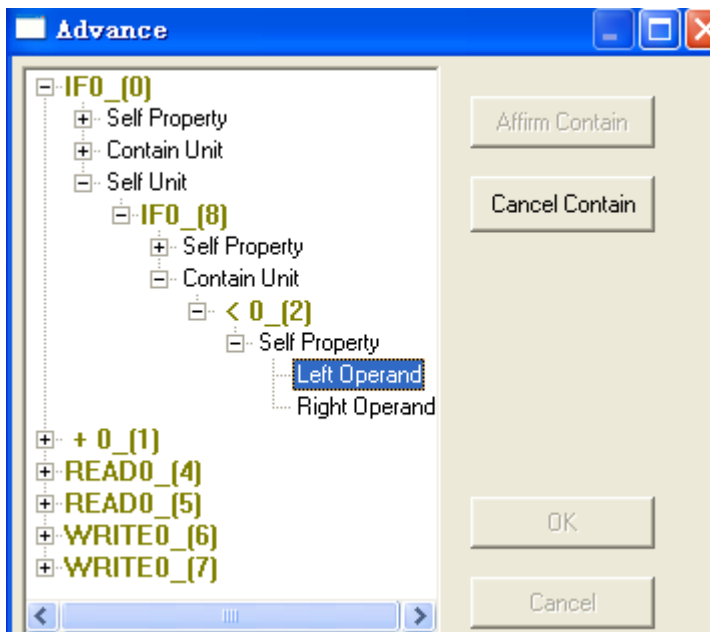

14. Select **READ0_ (4)**, button **Affirm Contain** immediately changed into operational status , as follows:

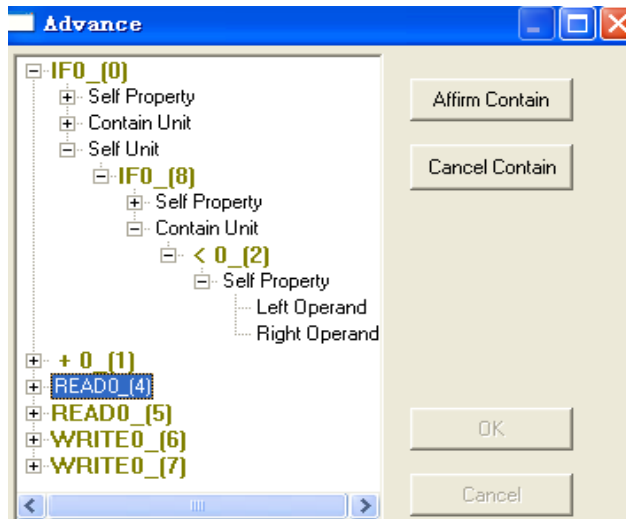

15. Click button , complete < 0_2 Component contain. Select “ WRITE0_6” as follows:

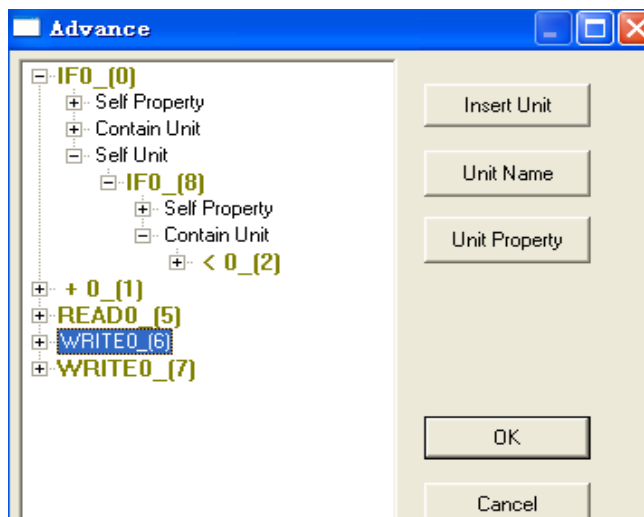

16 Click the right button in the dialog box, the button will be grayed-out non-operational status, while text changed into “affirm insert”, as follows:

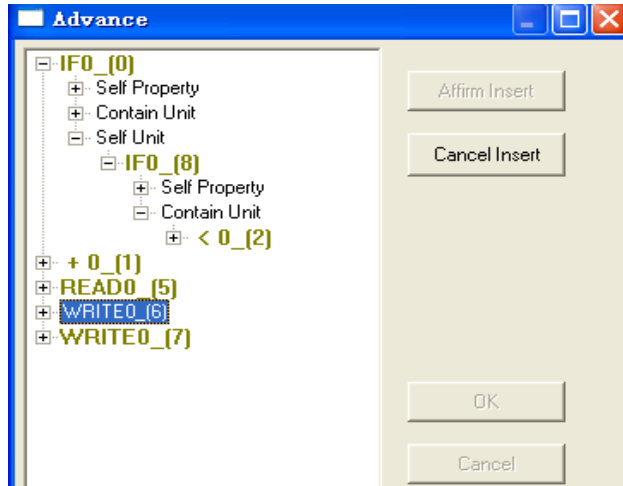

17. Select **IF0_8**, button immediately changed into operational status, as follows:

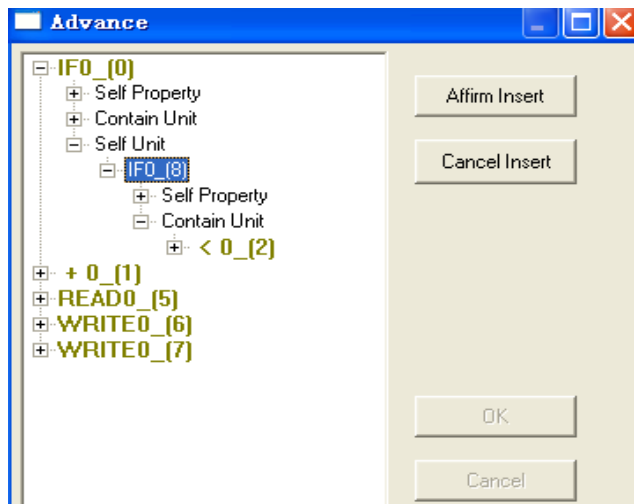

18. Click **Affirm Contain** button, complete **IF0_8** Component contain. click the plus sign **+**

in front of property of **WRITE0_6**, select "Input Value", as follows:

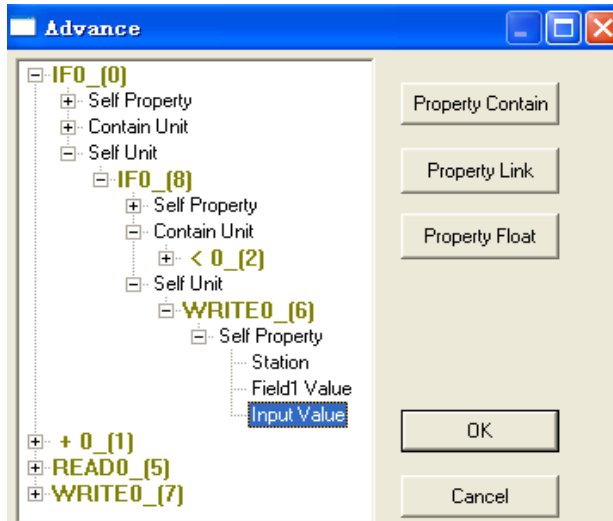

19. Click the right button **Property Contain** in the dialog box, the button will be grayed-out non-operational status, while text changed into “affirm contain”, as follows:

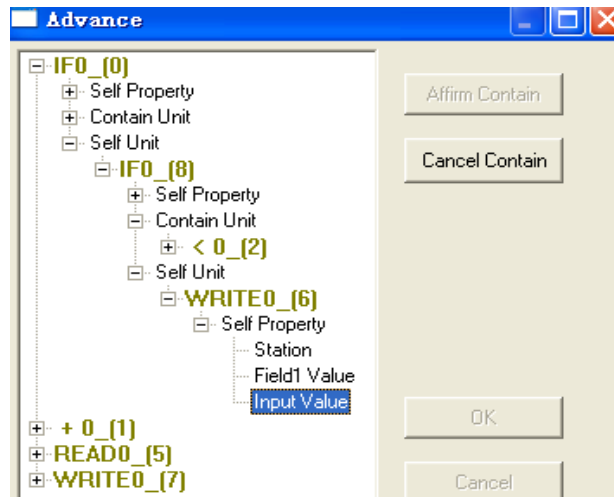

20. Select **+ 0_1**, button **Affirm Contain** immediately changed into operational status, as follows:

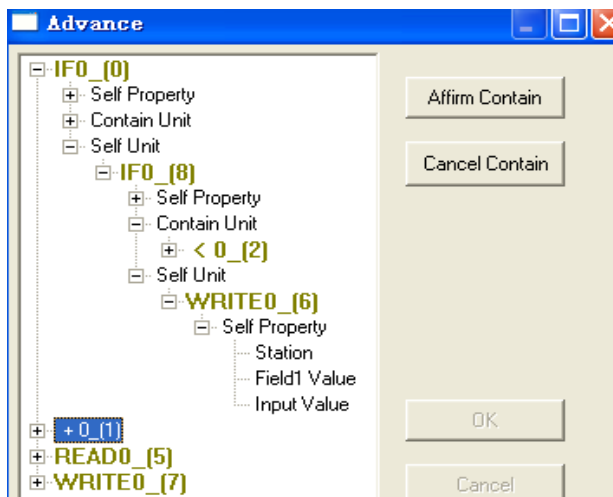

21. Click **Affirm Contain** button, complete **WRITE0_6** Component contain. click the plus sign **+** in front of property of **WRITE0_6**, successively open the self property of **+ 0_1**, select “**Left Operand**”, as follows:

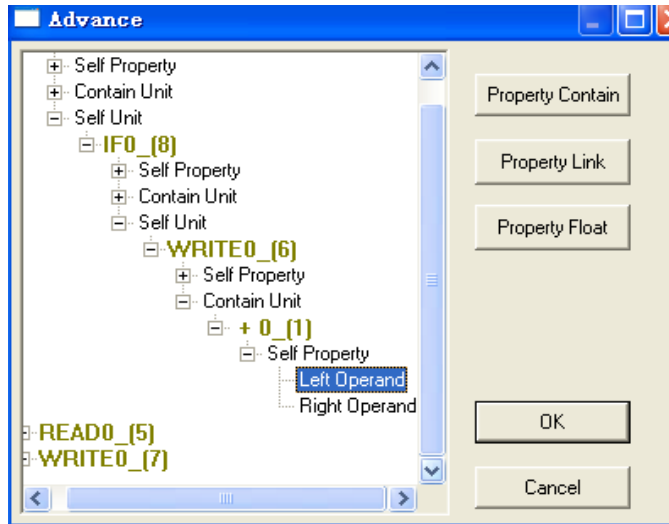

22. Click the right button **Property Contain** in the dialog box, the button will be grayed-out non-operational status, while text changed into “affirm contain”, as follows:

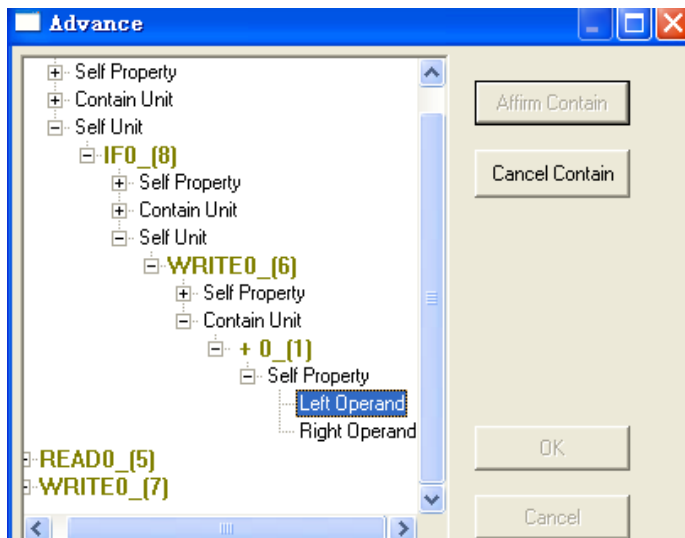

23. Select **READ0_5**, button **Affirm Contain** immediately changed into operational status, as follows:

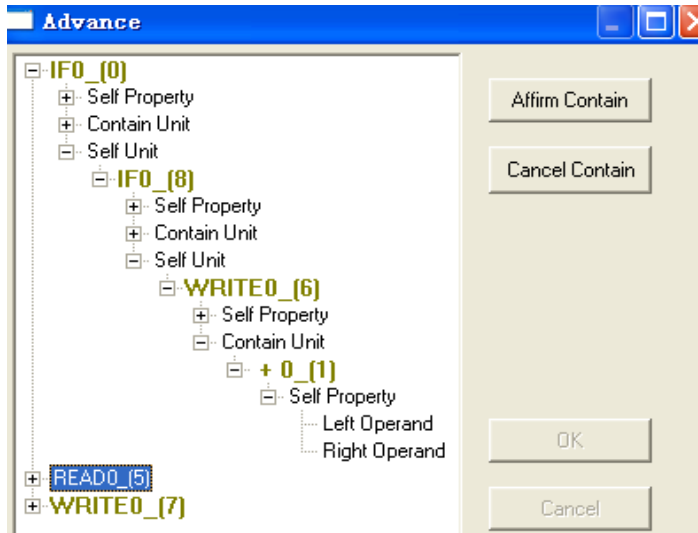

24. Click **Affirm Contain** button , complete **IF0_8 + 0_1** Component contain 。 select **WRITE0_7** , as follows:

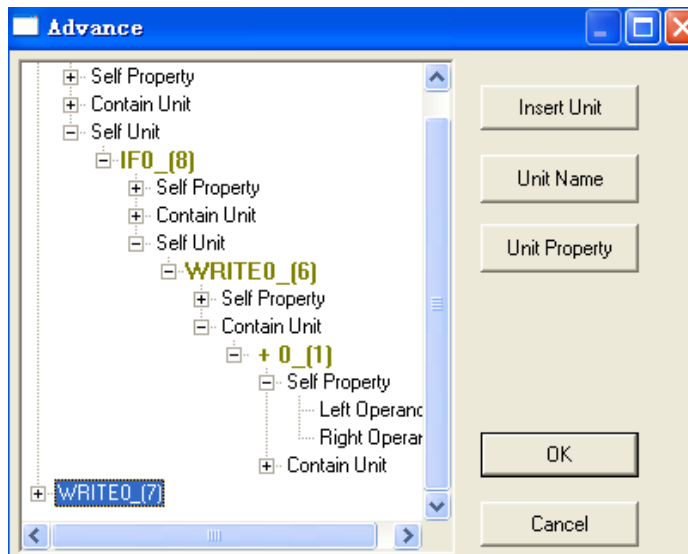

25. Click the right button **Insert Unit** in the dialog box, the button will be grayed-out non-operational status, while text changed into “affirm insert”, as follows:

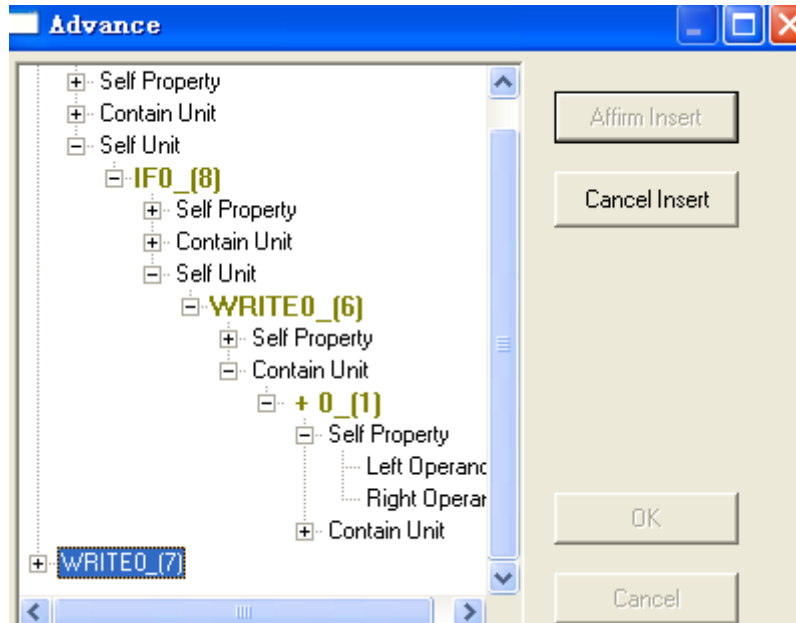

26. Select **IFO [8]** , button immediately changed into operational status , as follows:

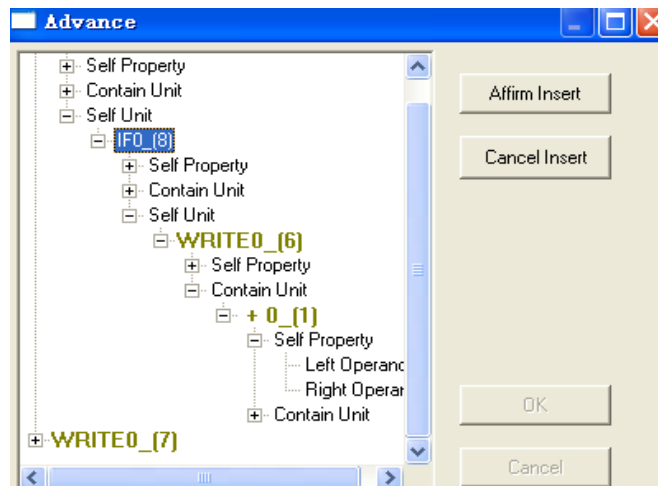

27. Click **Affirm Insert** button, complete **IFO [8]** Component insertion.

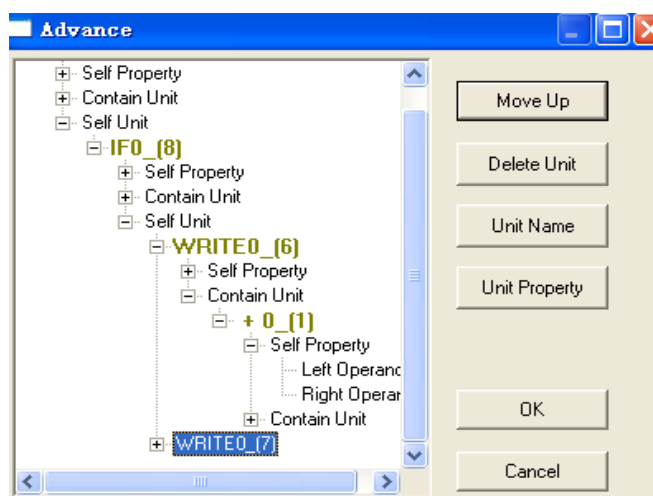

28. Finally click  button, Advanced operations are completed. The final screen effects are shown below:

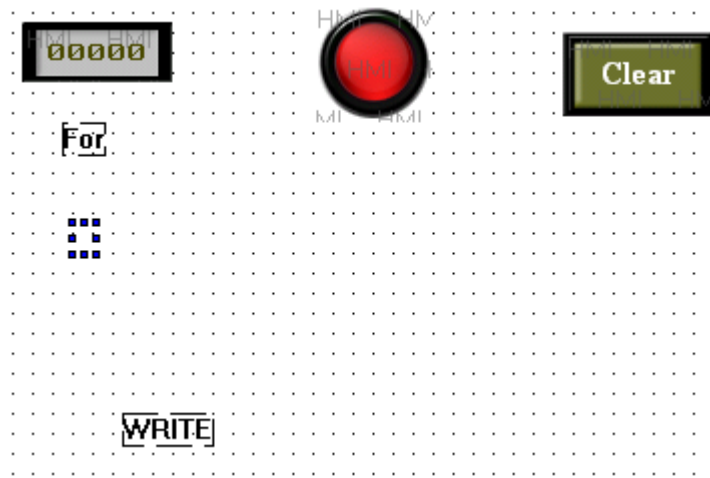

29. Click the “off-line simulation” icon on the software , See the following simulation results:



5. Advanced functions integrated application

5.1 Register over the value of cleared

- **Overview**

When the value of register exceeds upper limit value, cleared the register or set to other values. Here we use PFW300 as an example, when the value of PFW300 exceeds 16 , cleared PFW300.

- **Routine**

Step 1: Building a screen, placing parts

Building a new screen, placing the following components: one “If” component, one “compare” component, one “read” and one “write” component.

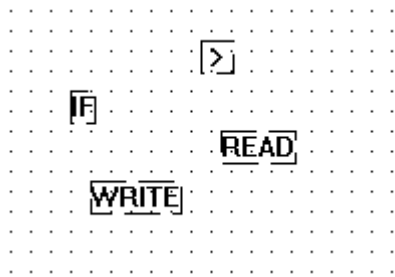

Step 2: Double-click “Read” , point object to PFW300; Double-click “compare” component, choose kind as $>$, set right operate as 16.

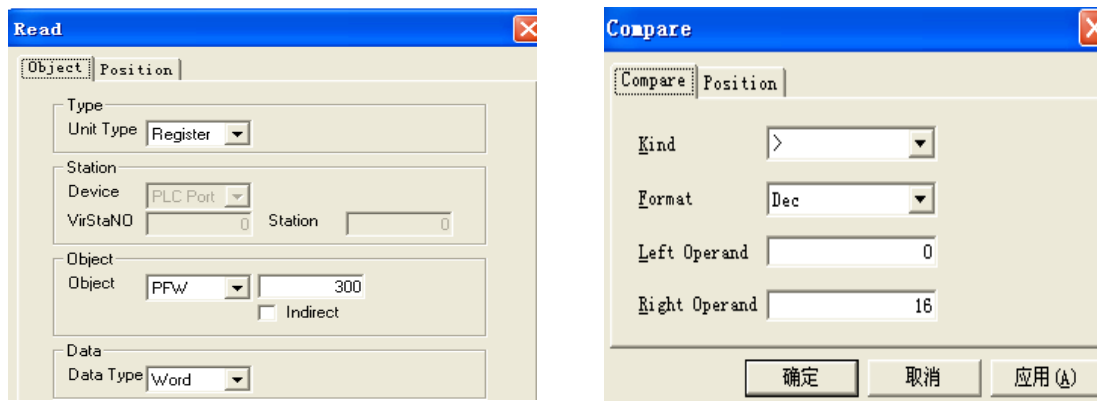

Step 3: Box selecting “compare” and “Read”, Right-click the selected area, choose Advanced, Pop-up the following advanced dialog box:

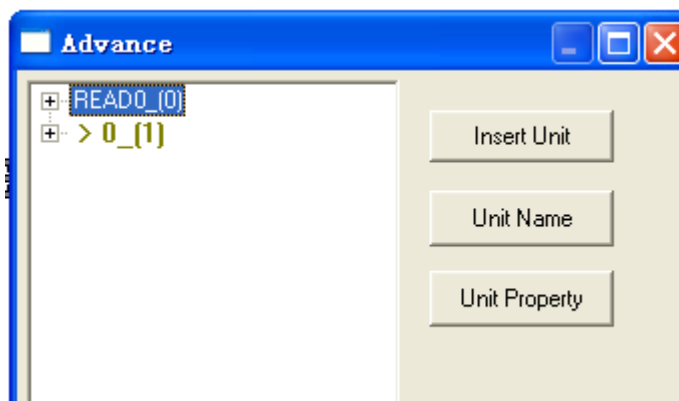

Step 4: Click Left operate of $> 0_(1)$ → click “property contain” → choose $> 0_(1)$ → click Affirm Contain .

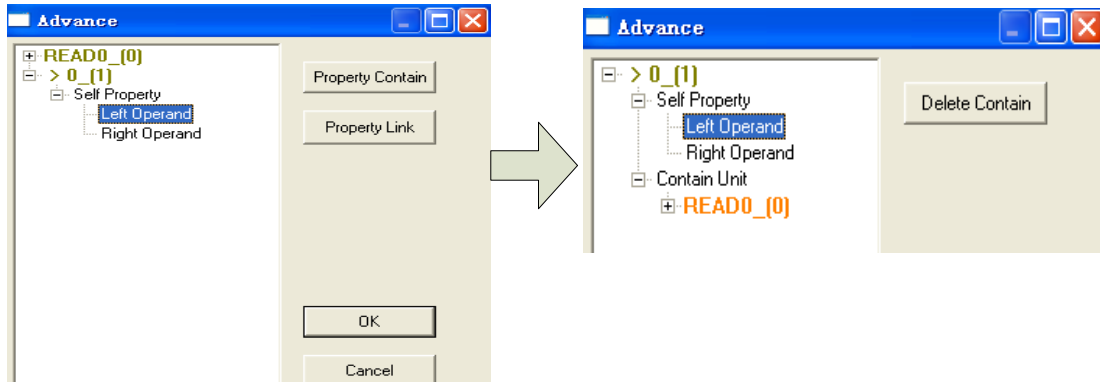

Step 5: Box selecting “compare” component and “If”, Right-click the selected area, choose Advanced, with the same operations, **Current Value** of If component property contain **> 0_(1)** :

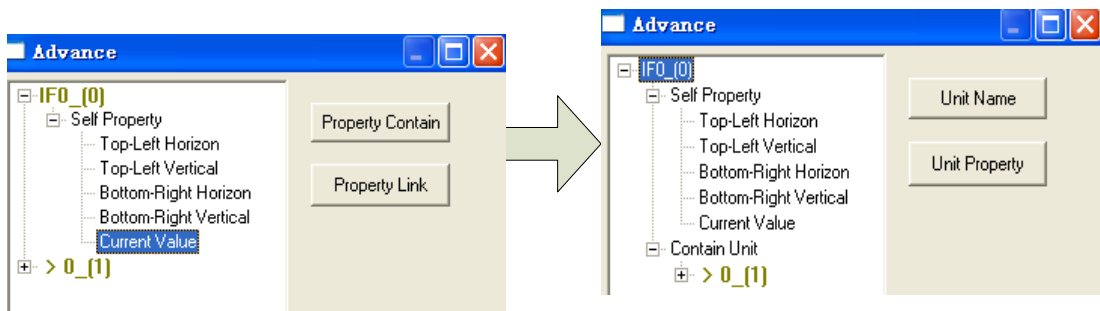

Step 6: Double-click “Write”, open the Properties dialog box, in **Object** option , modify object to PFW300, set data as 0, as follows:

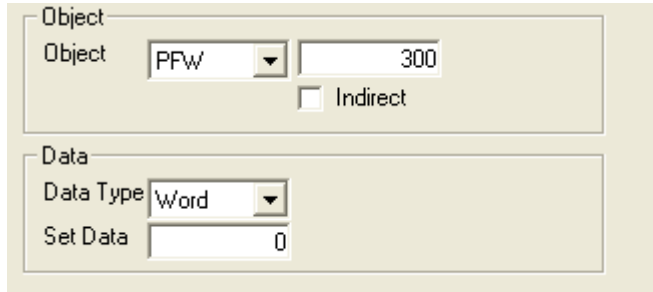

Step 7: Drag “write” into “If” , will pop-up “Are you sure add selected unit to alter?” ,select “Yes”, add “write” into “If” component’s self unit.

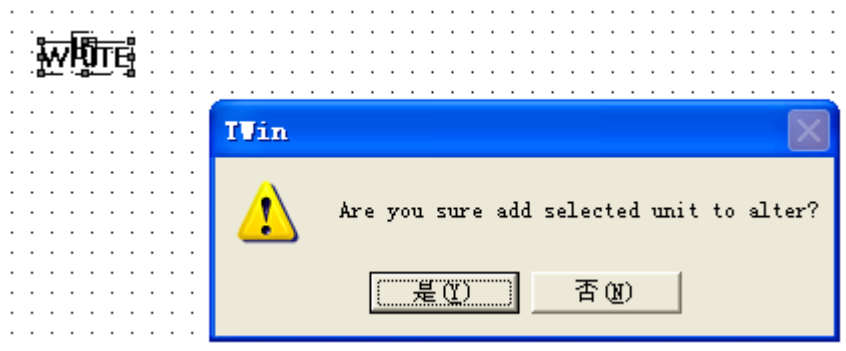

Step 8: Put one digital input  on the screen, modify object to PFW300.



Finally, the production of functional components has been finished. When you enter one data exceeds 16, it will be automatically cleared.

5.2 Three-position switch

• Overview

Here we learn how to make a three-position switch on Thinget touch screen, what does three-position switch mean? For example: Fan stall selection, rotating a switch, you can select a file wind, two stalls wind, can also choose to stop. Here, we need to make a switch. As shown below:



If the initial position is in manual state, this time M0 Set, M1, M2 reset, click on the touched area first time, the switch will be in off state, this time M1 set, M0, M2 reset; clicking the touched area second time, the switch will turn to automatic state from off state, then M2 set, M0, M1 reset. Such as the cycle.

• Routine

Before building advanced function, we have to sort our ideas basing on the function we want.

Step 1: switch pictures

(1) because we need to switch the three kinds of pictures, so it would be best to use the value of registers to switch pictures. (As an example, here we use the register PFW300 which the value can be saved when power-down).

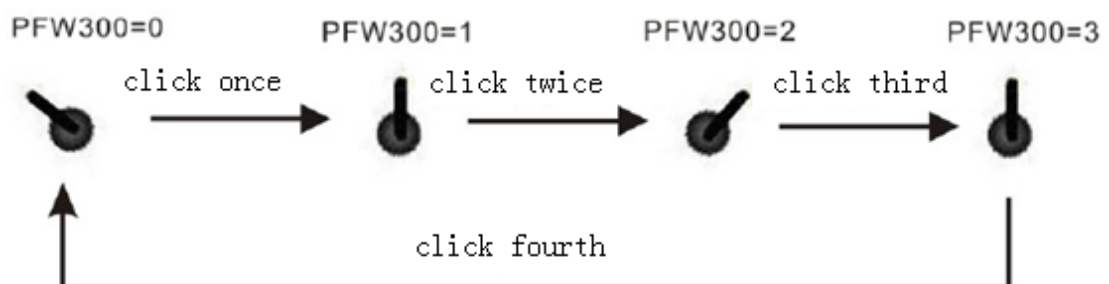

(2) On the touch screen, use the “Insert picture” function, insert the following four pictures. This represents several states of a button.

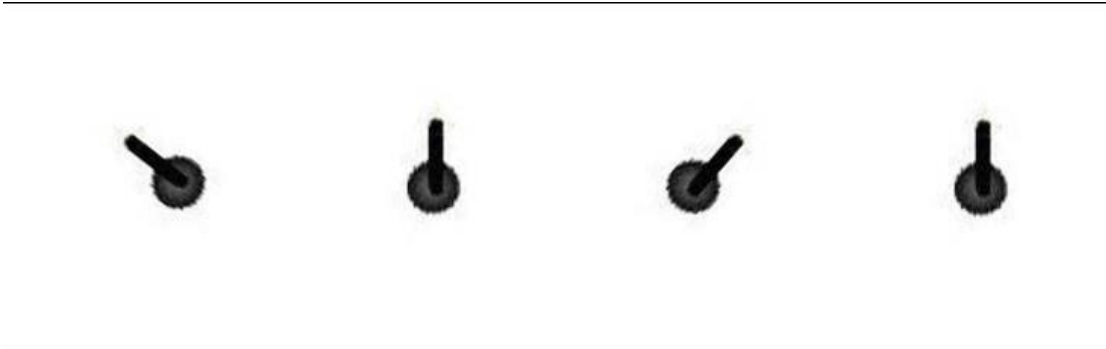

(3) Put four pictures together.



(4) Place one “Switch” part and one “READ” part on the screen.



(5) Double-click the Read part, in the dialog box, modify the object types as PFW300, clicking OK to return.



(6) Box select “Switch” and “READ” two parts, right-click, in the pop-up menu, select “advanced”

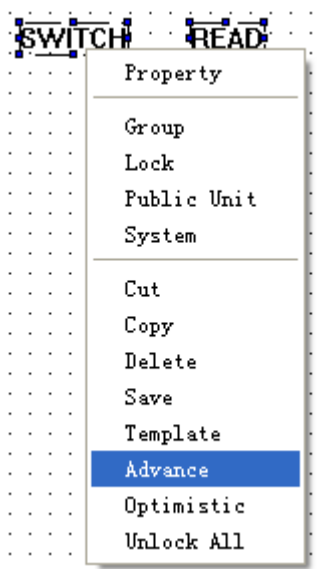

(7)The Switch part of the “current index” property contain “READ”part. After property contain, results are as follows, click OK to exit.

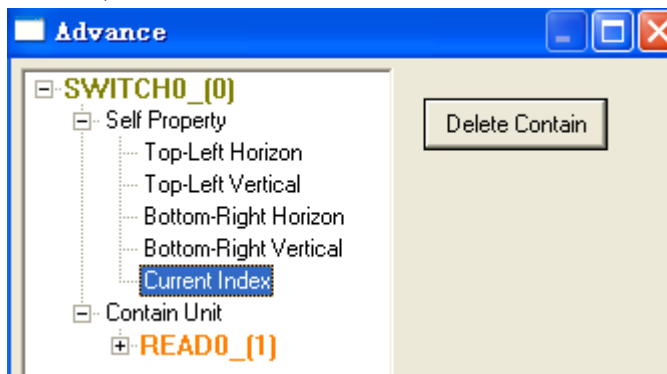

(8) Put the part and just mentioned four pictures together, then box select them.

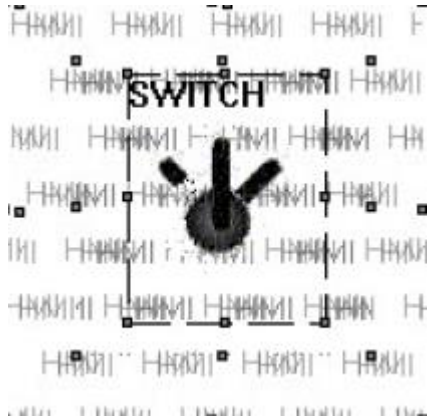

(9) After box selecting, right-click then in pop-up menu, select “Advanced”, Inset the four pictures into “Switch” part one by one.

(10) Through move up and move down to change position of pictures. (Note: in self unit, while the top picture value is 0, it shows, those underling represent value of 1, 2, 3)

Step2: Put one “function Button” on the screen, In the button option, check Hide Button, The “function Button” to implement the operation of PFW300 self plus one.

(1) Add “function Button” on the screen,

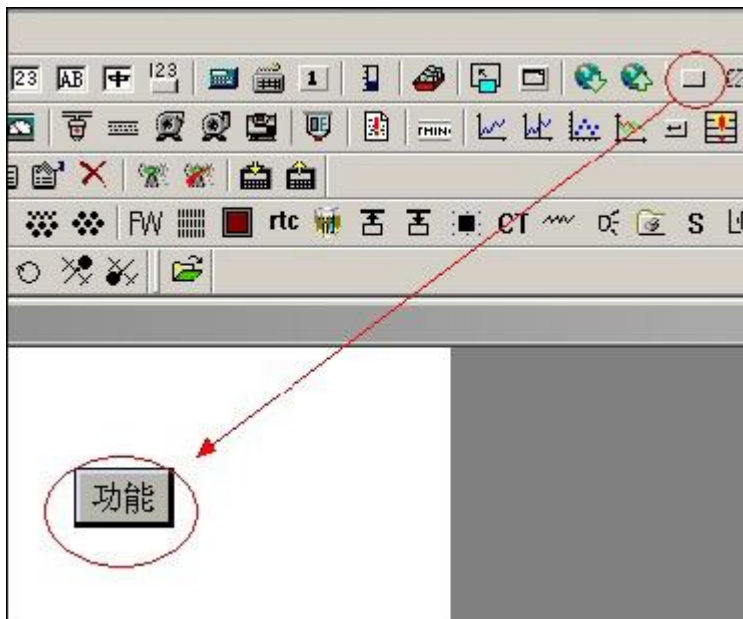

(2) Double-click “function Button”, set the function as “PFW300=PFW300+1”, as shown below:

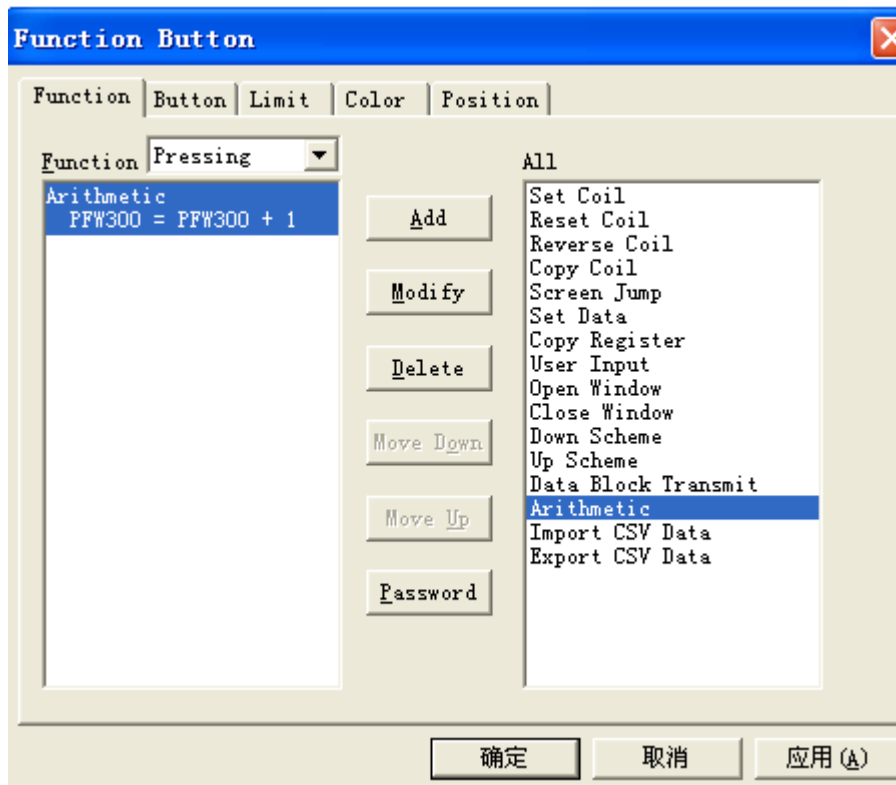

(3) Select “button” option, check Hide Button.

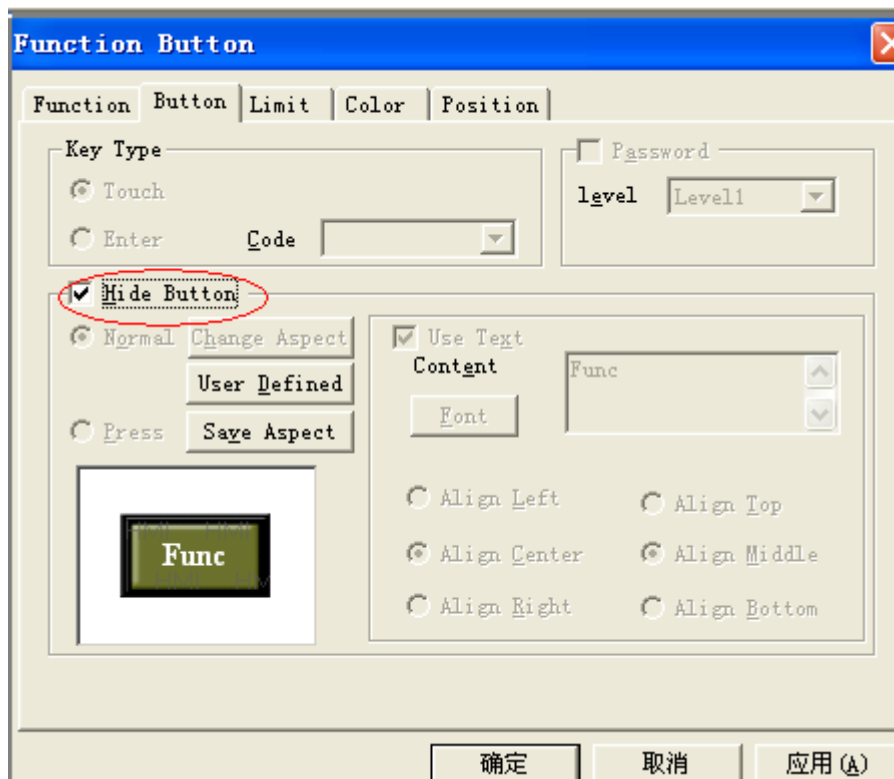

(4) Then, move the hide function key to the picture which created in the previous step.



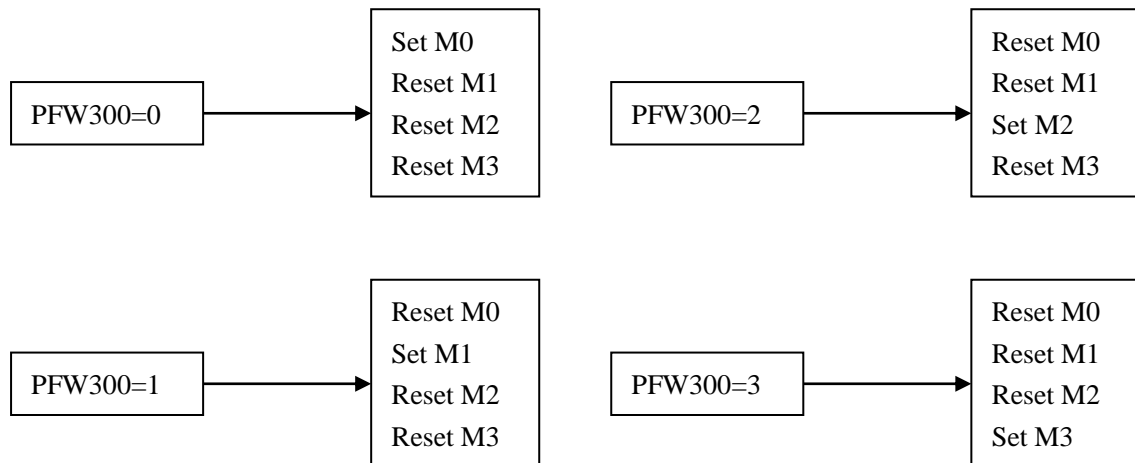

Step3: control coil output

(1) We not only need picture display, but also output of function coil, pictures in the different state can output different coils, it also means that output different coils under the different value of register .

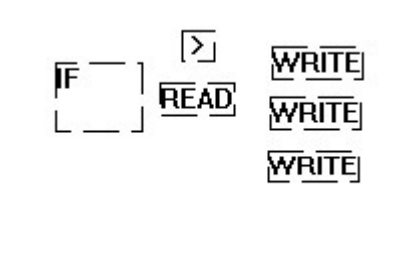

(2) In order to achieve the above purpose, need to use "IF", "Read", "Write", "comparison" parts, Here began to make coil output command. in case of PFW300 = 0.



(3) Double-click "comparison" part, set compare kind as  , as the following figure:

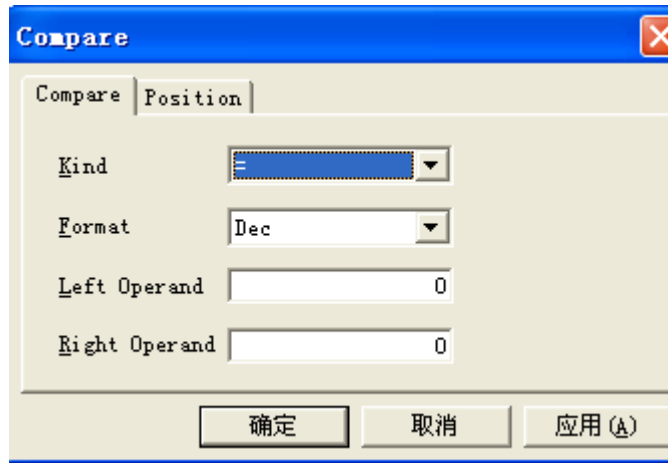

(4) Double-click “Read”, open the Properties dialog box, in **Object** option , modify object to PFW300, as follows:



(5) Box selecting “Read” and “comparison” parts, Right-click the selected area, In the Pop-up dialog box , the left operand of “compare” attribute contain the “Read”, click “OK” to quit :

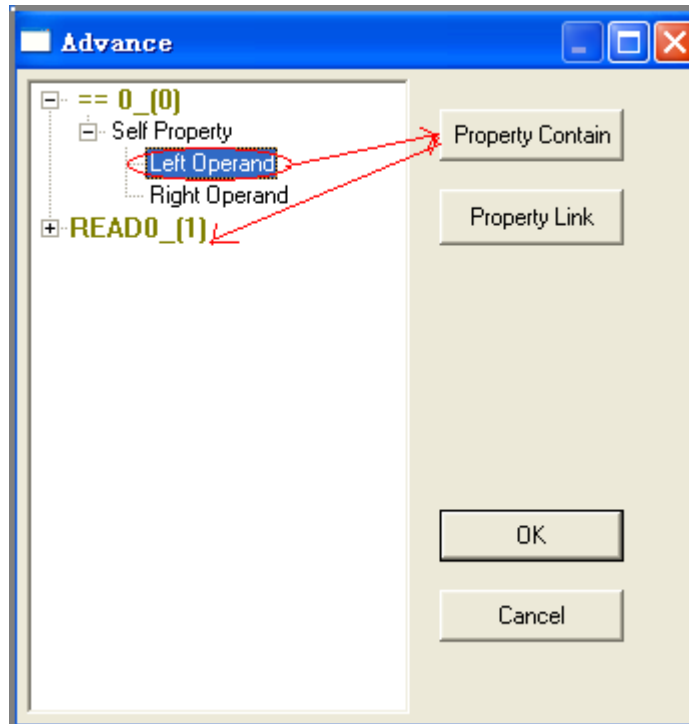

(6) Box selecting the contained “compare” and “If” components, Right-click the selected area, In the Pop-up dialog box , the current index of “If” attribute contain “compare”, click “OK” to quit:

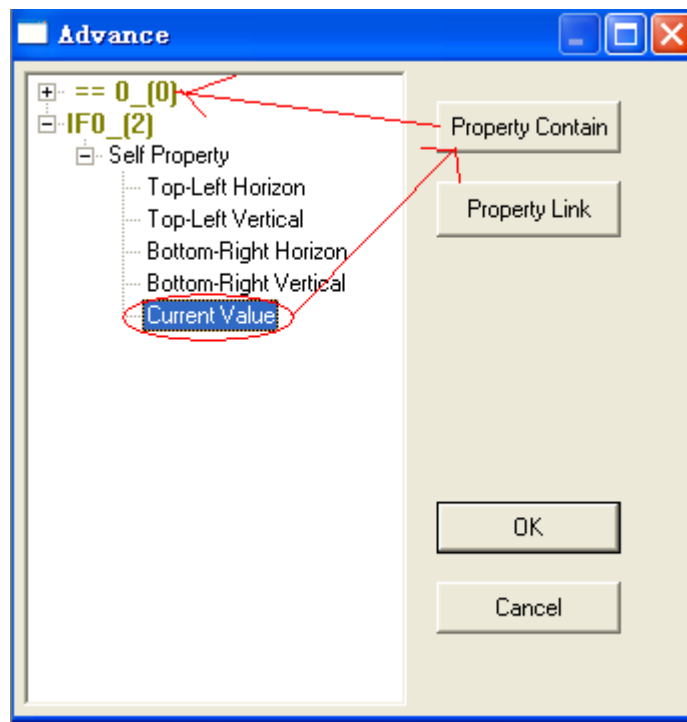

(7) Double-click the first “Write”, open the Properties dialog box, point object to M0, modify **Set Data** as 1, as follows:

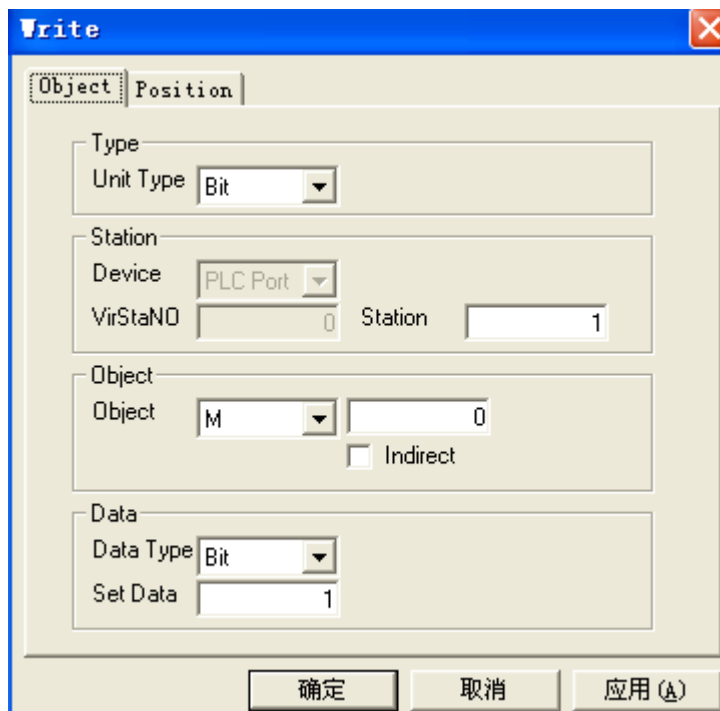

(8) Double-click the second “Write”, point object to M1, modify **Set Data** as 0, Double-click the third “Write”, point object to M2, modify **Set Data** as 0. box select them , right-click the selected area, In the pop-up menu, select “combination”, as follows:

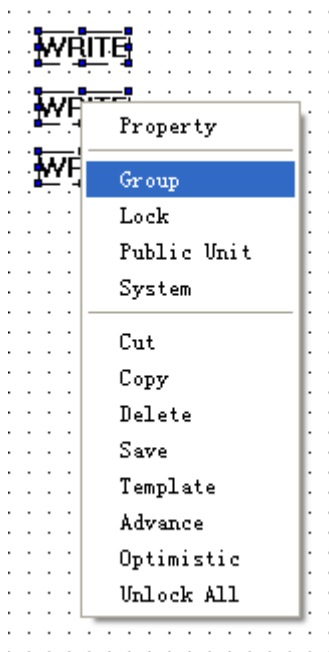

(9) After the combination of the three "Write" parts , move the combination to the “IF” part which has been produced in above step , will pop-up “Are you sure add selected unit to alter?”, Select “Yes”

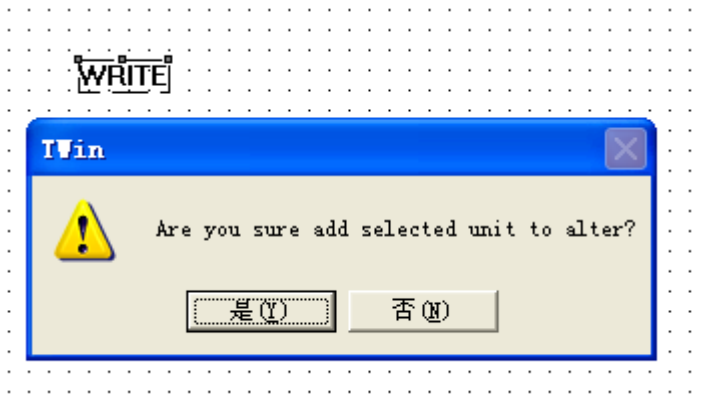

(10) With the same operation, produce the parts when PFW300 = 1, PFW300 = 2, PFW300 = 3 .

Step4: Use “exceed 16 return 0” approach of the first case, producing a part which PFW300 cleared when the value of PFW300 more than 3, At this point, the case production has been finished.

5.3 Button interlock

• **Overview**

In the engineering screen editing process, often used “Button interlock” function. Its specific application is as follows:

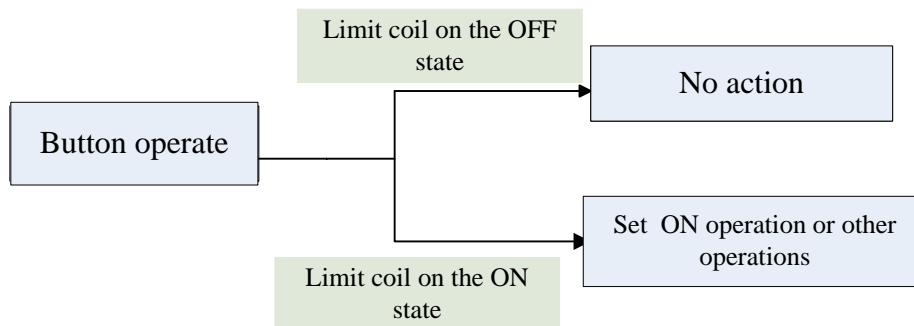

The following would be examples of “button interlock” function of the specific application, as follows case, only when PSB401 in the ON state, the button PSB400 will take a counter-action operation.

Step1: building a screen, placing parts

Place two “text”,two “indicator” and two “button” on the screen, modify their properties:

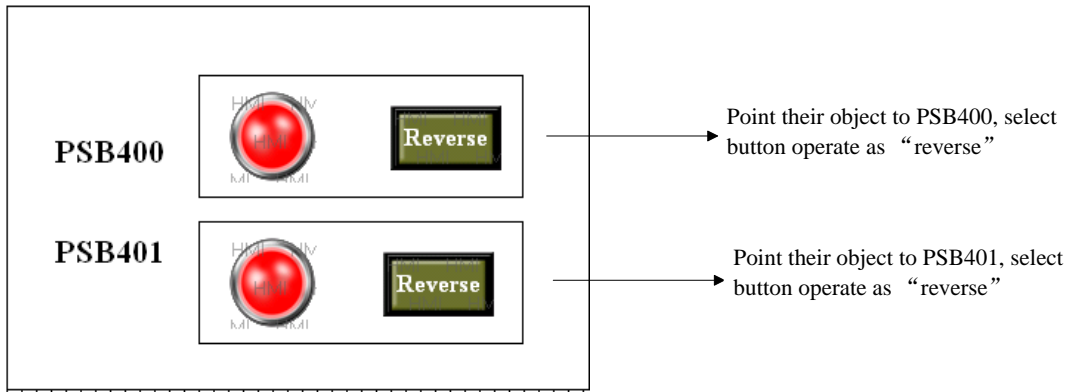

Step2: Put one “read” component on the screen as PSB400 button’s limit condition, point object to PSB401,as follows:

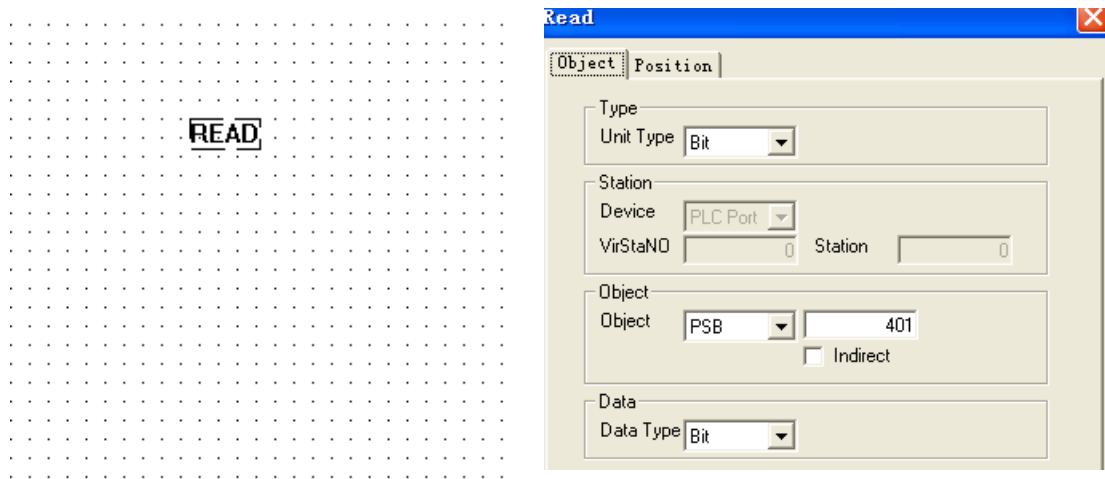

Remove PSB400 component’s contain unit “Password”, as follows:

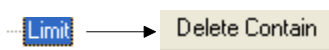
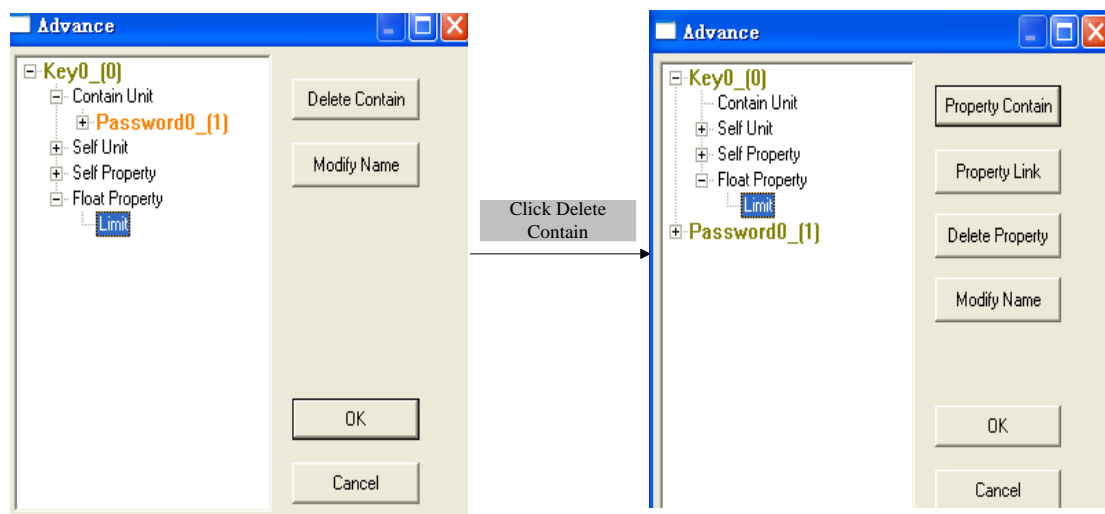

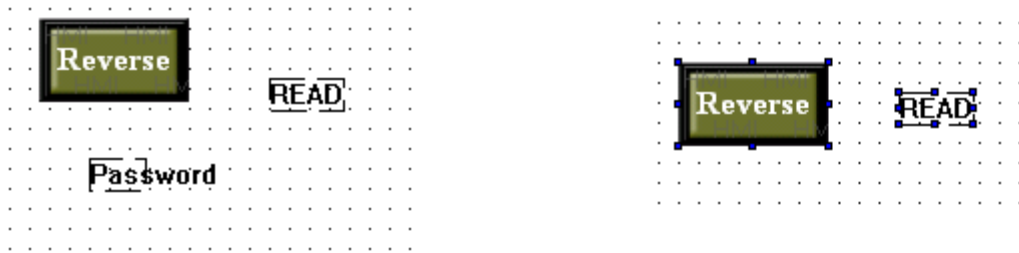

Delete “password”, select the button and “read” components

A

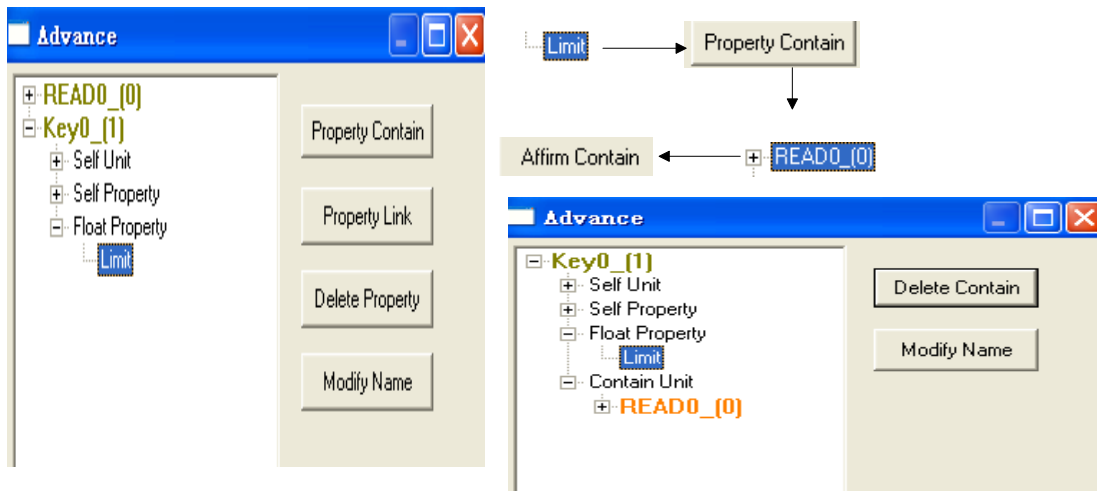

Add “read” as “Key” component’s contain unit, as follows:



Step3: Click the “off-line simulation” icon on the software , See the following simulation results:

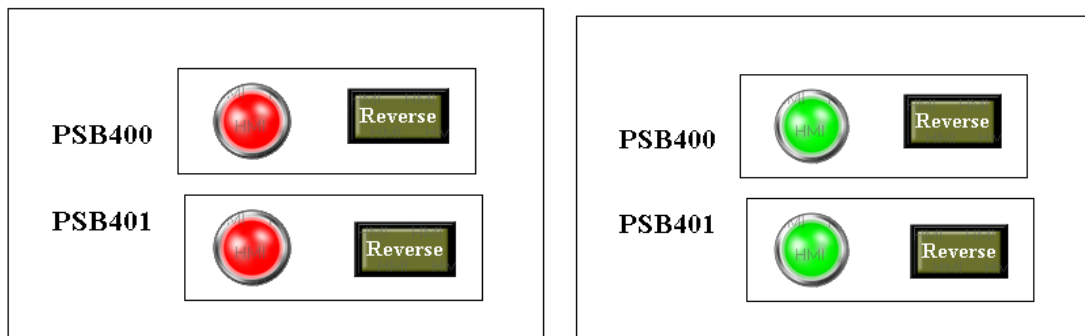

5.4 Coil control invisibility



- **Overview**

In practical application, some users often use the control signals to control operand's invisible or visible, that means when a control signal is ON, there will turn up a operating button, when the control signal is OFF, the operating button is invisible. To summarize this section, coil control invisibility can satisfy the functions which users ask for.

- **Routine**

Step1: Building a screen, placing parts

Building a new screen, placing the following components on the screen: two Indicator button

, one If , one , as follows:

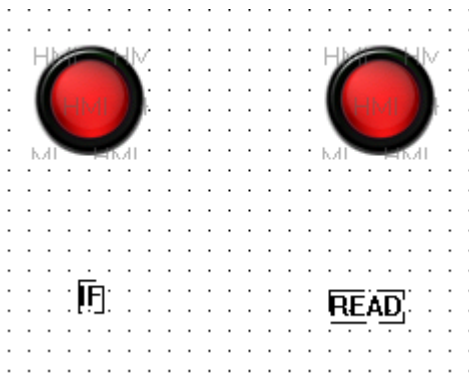

Step2: Modify properties

1. Double-click the left “Indicator button”, open the Properties dialog box, in **Object** option , modify object to PSB300, as follows:

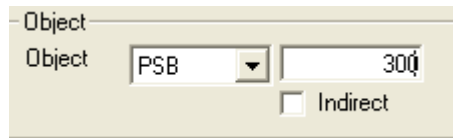

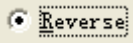
2. In **General** option, set button operate as , as follows:

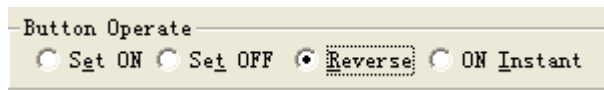

3. Double-click the right “Indicator button”, open the Properties dialog box, in **Object** option , modify object to PSB301, as follows:

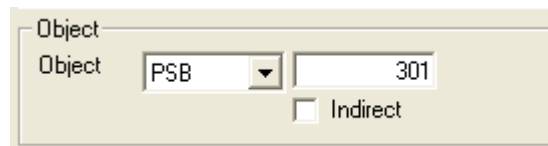

4. In **General** option, set button operate as , as follows:



5. Double-click “Read”, open the Properties dialog box , modify **Object** to PSB300, as follows:

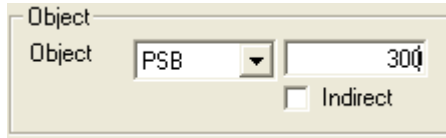

Step3: Advanced Operations

1. Select the right “Indicator button”, IF component and Read component at the same time, Right-click the selected area, choose Advanced, as follows:

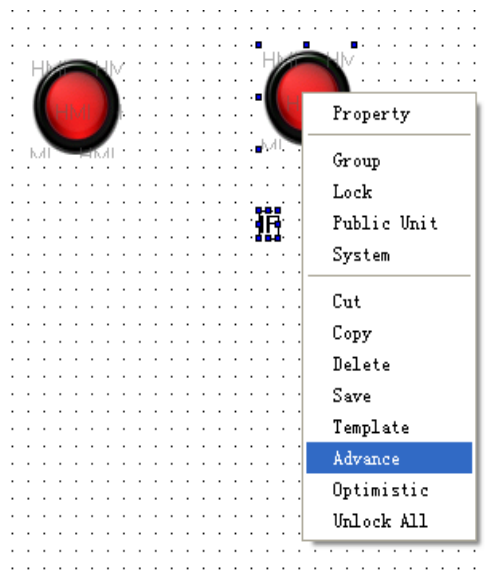

2. Pop-up the following advanced dialog box:

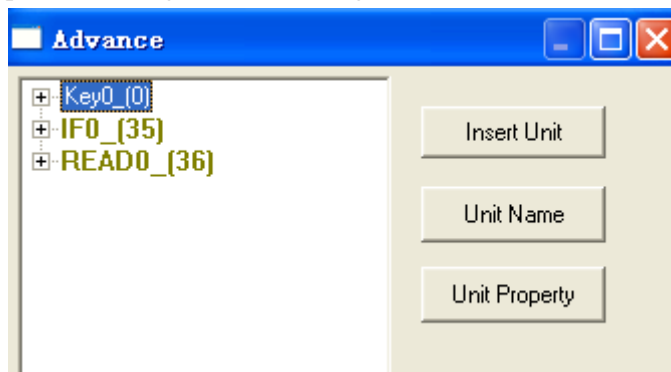

3. Select **+** **Key0_[0]** , Click the right button **Insert Unit** in the dialog box, the button will be grayed-out non-operational status, while text changed into “affirm insert”, as follows:



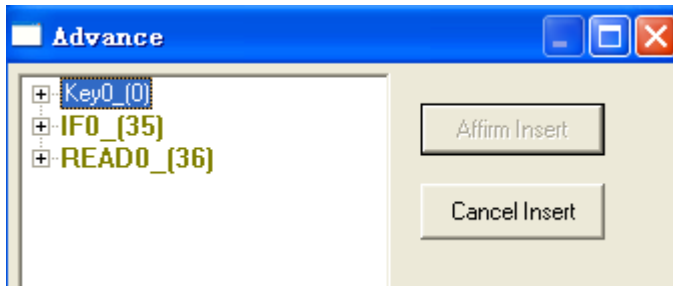

4. Select **+** **IFO_ [35]** , button immediately changed into operational status , as follows:

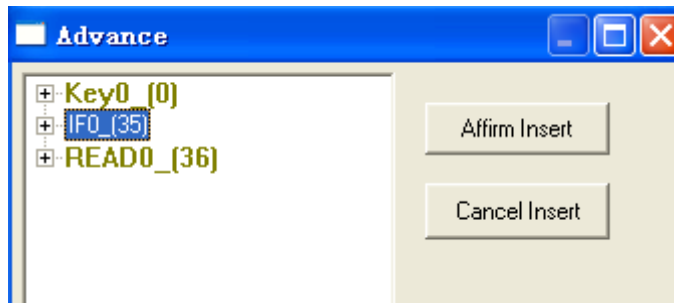

5. Click **Affirm Insert** button, complete **+** **Key0_ [0]** Component insertion. click the plus sign **+** in front of self property of **+** **IFO_ [35]** ,open the self property, select “current value”, as follows:

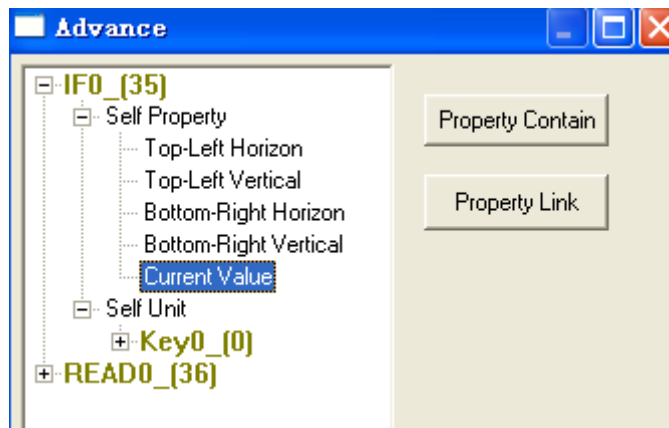

6. Click the right button **Property Contain** in the dialog box, the button will be grayed-out non-operational status, while text changed into “affirm contain”, as follows:

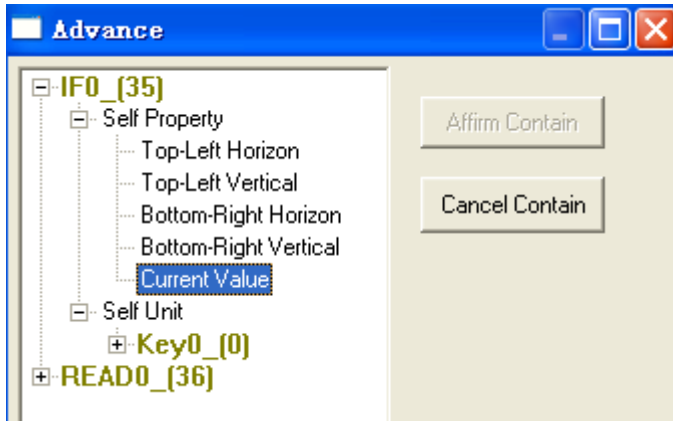

7. Select **READ0_[36]**, button **Affirm Contain** immediately changed into operational status, as follows:

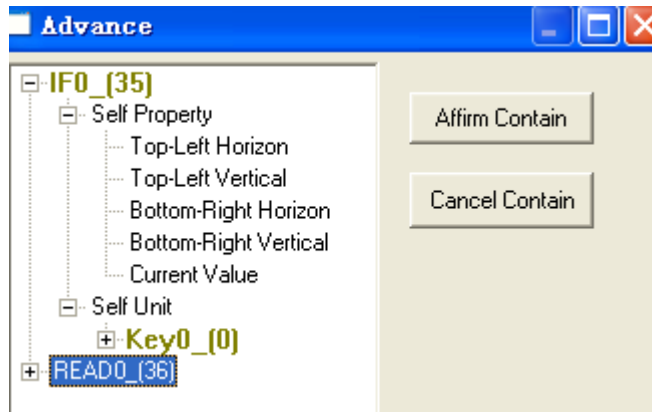

8. Click **Affirm Contain** button, complete **IFO_[35]** Component contain.

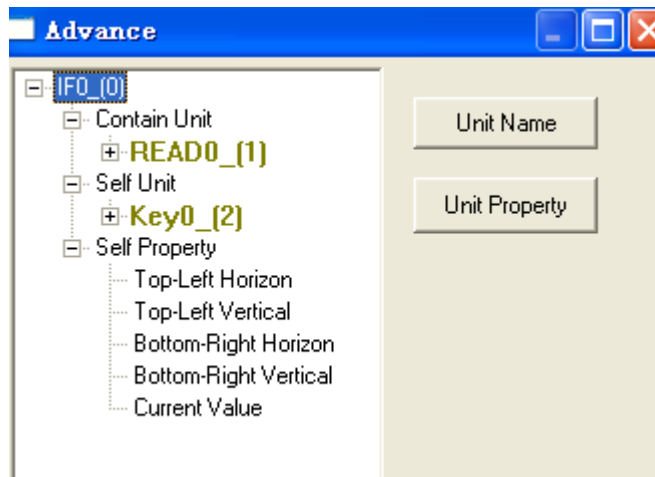

9. Finally click **OK** button, Advanced operations are completed. The final screen effects are shown below:



10. Click the “off-line simulation” icon on the software , See the following simulation results:





5.5 Color conversion of font

• Overview

In practical applications, in order to monitor the machine expediently, many customers use the change of control signal to change color of font on the current operation screen .This section will introduce how to change the current font’s color by modifying the data of register.

• Routine

Step1: building a screen, placing parts

Building a new screen, placing the following components on the screen: one text , one advanced instruction Read , one digital input , as the following diagram:

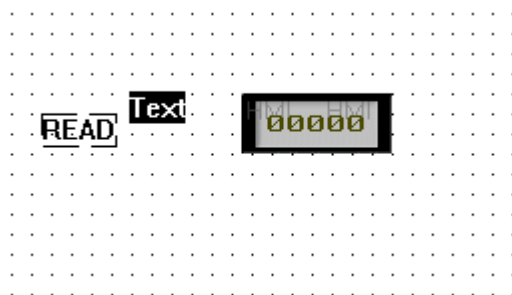

Step2: Basic components’ properties modification

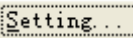
1.Double-click “text”, open the Properties dialog box, select  option, click  button.

2. Accordance with the above operation to set the font, then click **Color** option, In front of the transparent back remove the checkmark , Set the foreground color black, as follows:

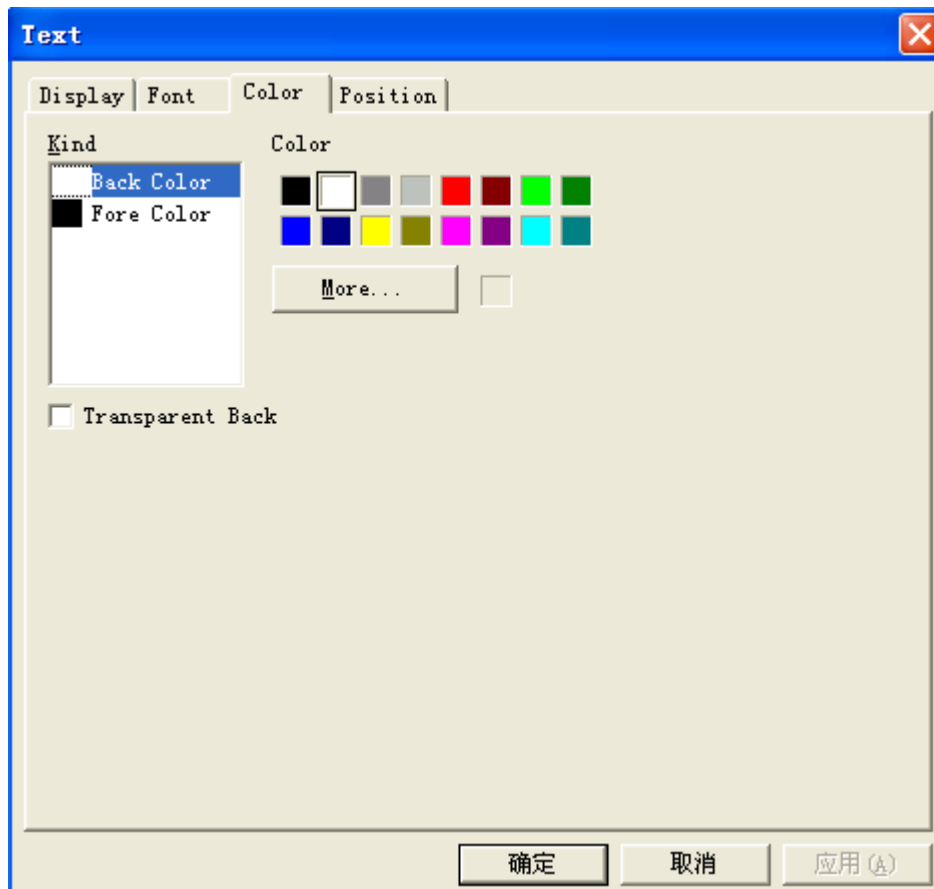

3. Double-click “Read”, open the Properties dialog box, here the modify type is register; object is PSW300, as follows:

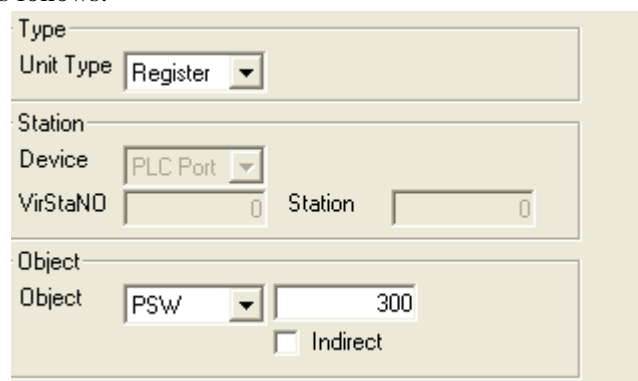

4. Double-click “Digital input”, open the Properties dialog box, point object to PSW300, as follows:

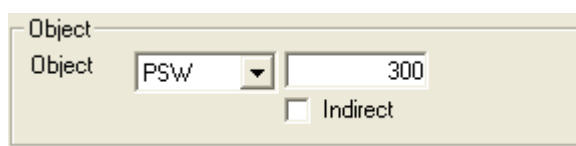

5. Completion of all the attributes modification, the final picture is as follows:

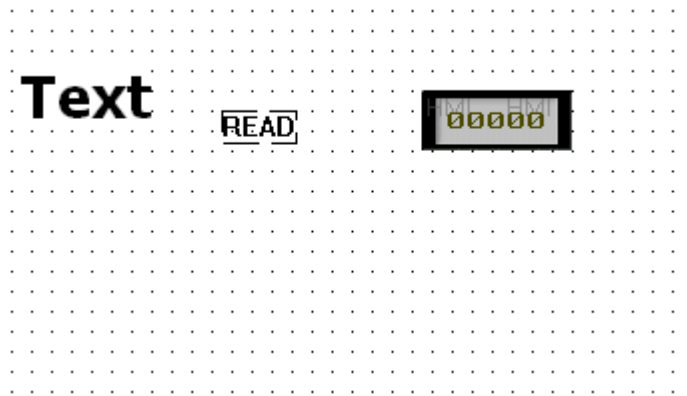





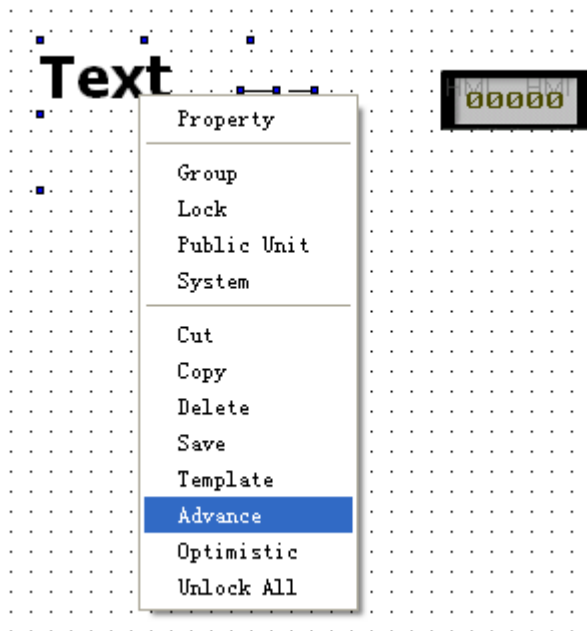

Step3: Advanced Operations

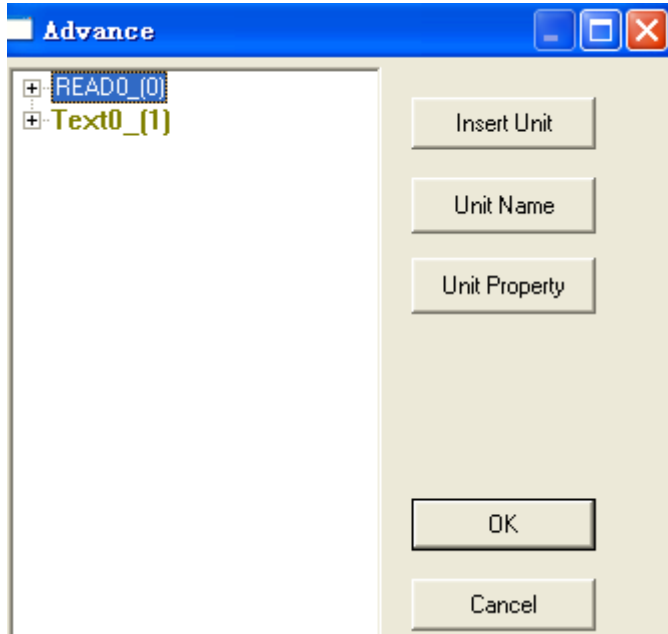
1. Select "Text" and "Read" at the same time, Right-click the selected area, Pop-up the following dialog box :



2. Choose Advanced, advanced dialog box as follows:



3. Click the plus sign  in front of  , then click the plus sign  in front of  , open its self property, as follows, select  :

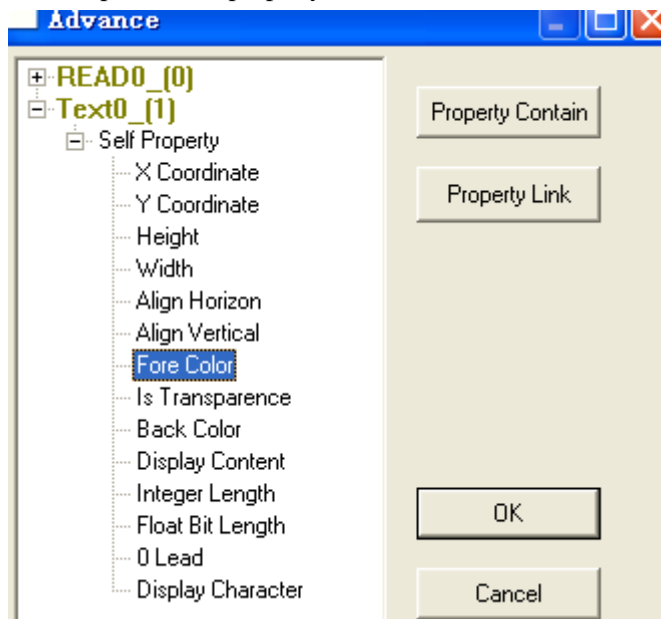

4. Click the right button  in the dialog box, the button will be grayed-out non-operational status, while text changed into “affirm contain”, as follows:

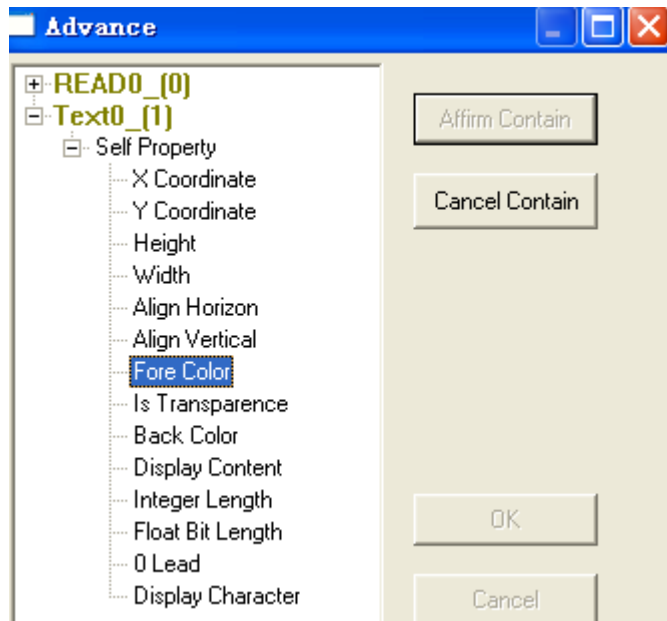

5. Select **+** READ0_(0) , button **Affirm Contain** immediately changed into operational status , as follows:

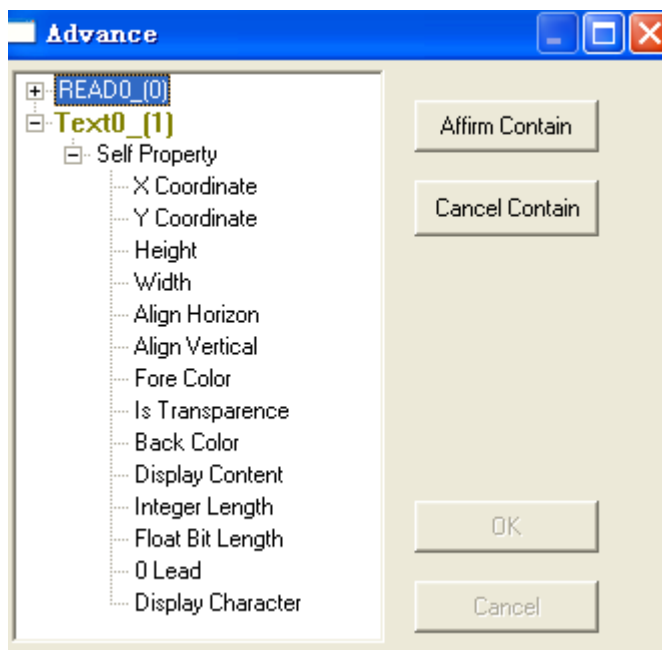

6. Click **Affirm Contain** button, complete Component contain.

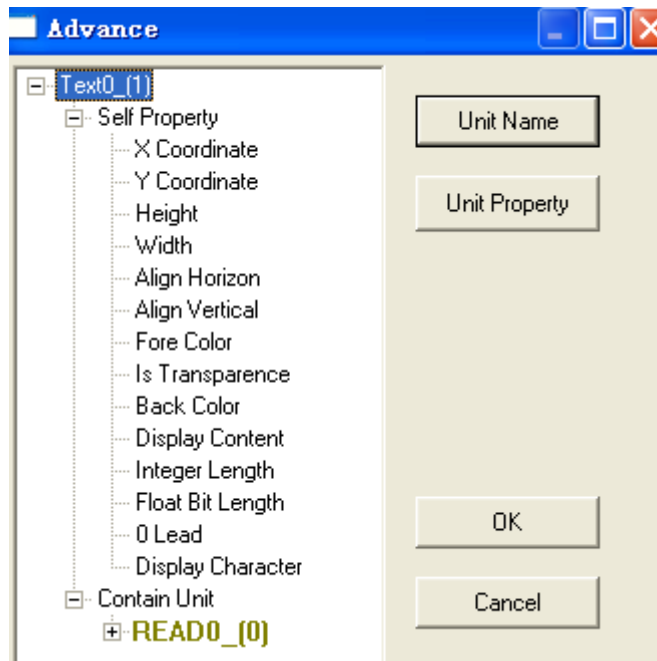

7. Click “OK” button to complete the advanced operations, the final picture is as follows:

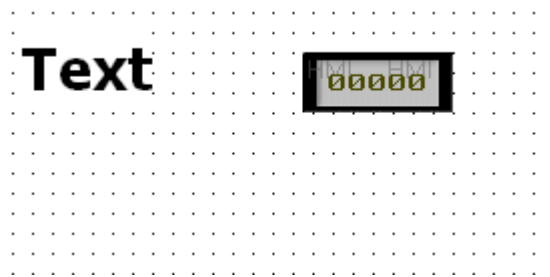

8. Trough “offline simulation” to observe the effects, as follows:



5.6 Register control switch pictures

- **Overview**

Users who are familiar with the basic functions of touch-screen may have some knowledge about “Dynamic Map”  component in the software, but the number of added pictures is limited, this can not satisfy customer's requirement. So we introduce the use of advanced function to achieve pictures switch.

- **Routine**

Step1: Building a new create, placing pictures on the screen:

Click the material library icon , open the Properties dialog box, as follows:

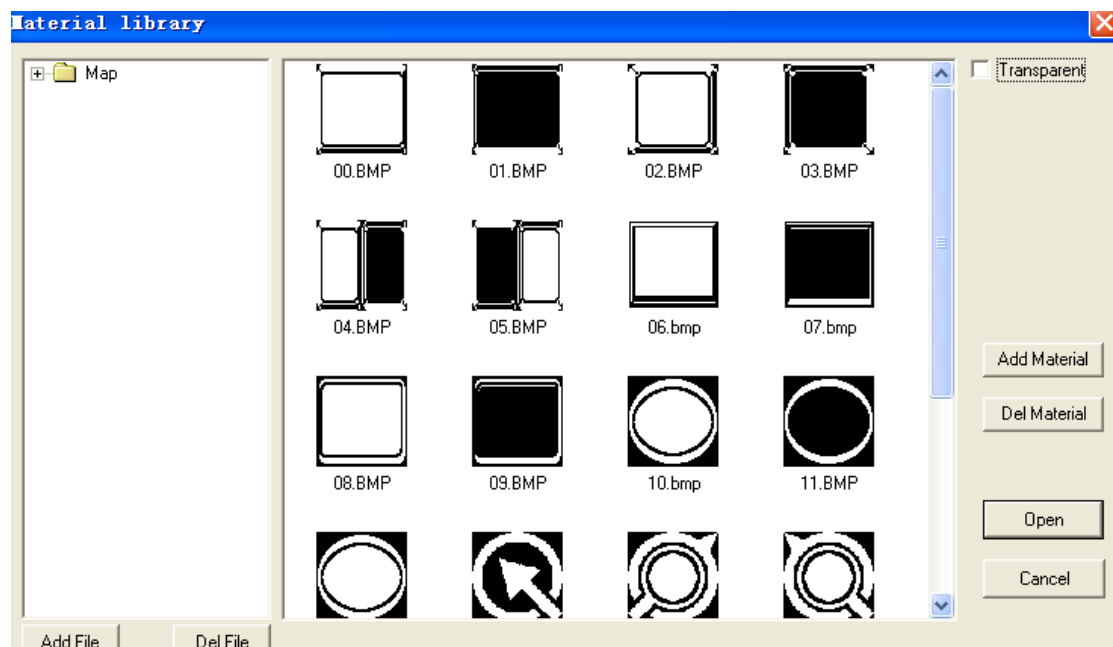

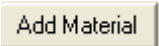
2. Click  button, pop-up the following dialog box:

3. In the drop-down list of my document, find the pictures what you want:

4. Click “open” button, you can add pictures to a blank area of the right material library, as shown below:

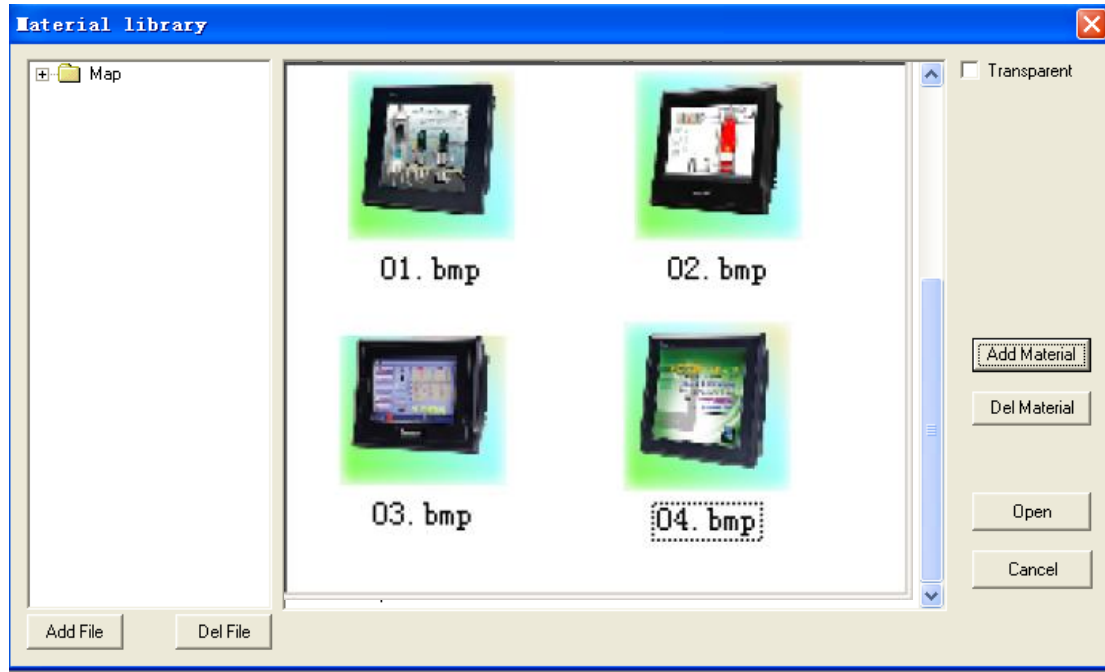

5. Select the picture you want to add, click “open” button, You can add pictures to the screen, as shown below:

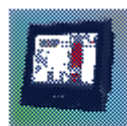
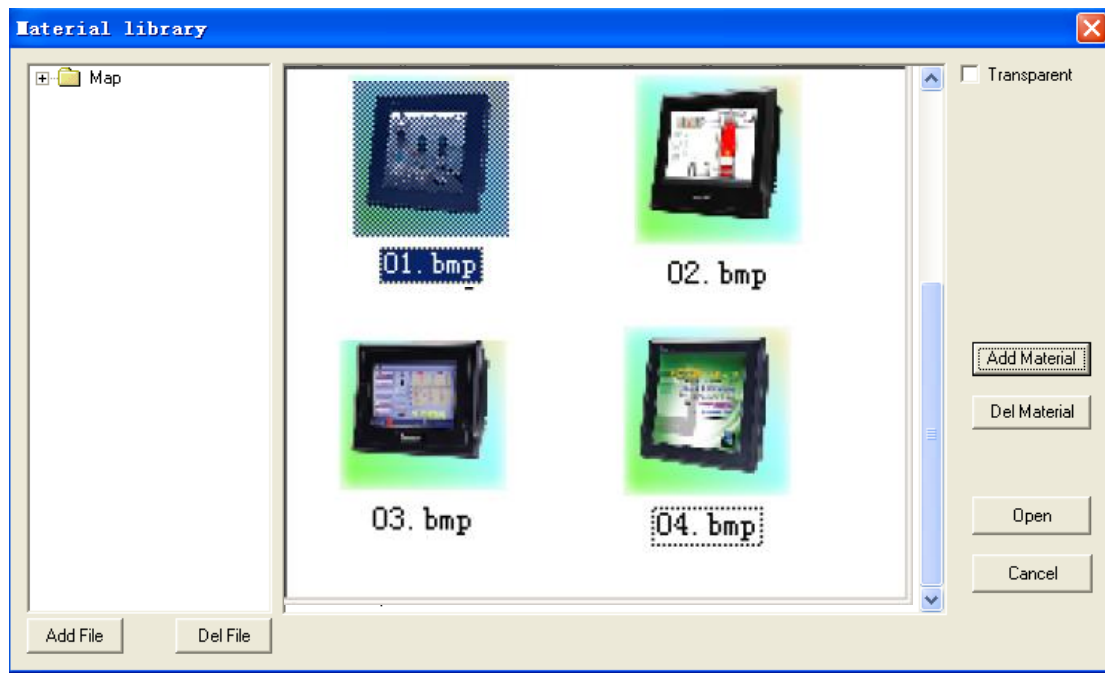

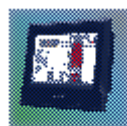
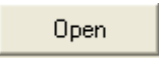

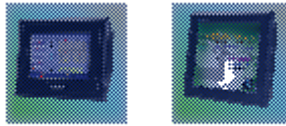



6. Click  again, select  in the dialog box, click  button, the



picture can be added to the screen, In turn add  and  to the screen, the final screen as shown below:



(Note: Due to the use of material library icon  , all pictures added to the screen in the default location (0,0), so you can see the above phenomenon ,actually it overlay by four pictures. Similarly, users can use touch-screen software of tool bar pictures  to add pictures ,also users who use  can freely control the size of pictures, while using  to add pictures, Picture size is the default size of the image itself, To the specific operations of  , please refer to the third TP Edition touch screen manual.

Step2: Add the following components: one digital input , one “Switch” and one “read” advanced command .



Modify properties:

1. Double-click “digital input”, open the Properties dialog box, in **Object** option , modify object to PSW300, as follows:

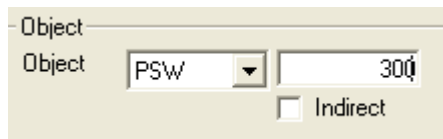

2. In the **Input** option, set **Max** as 3, set **Min** as 0, as follows:

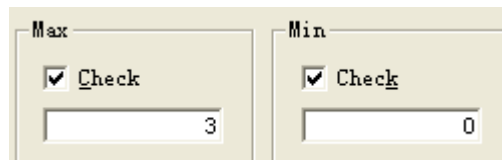

3. Double-click “Read”, open the Properties dialog box, in **Object** option , modify object to PSW300, as follows:

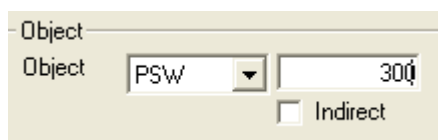



Step3: Advanced Operations

1. Select all the parts at the same time, Right-click the selected area, choose Advanced ,as follows:

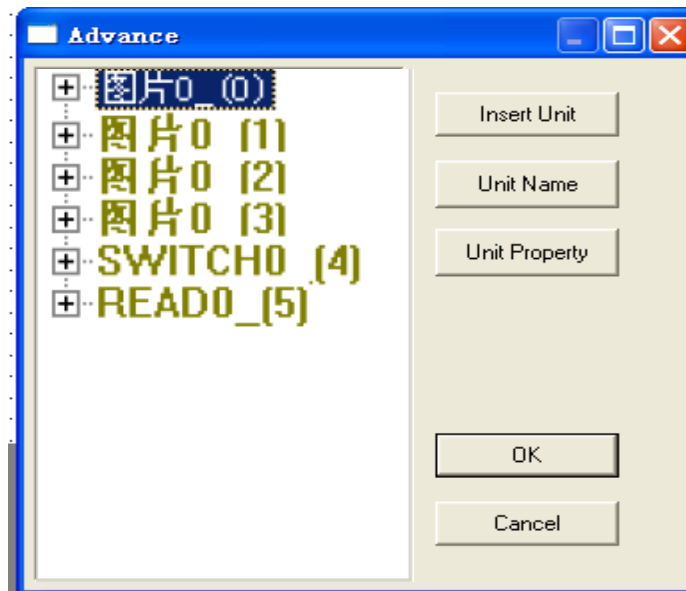

2. Pop-up the following advanced dialog box:



3. Select 图片0 (0), Click the right button  in the dialog box, the button will be grayed-out non-operational status, while text changed into “affirm insert”, as follows:

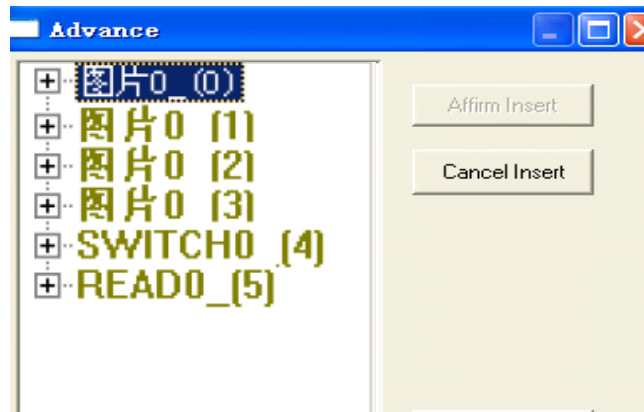

4. Select **SWITCH0 (4)** , button immediately changed into operational status, as follows:

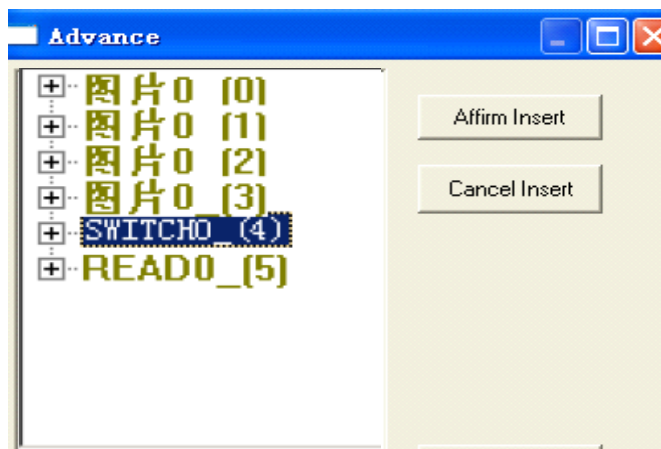

5. Click  button, complete **SWITCH0 (4)** Component insertion.



6. With the same operations ,to 图片0 (1) 、 图片0 (2)、 图片0 (3), In turn inserted into SWITCH0 (4) . The final screen effect is shown below:

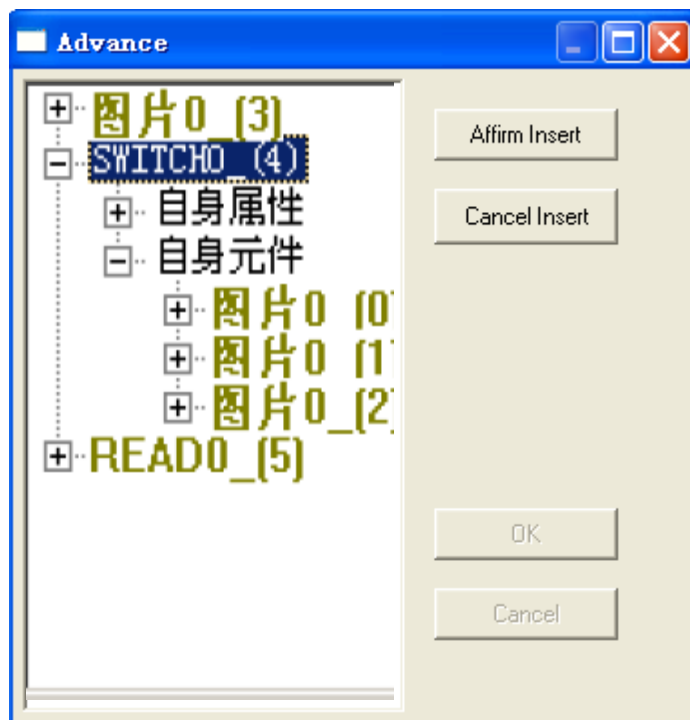

7. Click  before SWITCH0 (4) , open Self Property, select Current Index, as follows:



8. Click the right button **Property Contain** in the dialog box, the button will be grayed-out non-operational status, while text changed into “affirm contain”, as follows:



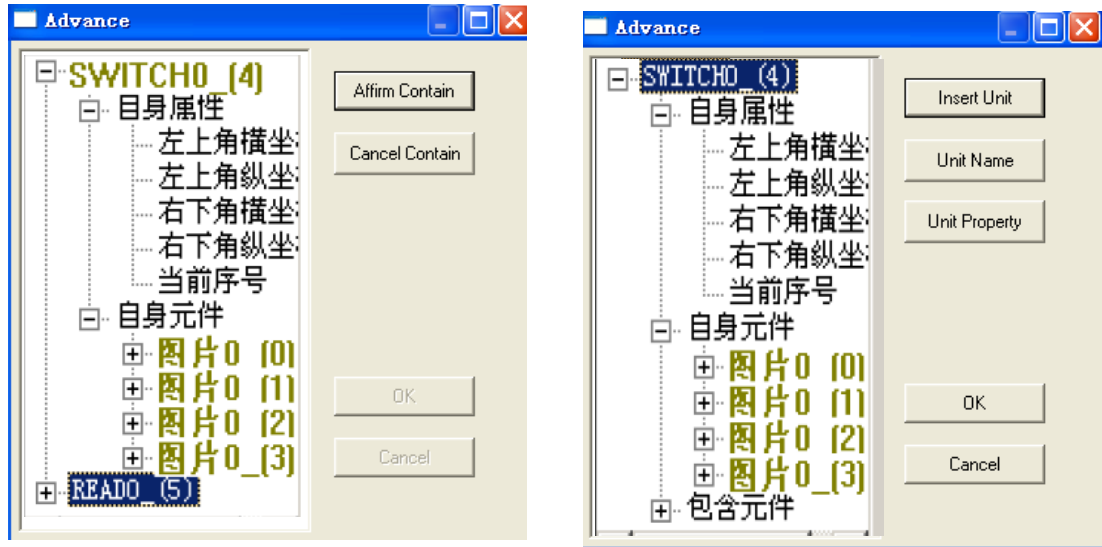

9. Select **READ0_ (5)**, button **Affirm Contain** immediately changed into operational status ,
Click **Affirm Contain** button, complete property contain, as follows:

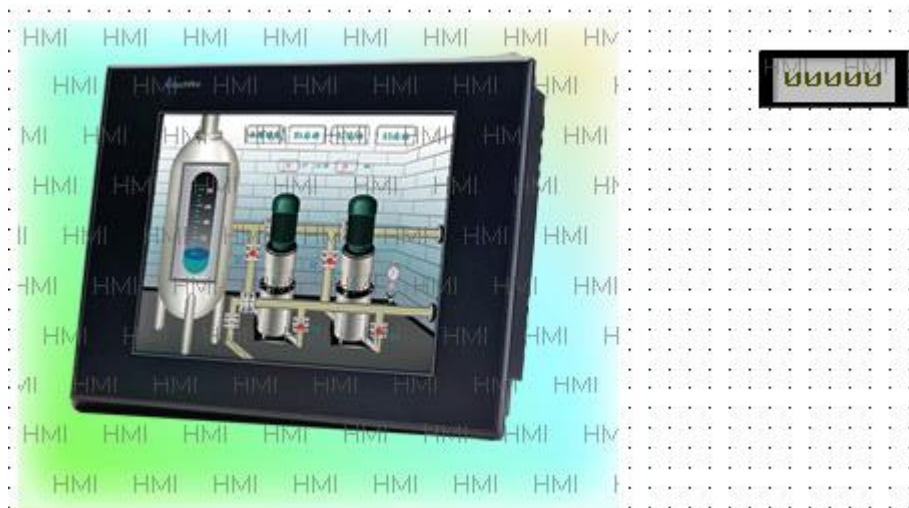

10. Finally click the “Ok” button to complete the advanced operation.

The final screen result is as follows:



11. Click the “off-line simulation” icon  on the software, According to the different input data values, display different images, See the following simulation results:

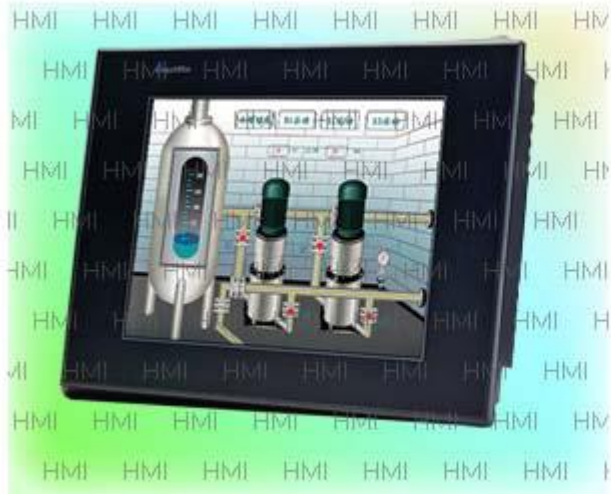



5.7 Word control coil output

- **Overview**

It is similar to revolving lantern. Revolving lantern is auto controlled by process, Words control coil output can be manually controlled, or auto controlled, In practical application, many projects like fractionize every word to every bit. this section we will introduce Words control coil output

- **Routine**

Step1: Building a screen, placing parts

Building a new screen, placing the following components on the screen: four lamp , one

digital input , four function field , one , one , four .

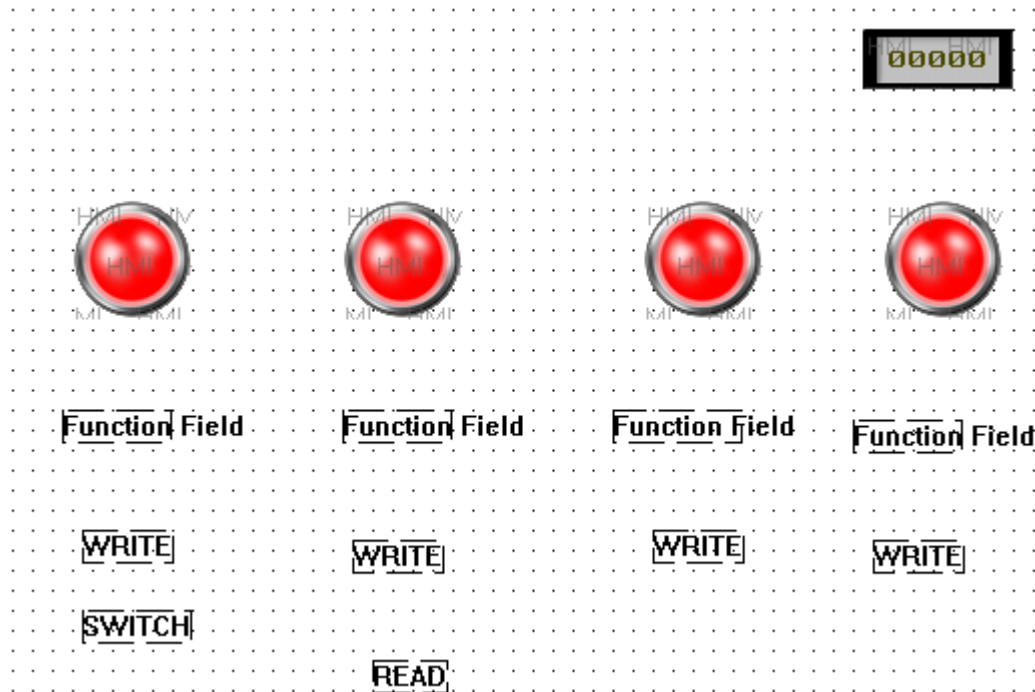

Step2: Modify properties

1. Double-click the first “lamp”, open the Properties dialog box, in **Object** option , modify object to PSB300, as follows:



2. Double-click the second “lamp”, open the Properties dialog box, in **Object** option , modify object to PSB301, as follows:

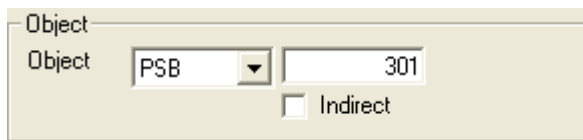

3. Double-click the third “lamp”, open the Properties dialog box, in **Object** option , modify object to PSB302, as follows:

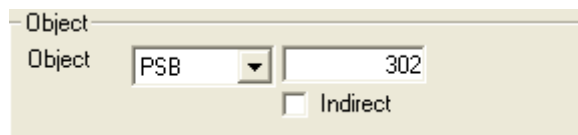

4. Double-click the second “lamp”, open the Properties dialog box, in **Object** option , modify object to PSB303, as follows:

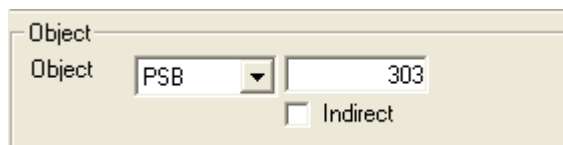

5. Double-click “digital input”, open the Properties dialog box, in **Object** option ,

modify object to PSW300, as follows:

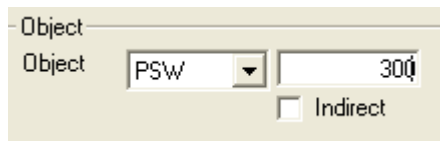

6. In the **Input** option, set **Max** as 3, set **Min** as 0, as follows:



7. Double-click the first “function field”, open the Properties dialog box, in **Mode** option, select **Coil Spring**, then click **...** button, in the pop-up dialog box, modify object to PSB300, as follows:

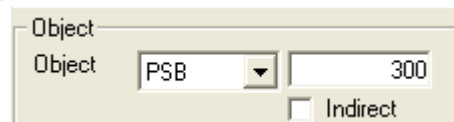

8. Open **Function** option, in the **AL**, select **Reset Coil**, continuous hit **Add** button three times, in the left **Function** area, you can see the right picture:

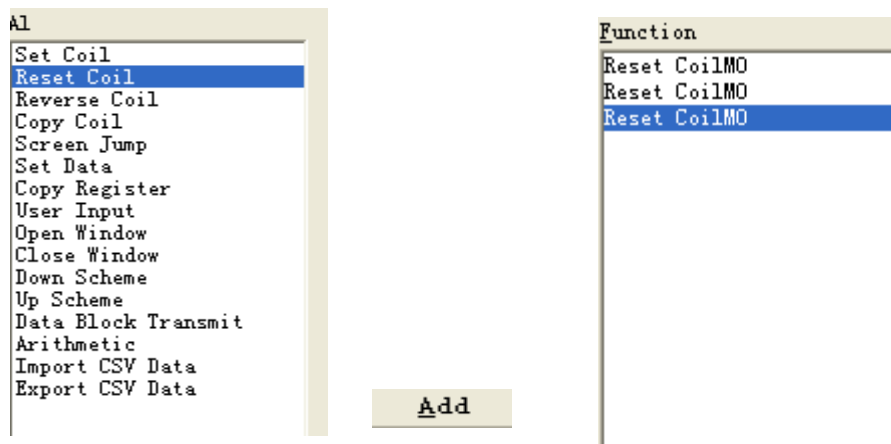

9. Double-click the first “Reset Coil”, open the Properties dialog box, in **Object** option, modify object to PSB301, as follows:

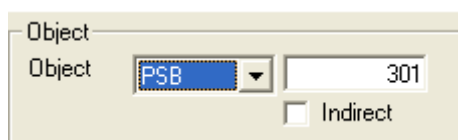

10. The same operational, to the second and third “Reset Coil”, point separately to PSB302 and PSB303, as follows:

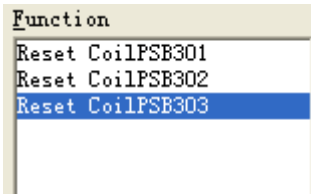

11. Double-click the second “function field”, open the Properties dialog box, in **Mode** option , select **Coil Spring** ,then click **...** button, in the pop-up dialog box, modify object to PSB301, as follows:

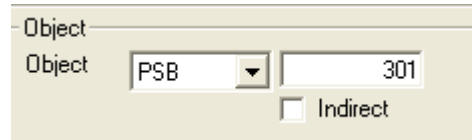

12. Open **Function** option, in the **Al** ,select **Reset Coil** , continuous hit **Add** button three times, modify the property of the three “Reset Coil” , point separately to PSB300, PSB302 and PSB303, as follows:

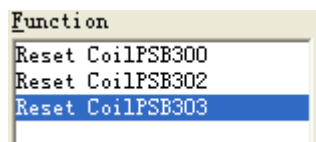

13. Double-click the third “function field”, open the Properties dialog box, in **Mode** option , select **Coil Spring** ,then click **...** button, in the pop-up dialog box, modify object to PSB302, as follows:

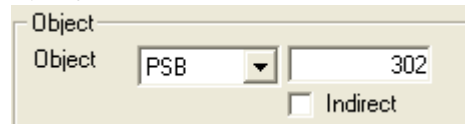

14. Open **Function** option, in the **Al** ,select **Reset Coil** , continuous hit **Add** button three times, modify the property of the three “Reset Coil” , point separately to PSB300, PSB301 and PSB303, as follows:

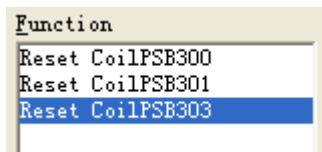

15. Double-click the fourth “function field”, open the Properties dialog box, in **Mode** option , select **Coil Spring** ,then click **...** button, in the pop-up dialog box, modify object to PSB303, as follows:

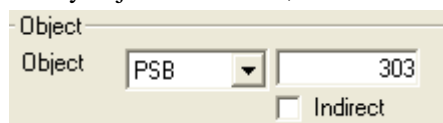

16. Open **Function** option, in the **AL**, select **Reset Coil**, continuous hit **Add** button three times, modify the property of the three “Reset Coil”, point separately to PSB300, PSB301 and PSB302, as follows:

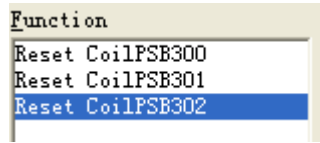

17. Double-click the first “write”, open the Properties dialog box, here the **Type** is Bit, set **Object** as PSB300, **Set Data** is 1, as follows:

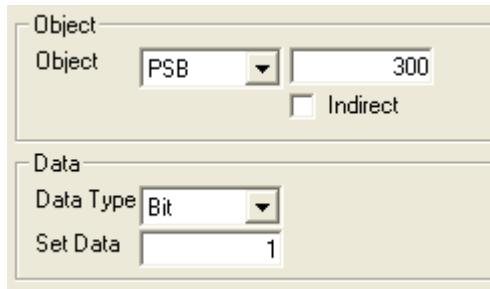

18. Double-click the second “write”, open the Properties dialog box, here the **Type** is Bit, set **Object** as PSB301, **Set Data** is 1, as follows:

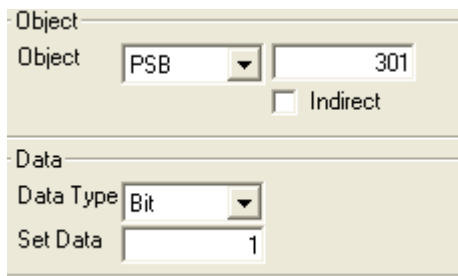

19. Double-click the third “write”, open the Properties dialog box, here the **Type** is Bit, set **Object** as PSB302, **Set Data** is 1, as follows:

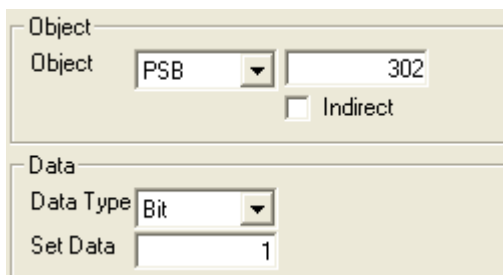

20. Double-click the third “write”, open the Properties dialog box, here the **Type** is Bit, set

Object as PSB303, Set Data is 1, as follows:

21. Double-click “READ”, open the Properties dialog box , set Unit Type as Register , set Object to PSW300,as follows:

Step3: Advanced Operations

1.Select Switch、 Read and four Write at the same time, Right-click the selected area, choose Advanced ,as follows:

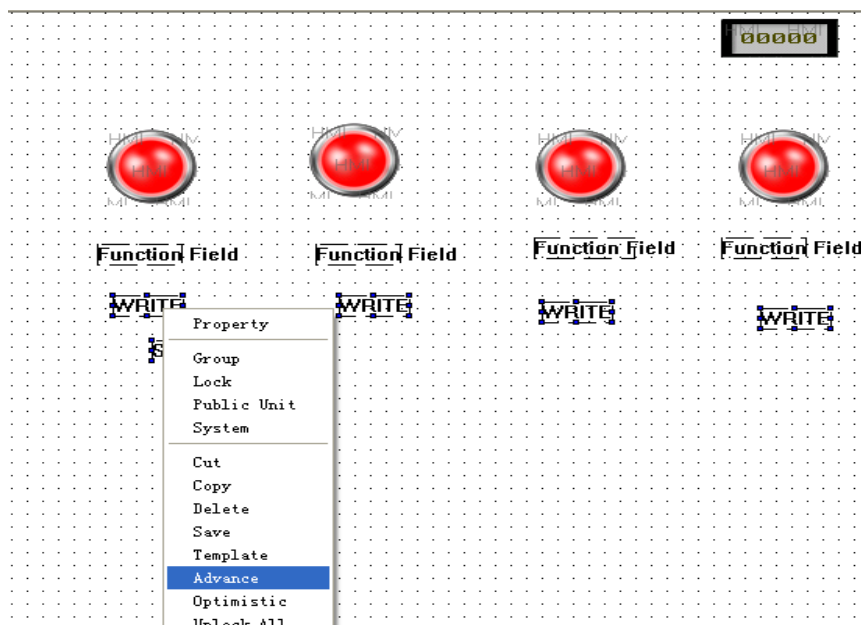

2. Pop-up the following advanced dialog box:

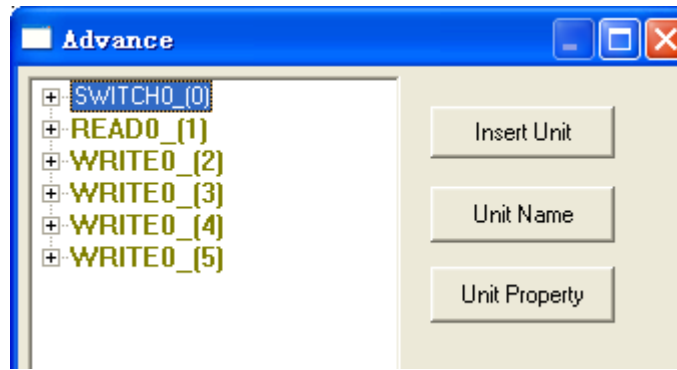

3. Click before **SWITCH0_0**, open **Self Property**, select **Current Index**, as follows:

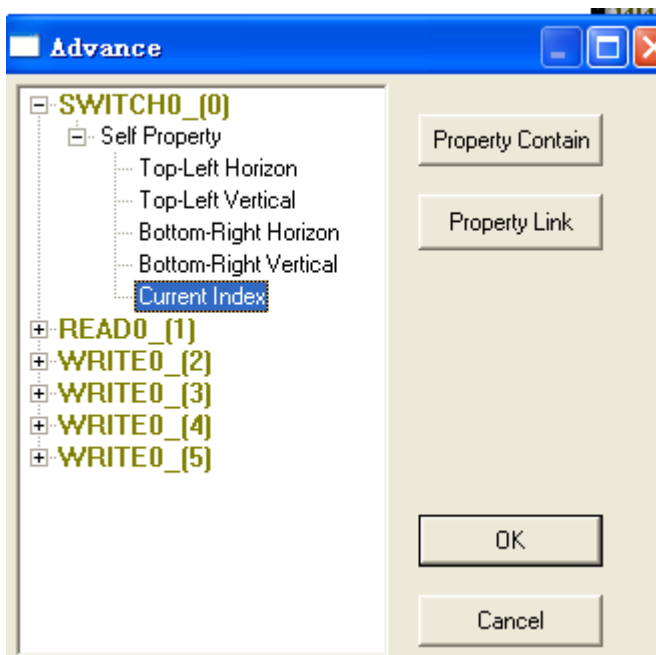

4. Click the right button **Property Contain** in the dialog box, the button will be grayed-out non-operational status, while text changed into “affirm contain”, as follows:

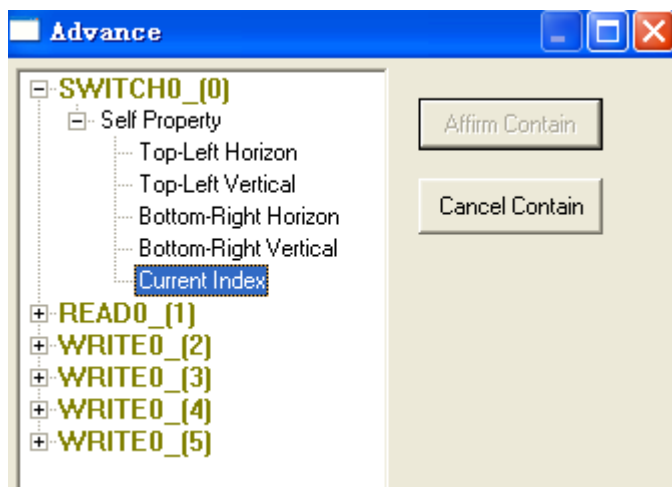

5. Select **READ0_1**, button **Affirm Contain** immediately changed into operational status, as

follows:

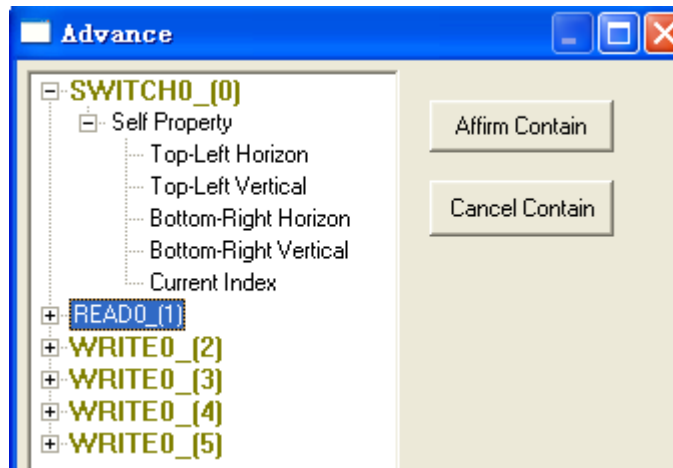

6. Click **Affirm Contain** button, complete **SWITCH0_0** directive's Component contain. select

WRITE0_2, Click the right button **Insert Unit** in the dialog box, the button will be grayed-out non-operational status, while text changed into "affirm insert", as follows:

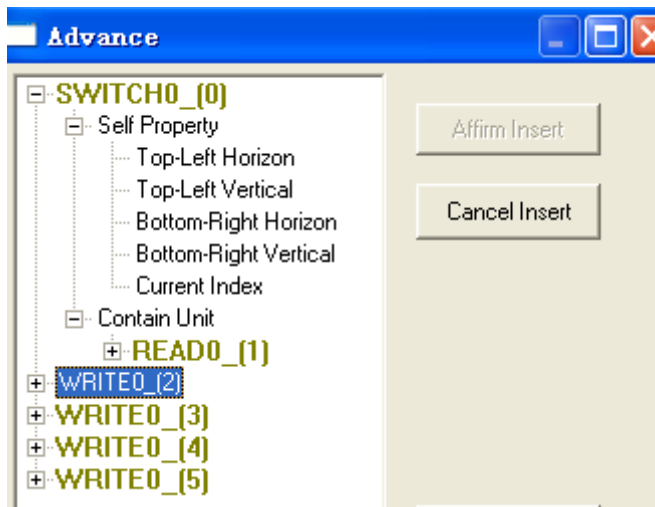

7. Select **SWITCH0_0**, button immediately changed into operational status, as follows:

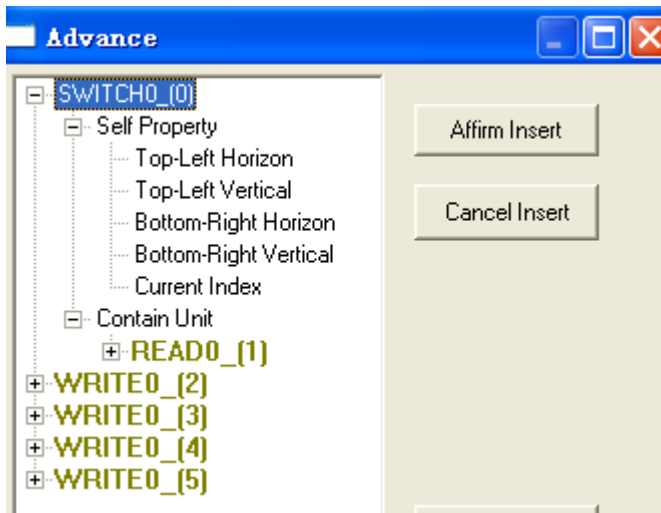

8. Click button, complete SWITCHO_0 Component insertion, as follows:

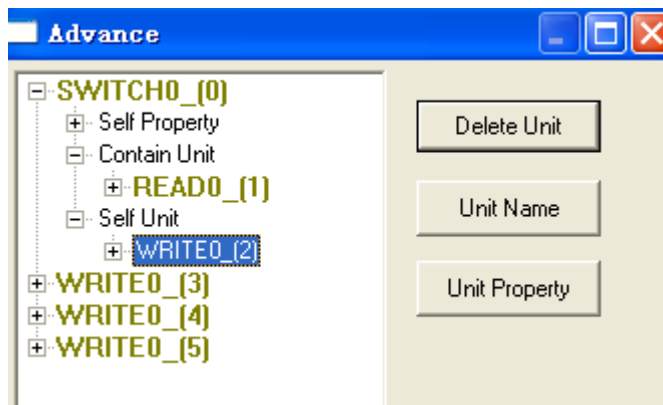

9. With the same operations completing the other three write components' insertion, the effect is shown below:

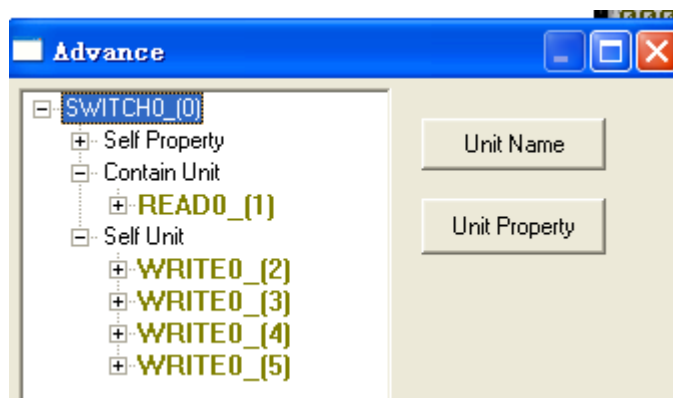

Finally click the “Ok” button to complete the advanced operation.
The final screen results are as follows:

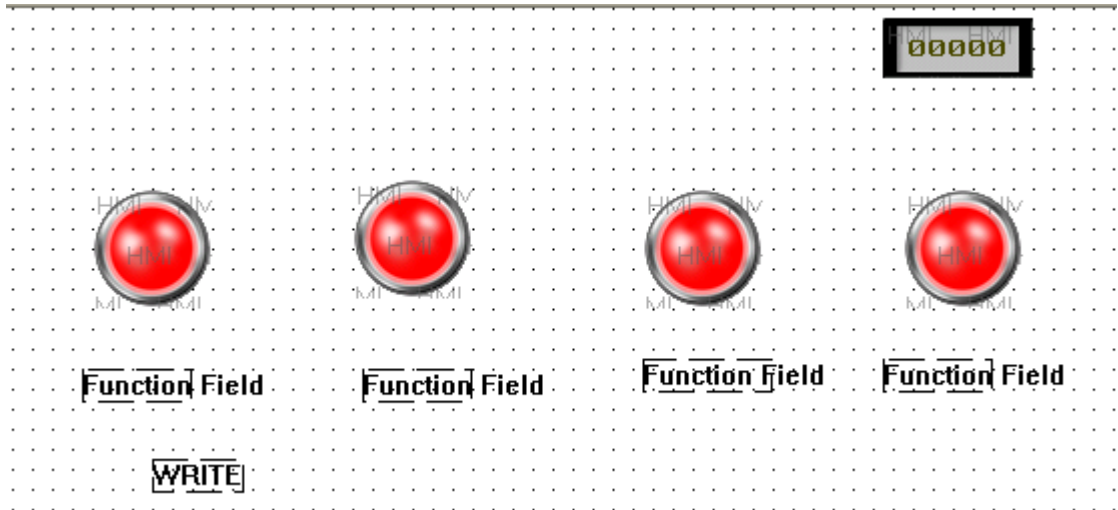

10. Click the “off-line simulation” icon  on the software, See the following simulation results:

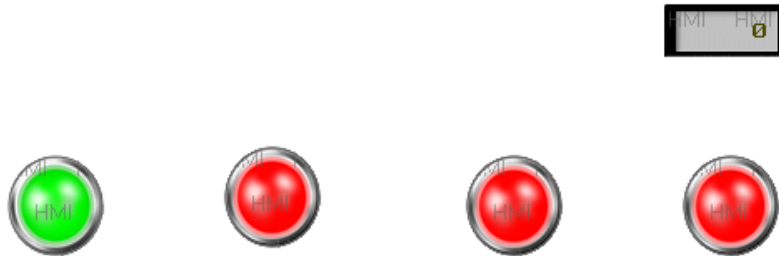

Note: In the data box, enter 0, the left side of the first indicator light;
 In the data box, enter 1, the left side of the second indicator light;
 In the data box, enter 2, the left side of the third indicator light;
 In the data box, enter 3, the left side of the fourth indicator light;

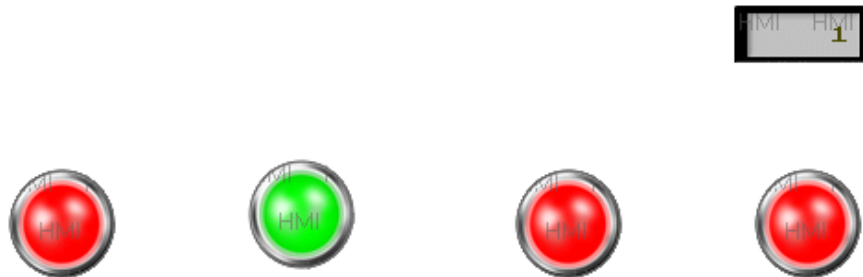



5.8 Scroll Text

- **Overview**

Screen production process in the engineering, as the start screen, often related to the company name, brand, or other information Scrolling move in the screen. In the following we will illustrate how to make scroll text which can set travelling speed.

- **Routine**

Step1: Building a new screen, placing the following components on the screen: one digital display , one digital input , here modify their property, point separately to PSW300 and PSW301, as follows:

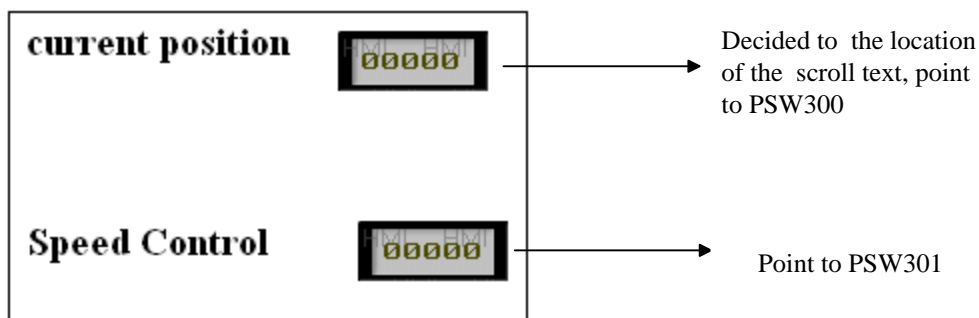

Step2: Add one text  on the screen, In the “position” option, select “Vertical”, point to PSW300. as follows:

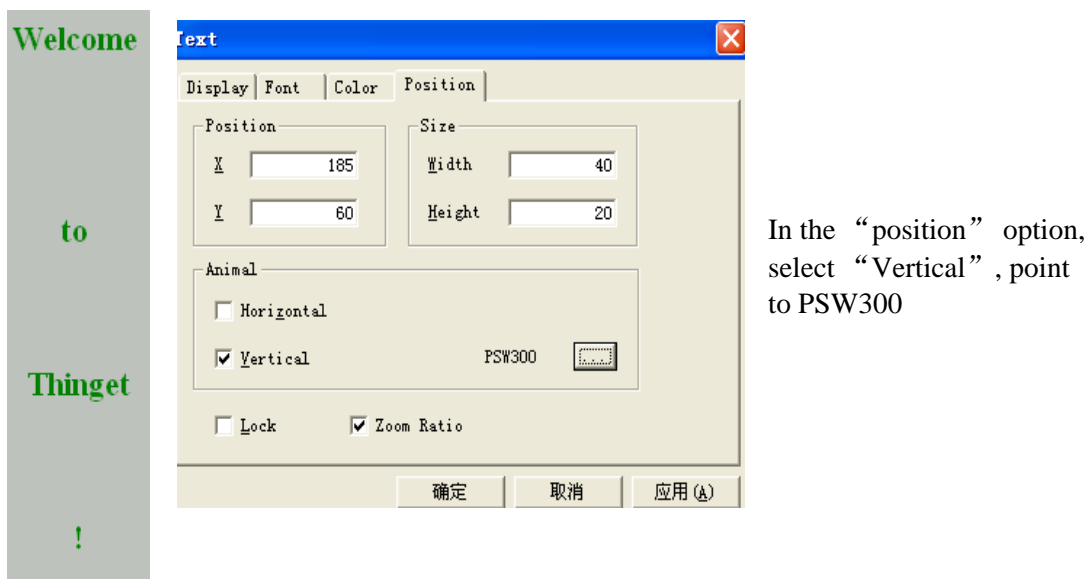

Step3: Achieve the value of PSW300 increased each 100ms, put a “function filed”

 component in the screen.

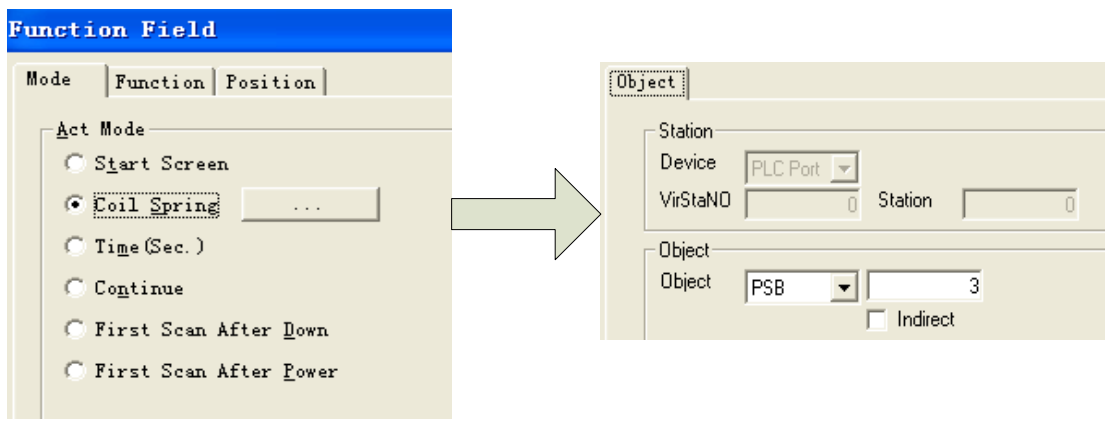

Note: PSB3 is a pulse coil within 100ms periodic.

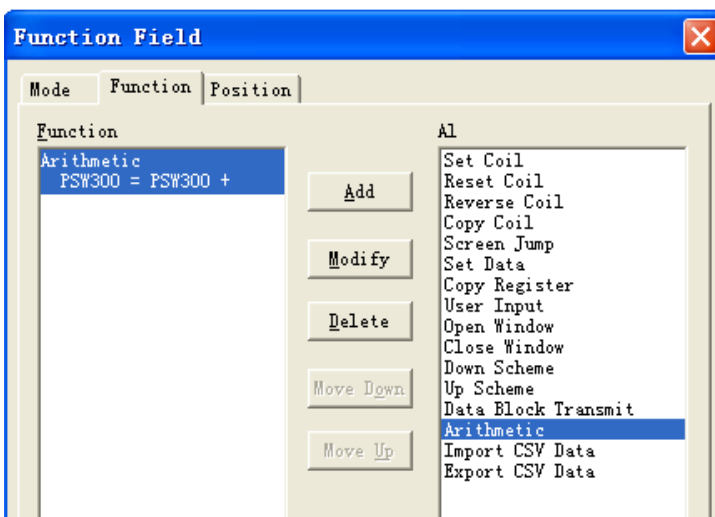

Click **Function** option, Add arithmetic to the left function area, as follows:



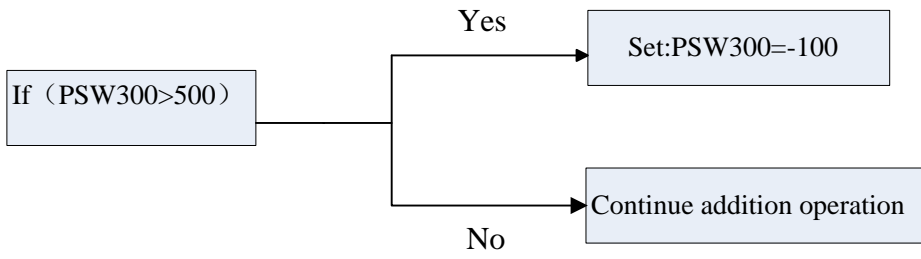

As the following setting:
 Select operate kind as 
 Object is PSW300
 Left operand is PSW300
 Right operand is PSW301

Step4: Value comparison operations



placing the following components on the screen: one If advanced command , one , one

read advanced command  and one write advanced command , as follows;

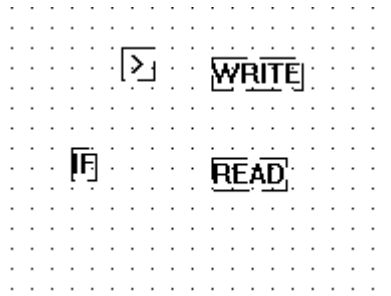

Modify their properties:

- a. To read component, point object to PSW300.

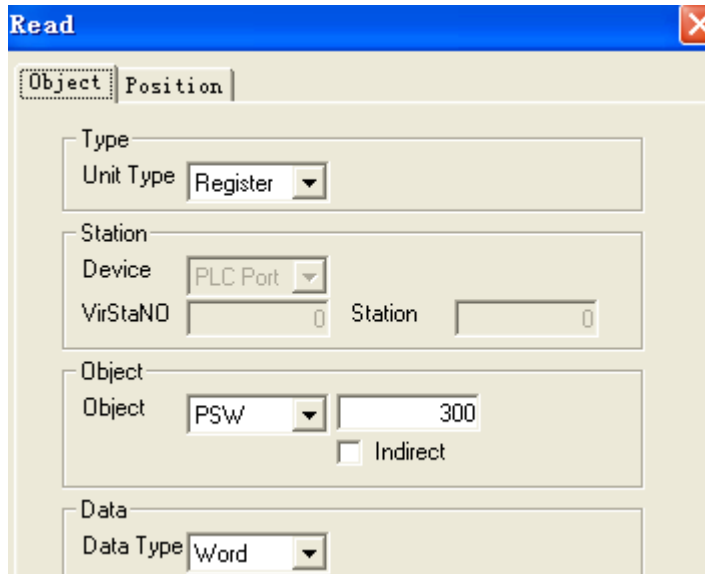

- b. To compare component, point left operate to read, set right operate as 500.

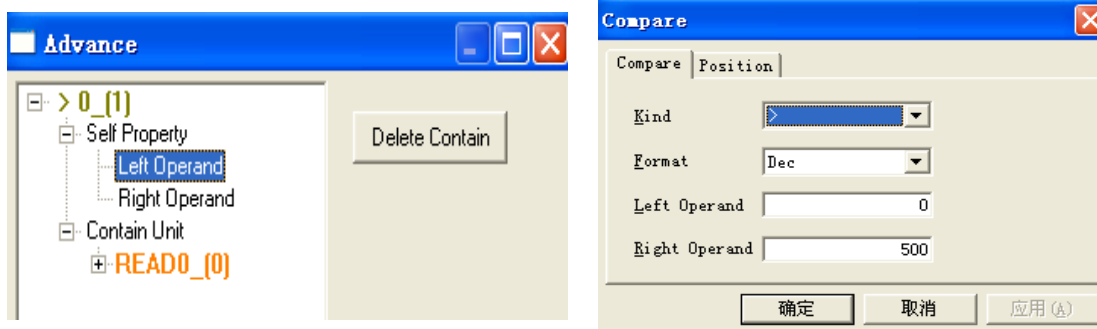

- c. Implementation of Conditional judgment

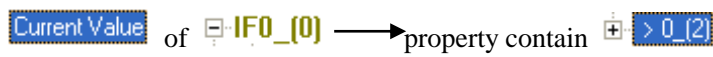

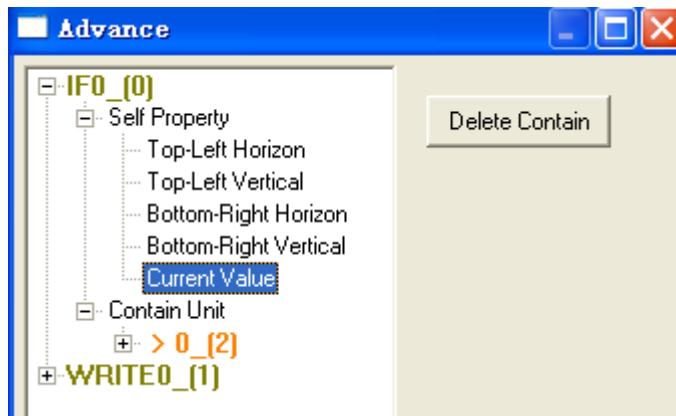

Choose **WRITE0_1** → Click **Insert Unit**, finally complete the insertion.

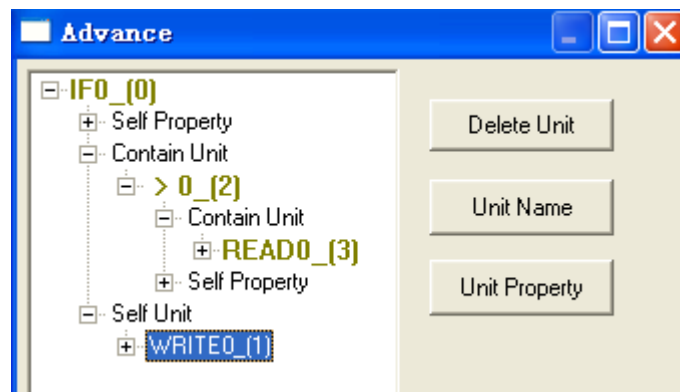

Modify Write component's object to PSW300. set date as -100.

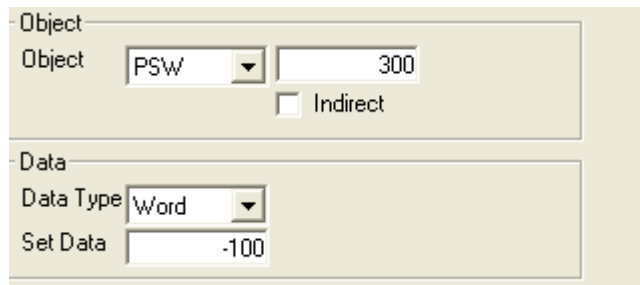

d. Finally the screen is shown below:

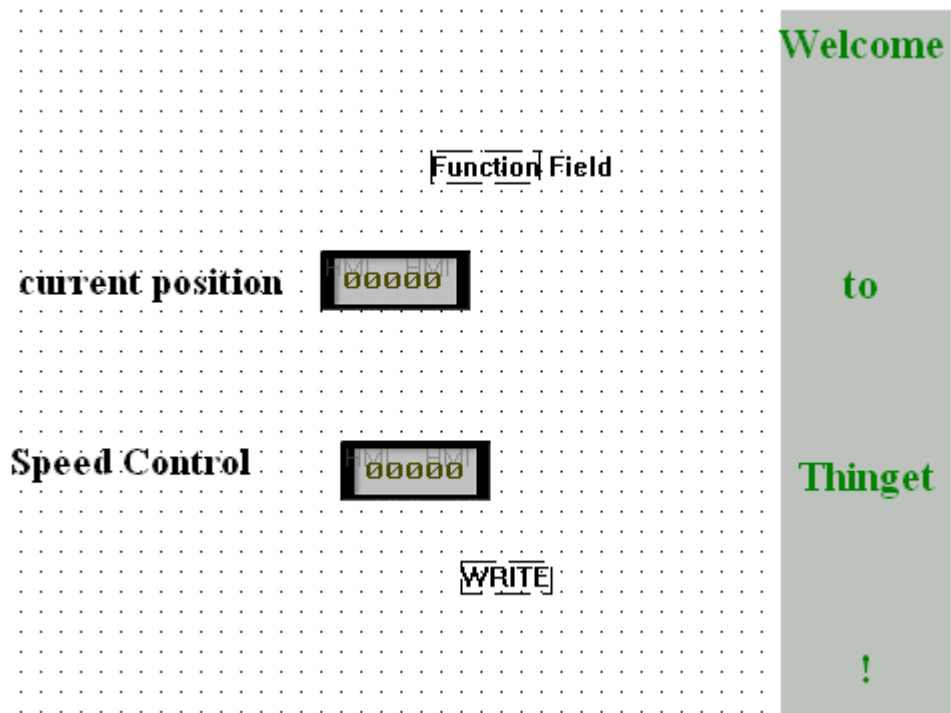

Step5: Click the “off-line simulation” icon on the software , Input value in the speed control box, See the following simulation results:

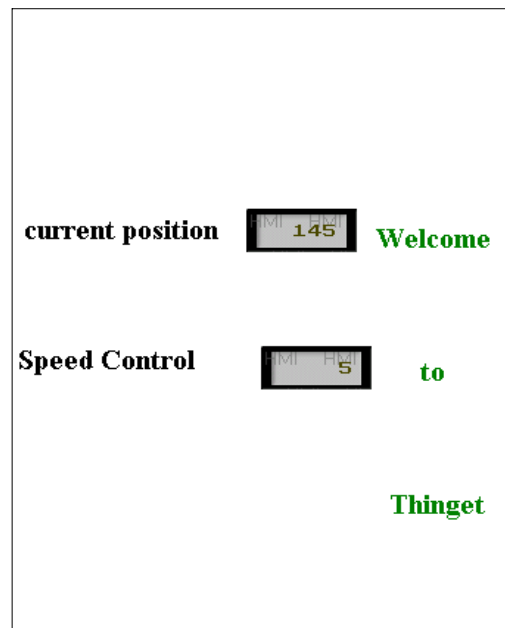
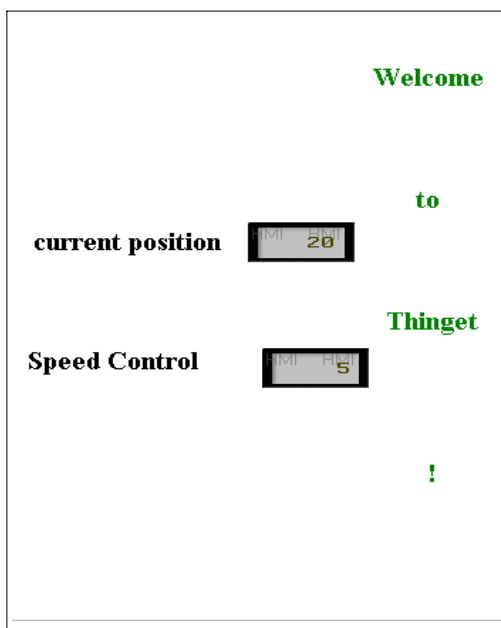



WUXI XINJE ELECTRIC CO., LTD.

4th Floor, Building 7th, No.100 Dicui Rd,
Wuxi, China

Tel: 86-0510-85134139

Fax: 86-0510-85111290

www.xinje.com

Email: cheerfiona@gmail.com