



# **L series remote IO**

**User manual**

Wuxi Xinje Electric Co., Ltd.

Data No. PL04 20211110EN 3.5

This manual contains basic precautions to ensure personal safety and protect this product and connected equipment. These precautions are highlighted in the manual with warning triangles. For other unfinished matters, please follow the basic electrical operation procedures.

Installation  
notes



---

Please observe the precautions. If you do not adopt the correct operating procedures, the control system may work incorrectly or abnormally, and serious property damage may be caused.

---

Correct  
application



---

The equipment and its parts can only be used for the applications described in the product catalogue and technical description, and can only be used with the equipment or parts produced by peripheral manufacturers approved or recommended by Xinje.

The product can operate normally only if it is transported, stored, configured and installed correctly, and operated and maintained according to the recommendations.

---

WUXI XINJE ELECTRIC CO., LTD. All rights reserved

This material or its contents shall not be copied, transmitted or used without explicit written permission.

Violators shall be liable for the losses caused. All rights provided in the patent license and registration including utility modules or designs are reserved.

Statement of responsibility

We have checked that the contents of this manual are consistent with the hardware and software described, because errors are inevitable, we cannot guarantee complete consistency. However, we will often check the data in the manual and make necessary corrections in future editing. Welcome your valuable comments.

March, 2021

---

# Catalog

<b>1. SYSTEM OVERVIEW .....</b>	<b>1</b>
1-1. SYSTEM INDICATOR .....	1
1-2. SYSTEM STRUCTURE .....	2
1-3. EMC .....	3
1-4. ENVIRONMENTAL CONDITIONS FOR TRANSPORTATION, STORAGE AND OPERATION .....	3
<b>2. LC3-AP ADAPTER MODULE.....</b>	<b>1</b>
2-1. DIMENSION .....	1
2-2. TECHNICAL SPECIFICATION.....	1
2-3. ELECTRICAL WIRING DIAGRAM.....	2
2-4. INSTALLATION STEPS .....	2
<b>3. I/O MODULE XL-ENXMY .....</b>	<b>4</b>
3-1. FEATURES AND SPECIFICATIONS.....	4
3-1-1. <i>Model list</i> .....	5
3-1-2. <i>Module specification</i> .....	5
3-2. TERMINALS.....	5
3-2-1. <i>Connector specifications</i> .....	6
3-3. I/O ADDRESS .....	6
3-4. EXTERNAL WIRING.....	7
3-4-1. <i>Input terminal wiring</i> .....	7
3-4-2. <i>Output terminal wiring</i> .....	8
3-4-3. <i>External terminal block</i> .....	8
3-5. MODULE PARAMETERS .....	9
3-5-1. <i>#x5000 bit definition</i> .....	10
3-6. DIMENSION .....	12
<b>4. ANALOG I/O MODULE XL-E4AD2DA.....</b>	<b>14</b>
4-1. FEATURES AND SPECIFICATION .....	14
4-1-1. <i>Features</i> .....	14
4-1-2. <i>Specification</i> .....	14
4-2. TERMINALS.....	15
4-2-1. <i>Terminal arrangement</i> .....	15
4-2-2. <i>Terminal signals</i> .....	15
4-2-3. <i>Wire connector specification</i> .....	15
4-3. I/O ADDRESS .....	16
4-4. WORKING MODE .....	17
4-4-1. <i>Configuration panel</i> .....	17
4-4-2. <i>Bit definition of #x5000</i> .....	17
4-5. EXTERNAL WIRING.....	18
4-5-1. <i>Voltage single end input</i> .....	18
4-5-2. <i>Voltage single end output</i> .....	19
4-5-3. <i>Current single end input</i> .....	19
4-5-4. <i>Current single end output</i> .....	19
4-6. AD CONVERSION DIAGRAM .....	20

4-7. DIMENSION .....	21
<b>5. ANALOG INPUT MODULE XL-E8AD-A .....</b>	<b>23</b>
5-1. FEATURES AND SPECIFICATIONS.....	23
5-1-1. Features.....	23
5-1-2. Specifications .....	23
5-2. TERMINALS.....	24
5-2-1. Terminal arrangement.....	24
5-2-2. Terminal signals .....	24
5-2-3. Wire connector specification.....	24
5-3. I/O ADDRESS .....	25
5-4. WORKING MODE .....	26
5-4-1. Configuration panel.....	26
5-4-2. #x5000 bit definition .....	26
5-5. EXTERNAL WIRING.....	27
5-5-1. Current single end input .....	27
5-6. ANALOG DIGITAL CONVERSION DIAGRAM .....	28
5-7. DIMENSION .....	28
<b>6. ANALOG INPUT MODULE XL-E8AD-V .....</b>	<b>29</b>
6-1. FEATURES AND SPECIFICATION .....	29
6-1-1. Features.....	29
6-1-2. Specification.....	29
6-2. TERMINALS.....	30
6-2-1. Terminal arrangement.....	30
6-2-2. Terminal signals .....	30
6-2-3. Wiring connector specification .....	30
6-3. I/O ADDRESS .....	31
6-4. WORKING MODE .....	32
6-4-1. Panel configuration.....	32
6-4-2. #x5000 bit definition .....	32
6-5. EXTERNAL WIRING.....	33
6-5-1. Voltage single end input.....	33
6-6. ANALOG DIGITAL CONVERSION DIAGRAM .....	33
6-7. DIMENSION .....	34
<b>7. ANALOG OUTPUT MODULE XL-E4DA .....</b>	<b>35</b>
7-1. FEATURES AND SPECIFICATION .....	35
7-1-1. Features.....	35
7-1-2. Specification.....	35
7-2. TERMINALS.....	36
7-2-1. Terminal arrangement.....	36
7-2-2. Terminal signals .....	36
7-2-3. Wiring connector specification .....	36
7-3. I/O ADDRESS .....	37
7-4. WORKING MODE .....	38
7-4-1. Panel configuration.....	38
7-4-2. #x5000 bit definition .....	38
7-5. EXTERNAL WIRING.....	39
7-5-1. Voltage single end output.....	39

---

7-5-2. <i>Current single end output</i> .....	39
7-6. ANALOG DIGITAL CONVERSION DIAGRAM .....	40
7-7. DIMENSION .....	40
<b>8. APPLICATION OF LC3-AP AND XINJE XG2 PLC .....</b>	<b>41</b>
8-1. SYSTEM CONFIGURATION.....	41
8-2. SYSTEM TOPOLOGY .....	41
8-3. DEBUGGING STEPS.....	41
8-3-1. <i>Add XML File</i> .....	41
8-3-2. <i>Create communication between XDPPro and XG2</i> .....	41
8-3-3. <i>Scan the slave station device</i> .....	42
8-3-4. <i>EtherCAT parameter configuration</i> .....	43
8-3-5. <i>Program</i> .....	44
<b>9. LC3-AP AND TWINCAT APPLICATION.....</b>	<b>45</b>
9-1. SYSTEM CONFIGURATION.....	45
9-2. SYSTEM TOPOLOGY .....	45
9-3. DEBUGGING STEPS.....	45
9-3-1. <i>Add XLM file</i> .....	45
9-3-2. <i>New project</i> .....	45
9-3-3. <i>Hardware scan</i> .....	46
9-3-4. <i>Slave station parameters</i> .....	47
9-3-5. <i>Create variables and link</i> .....	47
<b>10. LC3-AP AND CODESYS APPLICATION.....</b>	<b>52</b>
10-1. SYSTEM CONFIGURATION.....	52
10-2. SYSTEM TOPOLOGY .....	52
10-3. DEBUGGING STEPS.....	52
10-3-1. <i>New project</i> .....	52
10-3-2. <i>Add XML file</i> .....	53
10-3-3. <i>Add master station device</i> .....	55
10-3-4. <i>Gateway Communication Settings</i> .....	56
10-3-5. <i>Scan the slave station device</i> .....	57
10-3-6. <i>Set master station parameters</i> .....	58
10-3-7. <i>Program</i> .....	59
10-3-8. <i>Create variable connection</i> .....	61
10-3-9. <i>Slave station parameter</i> .....	64

# 1. System overview

Remote I/O is composed of Xinje LC3-AP adapter and XL series modules. Among them, LC3-AP adapter supports EtherCAT bus type master stations, such as Xinje XDH, XLH, XG2 and XS3 series master stations, which supports up to 32 slave stations. By matching different types and quantities of I/O modules, it can meet the different actual needs of users. Single module has stable performance, beautiful appearance, small size and high cost performance. The screw free terminal is adopted, which is simple and reliable, reduces the workload of on-site installation and saves installation time.

At present, the remote I/O module has been widely used in various industrial automation occasions. The product has high stability, strong anti-interference ability and excellent performance, which has been highly appreciated by users.

## 1-1. System indicator



The system indicator is defined as follows:

Abbreviation	Meaning
PWR	The power indicator lights up when the power system is normal
RUN	The operation indicator light is on when the system is in normal operation
ERR	The system fault indicator light is on when the system fails

### Run indicator

RUN indicator	Status	Notes
OFF	INT	Initialization
Slow flashing	PRE-OP	Pre-operation
Single flashing	SAFE-OP	Safe operation
ON	OP	Operation status
Fast flashing	BOOTSTRAP or loading the EEPROM	Downloading EEPROM

## Error indicator

ERR indicator	Notes	Solution
OFF	No Error	
Fast flashing	EEPROM loading error	<ol style="list-style-type: none"> <li>1. Power on again</li> <li>2. Update EEPROM</li> </ol>
Single flashing	AI status register error	<ol style="list-style-type: none"> <li>1. Check the configuration of master station and upper computer</li> <li>2. Reactivate the configuration</li> </ol>
Double flashing	Process data watchdog timeout	<ol style="list-style-type: none"> <li>1. Check whether the connection between slave station and master station is intact</li> <li>2. Check whether the master station reports an error</li> </ol>
ON	PDI watchdog timeout	<ol style="list-style-type: none"> <li>1. Check whether the connection between slave station and master station is intact</li> <li>2. Check whether the master station reports an error</li> <li>3. Check the site for excessive interference</li> <li>4. Power on again</li> </ol>

## 1-2. System structure

The wiring of Xinje remote IO system is very simple. Thanks to the star topology of EtherCAT, it can be replaced by a simple linear structure. EtherCAT does not need hubs and switches, it can easily realize the cascade of multiple slave stations, so the consumption of cables and bridges is greatly reduced, and the workload of connection design and joint calibration is also greatly reduced, saving time and cost in the process of installation and commissioning. It is recommended to use linear connection method for EtherCAT bus wiring. The wiring mode is shown in the figure below:

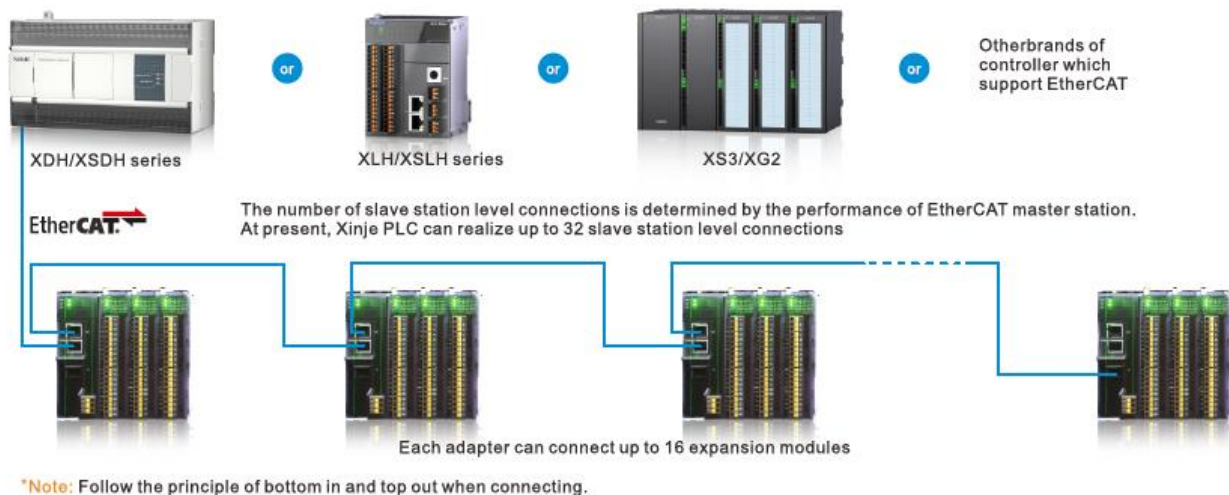

Note:

- (1) The two communication network ports of the adapter follow the principle of "bottom in and top out", that is, the EtherCAT master station must be connected with the bottom network port of the first adapter, and then the top network port of the first adapter is connected with the bottom network port of the second adapter, and so on.
- (2) The communication transmission process will inevitably be affected by the surrounding electromagnetic environment. It is recommended to use CAT5e network cable, which can also be purchased from our company.

### 1-3. EMC

Electromagnetic compatibility (EMC) refers to the ability of electrical equipment to operate normally in its electromagnetic environment without disturbing the environment. The following table describes the standards or specifications that should be followed by all products of L series remote I / O modules.

Electromagnetic compatibility - Immunity	
electrostatic discharge IEC61000-4-2	Contact discharge: $\pm 4\text{kV}$ Air discharge: $\pm 8\text{kV}$
Electrical fast transient burst IEC61000-4-4	Power cable: 2kV, 5kHz Signal cable 2kV, 5kHz (I/O coupling clamp) 1kV, 5Hz (communication coupling clamp)
Surge IEC61000-4-5	Power cable 2kV, 5kHz (asymmetric)

### 1-4. Environmental conditions for transportation, storage and operation

Environmental conditions - transportation and storage	
Temperature	$-40^{\circ}\text{C}\sim 70^{\circ}\text{C}$
Atmospheric pressure	1080hPa~660hPa (the corresponding height is -1000m~+3500m)
Relative humidity	10%~95%RH, no condensation
Environmental conditions - working	
Temperature	Horizontal installation: $0^{\circ}\text{C}\sim 55^{\circ}\text{C}$ Vertical installation: $0^{\circ}\text{C}\sim 40^{\circ}\text{C}$
Atmospheric pressure	1080hPa~795hPa (the corresponding height is -1000m~+2000m)
Relative humidity	10%~95% RH, no condensation
Harsh environment pollutant concentration	Low salt fog, humidity, dust fog and other environments $\text{SO}_2 < 0.5\text{ppm}$ , relative humidity $< 60\%$ RH, no condensation $\text{H}_2\text{S} < 0.1\text{ppm}$ , relative humidity $< 60\%$ RH, no condensation



## 2. LC3-AP adapter module

LC3-AP adapter module supports EtherCAT bus communication protocol and can realize seamless connection with mainstream PLC. A single adapter module can be connected with up to 16 I/O modules and can support up to 512 signal points. A variety of status diagnosis functions and status indicator lights are designed. The screw free terminal is adopted, which is convenient and reliable for wiring, and the oblique 45 degree port is designed to reduce the stress on the port and increase the reliability of the product. Through the dialing buttons on both sides of the module, multiple modules can be fixed to each other to increase the seismic performance of the system. The standard DIN35 guide rail is adopted for installation.

### 2-1. Dimension

(Unit: mm)

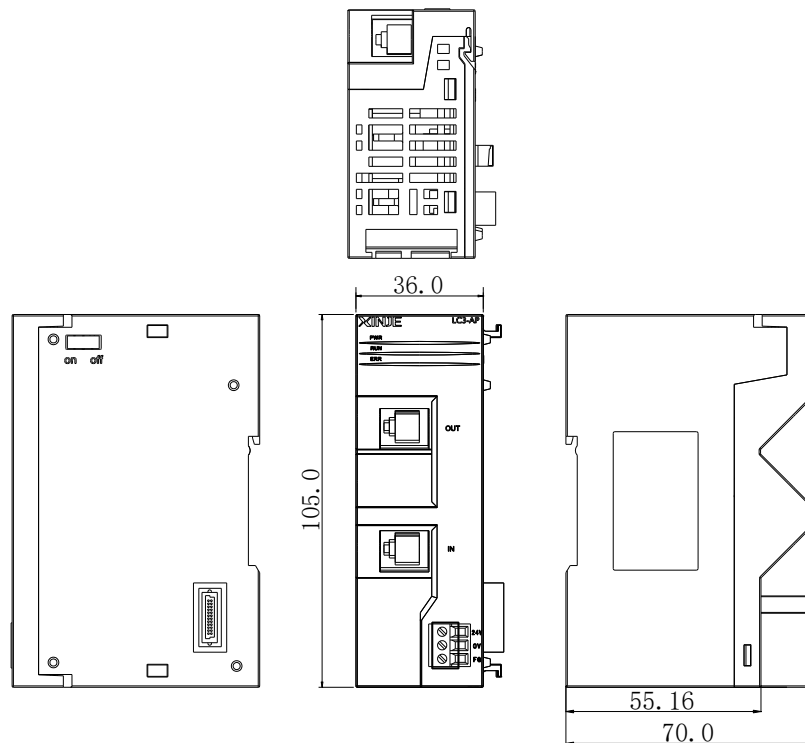

### 2-2. Technical specification

Item		Contents
General	Using environment	No corrosive gas
	Input power supply voltage	DC24V±10%
	Working temperature	0°C~55°C
	Environment humidity	5%~95%RH
	Installation	Directly installed on the guide rail of DIN46277 (35mm wide)
	Ground	The third kind of grounding (not common grounding with strong current system)
Communication	Bus protocol	EtherCAT

	Interface type	Industry Ethernet
	Connection mode	2*RJ45
	Communication speed	100Mb/s
Power supply	Rated voltage	DC24V
	Allowable voltage range	DC21.6V~26.4V
	Input current	120mA DC24V
	Allowable instantaneous power off time	10ms DC24V
	Impulse current	10A DC26.4V

### 2-3. Electrical wiring diagram

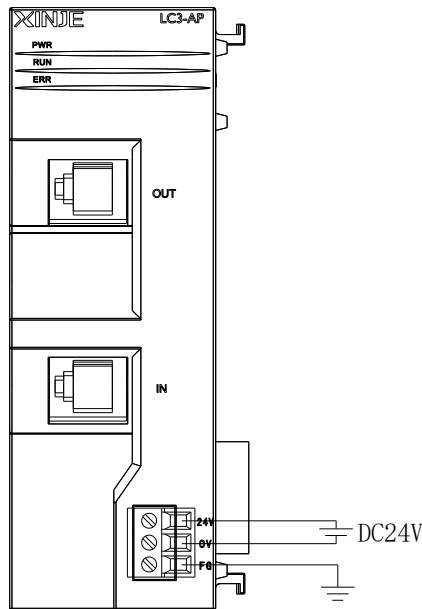

### 2-4. Installation steps

1. Check the installation environment  
Check whether the installation site of special function modules is appropriate.
2. Installation preparation  
Prepare for the installation of special modules.
3. Installation module  
Install the module on the right side of the adapter.
4. Debug  
Check that the module is installed correctly.

Do not install in the following environments:

- (1) Direct sunlight place
- (2) Places where the ambient temperature exceeds 0 ~ 50°C
- (3) Places with ambient humidity exceeding 35 ~ 85% RH
- (4) Places where condensation occurs due to rapid temperature changes

- (5) Places with corrosive and combustible gases
- (6) Places with much dust, salt, iron filings and oil fume
- (7) Places directly affected by vibration and impact
- (8) Places for spraying water, oil, medicine, etc
- (9) Place where strong magnetic field and electric field are generated

Installation requirements:

XL series analog input / output and temperature control module can be installed on the right side of L series adapter and expansion module. DIN46277 guide rail (35mm wide) can be used for installation.

- Install with DIN46277 guide rail

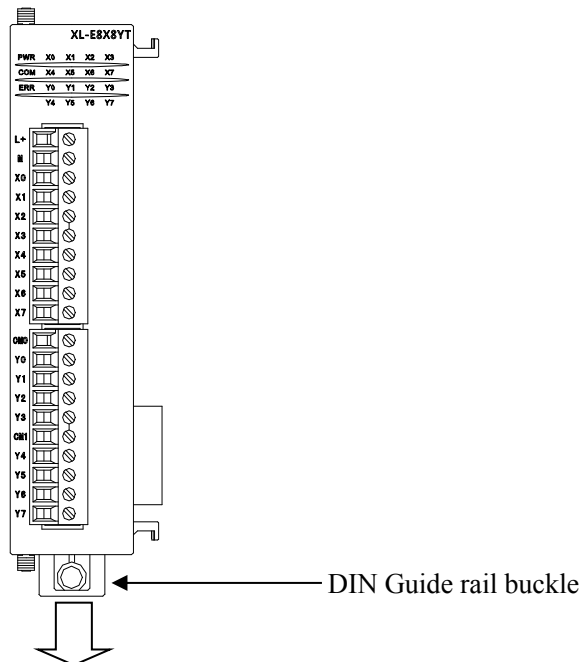

The basic unit and extension module are installed on the guide rail DIN46277mm (width 35mm). For removing, just pull down the assembly hook of DIN rail and remove the product.

Wiring requirements:

Except that XL series 32 point expansion module needs to use external terminal block for wiring, other modules can directly insert the cable into the corresponding wiring hole.

Note:

- ◆ Please confirm the specification and select the appropriate module.
- ◆ During screw hole processing and wiring, please do not let chips and wire chips fall into the module.
- ◆ Before connecting, please reconfirm the specifications of the module and connecting equipment to ensure that there is no problem.
- ◆ When connecting, please pay attention to whether the connection is firm. If the connection falls off, it will cause faults such as incorrect data and short circuit.
- ◆ Installation, wiring and other operations must be carried out after all power supplies are cut off.

### 3. I/O module XL-EnXmY

#### 3-1. Features and specifications

LC3-AP adapter can externally expand XL-EnXmY I/O modules, and each adapter can expand up to 16 modules. With rich types of modules and small shape, it provides the possibility for more input and output points and meets the actual production needs. When using, pay attention to the maximum PDO byte limit of the master station.

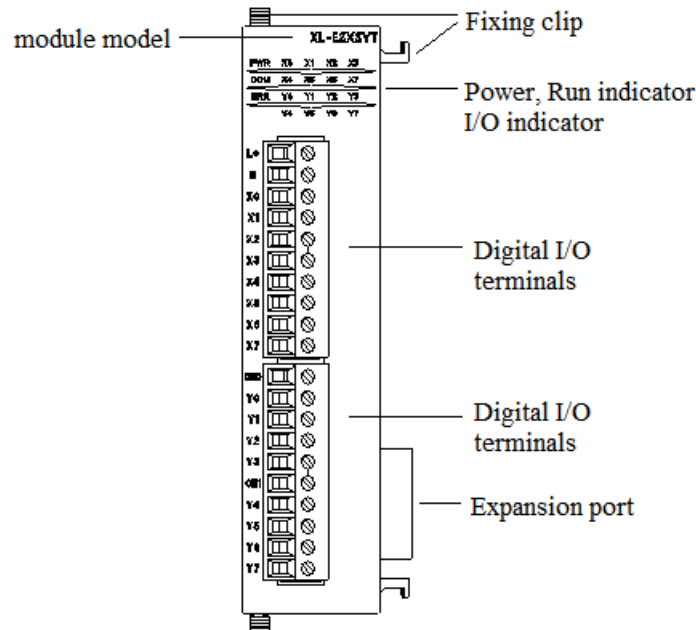

Name		Function
Fixing clip		It is used to fix the adapter and expansion module
Module model		Model of this special function module
Expansion port		Connecting other expansion modules
I/O terminals		The terminal used to connect digital input, output and external equipment, detachable
Power, run indicator	PWR	This indicator is on when the module has power supply
	COM	This indicator is on when the module communication port communicates normally
	ERR	When there is an error in the module, the indicator is always on or flashing (red) When ERR light is always on, it indicates that the module has serious application errors and cannot be used. The use mode must be adjusted, and the PLC body is switched to stop state. When ERR light flashes, it indicates that the module has application error, works abnormally and has abnormal data, but the PLC body is still run.
I/O indicator		Whether the input and output are on indicator

### 3-1-1. Model list

Model		Function	PDO byte number
NPN input	PNP input		
XL-E8X8YR	XL-E8PX8YR	8 channels digital input, 8 channels relay output	2 bytes input, 2 bytes output
XL-E8X8YT	XL-E8PX8YT	8 channels digital input, 8 channels transistor output	2 bytes input, 2 bytes output
XL-E16X	XL-E16PX	16 channels digital input	2 bytes input
XL-E16YR	-	16 channels relay output	2 bytes output
XL-E16YT	-	16 channels transistor output	2 bytes output
XL-E16X16YT-A	XL-E16PX16YT-A	16 channels digital input, 16 channels transistor output	2 bytes input, 2 bytes output
XL-E32X-A	XL-E32PX-A	32 channels digital input	4 bytes input
XL-E32YT-A	-	32 channels transistor output	4 bytes output

### 3-1-2. Module specification

Item	Specification
Input power supply voltage	DC24V±10%
Using environment	No corrosive gas
Ambient temperature	0°C~60°C
Ambient humidity	5~95%
Installation	Directly installed on the guide rail of DIN46277 (width 35mm)

## 3-2. Terminals

- (1) XL-E8X8YR, XL-E8PX8YR, XL-E8X8YT, XL-E8PX8YT terminal blocks are arranged as follows:

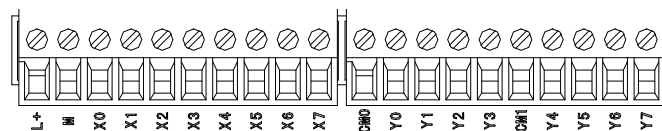

- (2) XL-E16X, XL-E16PX terminal blocks are arranged as follows:

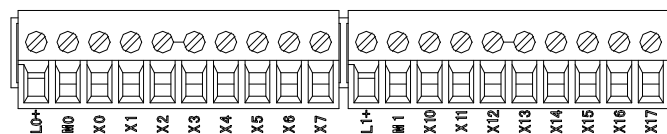

- (3) XL-E16YR, XL-E16YT terminal blocks are arranged as follows:

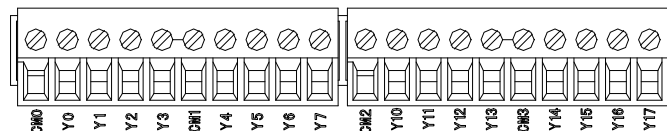

- (4) XL-E16X16YT-A, XL-E16PX16YT-A terminal blocks are arranged as follows:

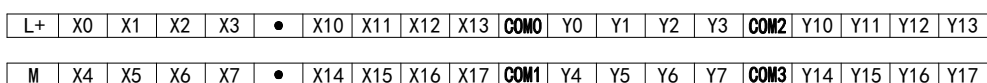

- (5) XL-E32X-A, XL-E32PX-A terminal blocks are arranged as follows:

L+	X0	X1	X2	X3	•	X10	X11	X12	X13	•	X20	X21	X22	X23	•	X30	X31	X32	X33
M	X4	X5	X6	X7	•	X14	X15	X16	X17	•	X24	X25	X26	X27	•	X34	X35	X36	X37

(6) XL-E32YT-A terminal blocks are arranged as follows:

COM0	Y0	Y1	Y2	Y3	COM2	Y10	Y11	Y12	Y13	COM4	Y20	Y21	Y22	Y23	COM6	Y30	Y31	Y32	Y33
COM1	Y4	Y5	Y6	Y7	COM3	Y14	Y15	Y16	Y17	COM5	Y24	Y25	Y26	Y27	COM7	Y34	Y35	Y36	Y37

Note: when connecting the X terminal, external DC24V power supply is required. Please connect 24V + to the L + terminal and 24V - to the M terminal. In addition, the M terminal is also the common terminal of the input point X, and the input and output wiring of the module is the same as that of the L body.

### 3-2-1. Connector specifications

XL-E8X8YR, XL-E8PX8YR, XL-E8X8YT, XL-E8PX8YT, XL-E16X, XL-E16PX, XL-E16YR, XL-E16YT, when wiring the module, its connector shall meet the following requirements:

- (1) Strip length 9mm
- (2) Flexible wire with tubular bare end 0.25-1.5mm<sup>2</sup>
- (3) Flexible wire with tubular pre-insulated ends 0.25-0.5mm<sup>2</sup>

### 3-3. I/O address

The address of the input and output terminals of the XL series expansion module is as follows:

Take XL-E16X16Y module input terminals as an example.

Select the corresponding XY extension module and click IO mapping to view the address mapped by XY. The address starts from HM10000 by default. You only need to control the HM address of XY mapping to control the module input and output.

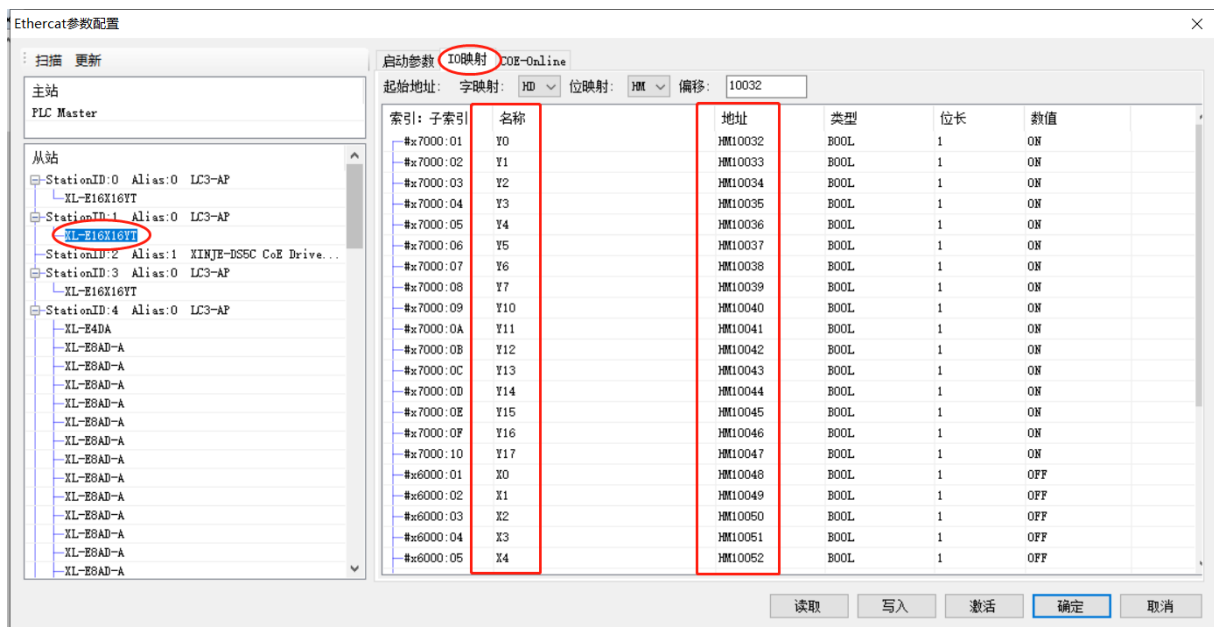

### 3-4. External wiring

#### 3-4-1. Input terminal wiring

##### NPN input wiring

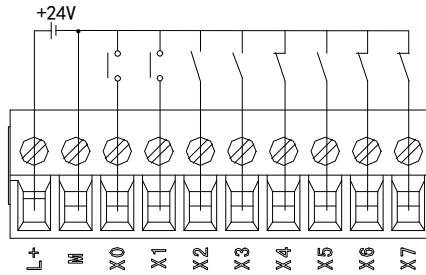

Switch button wiring diagram

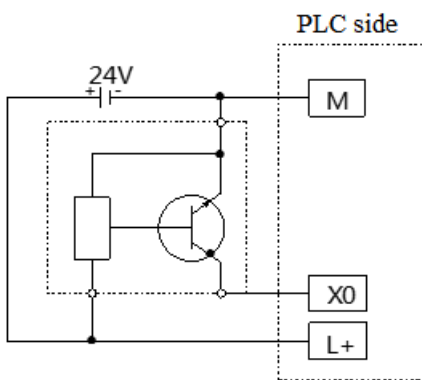

3-wire (NPN) proximity switch wiring diagram

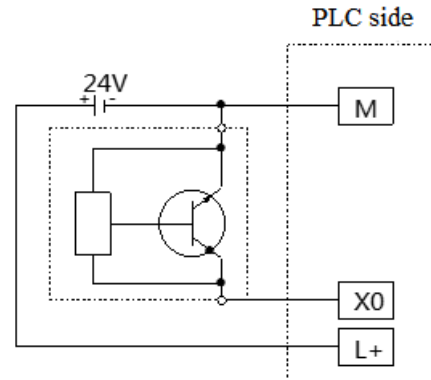

2-wire (NO/NC) proximity switch wiring diagram

##### PNP input terminal wiring

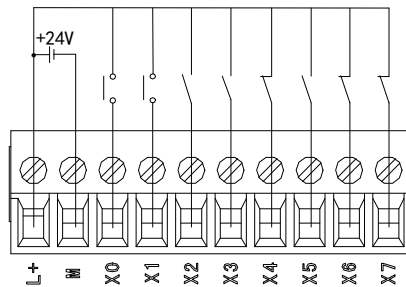

Switch button wiring diagram

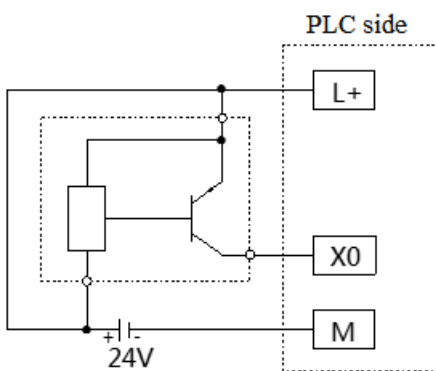

3-wire (PNP) proximity switch wiring diagram

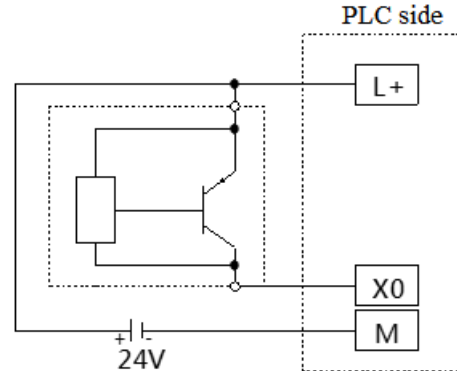

2-wire (NO/NC) proximity switch wiring diagram

### 3-4-2. Output terminal wiring

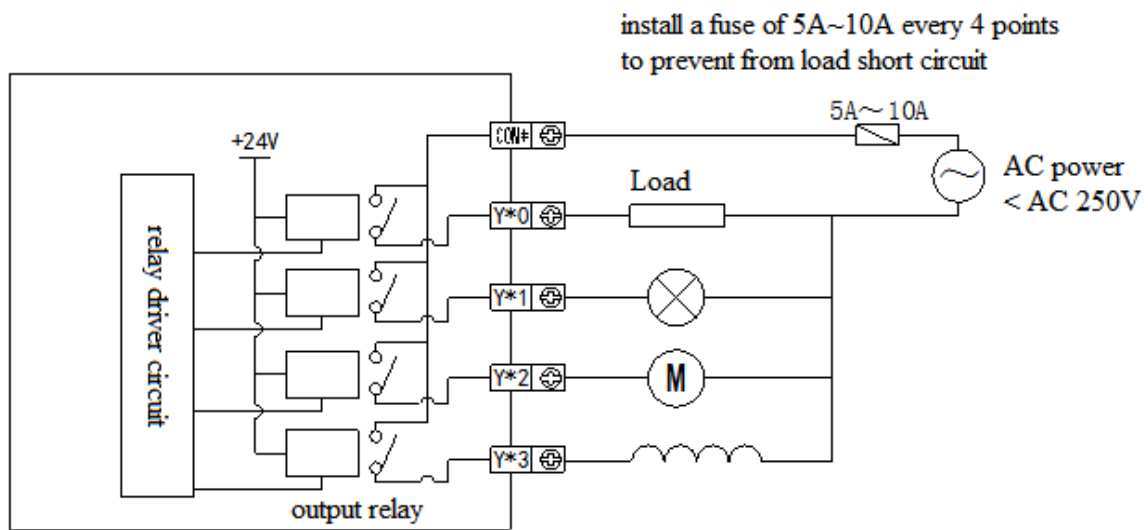

Relay type

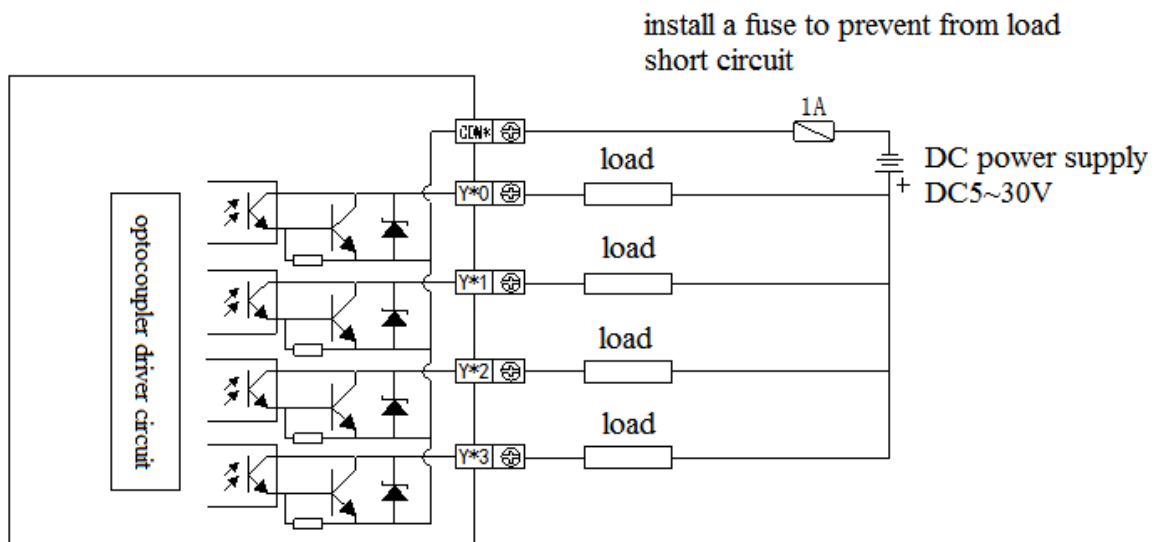

Transistor type

### 3-4-3. External terminal block

XL-E16YT-A, XL-E32X-A, XL-E32PX-A, XL-E16X16YT-A, XL-E16PX16YT-A, XL-E32YT-A need external terminal block. The following is the terminal block and connection cable models.

Module	Terminal block	Adaptive cable
XL-E16YT-A	JT-E16YT-A	JC-TE32-NN05 (0.5m) JC-TE32-NN10 (1.0m) JC-TE32-NN15 (1.5m)
XL-E32X-A	JT-E32X	
XL-E32PX-A		
XL-E16X16YT-A	JT-E16X16YT	
XL-E16PX16YT-A		
XL-E32YT-A	JT-E32YT	



## Terminal block dimension

(Unit: mm)

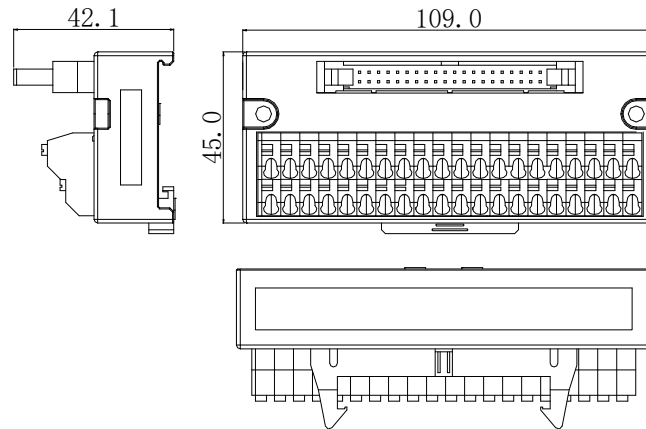

## Terminal block wiring method

When wiring, press the spring switch with a small screw driver, insert the wire into the corresponding socket, and release the spring switch. The terminal block requires the length of wire peeling to be 1.5cm.

## Adaptive cables

When connecting the terminal block externally, it needs to cooperate with the use of connecting cables. Xinje provides JC-TE32-NN05, JC-TE32-NN10, JC-TE32-NN15 cables with different lengths and specifications for users to choose and buy. Please note that when connecting, one end (that the model is wrapped near the transparent heat shrinkable tube) connects with the module, and the other end is connected to the terminal block, which can not be reversed!!!

Wiring diagram:

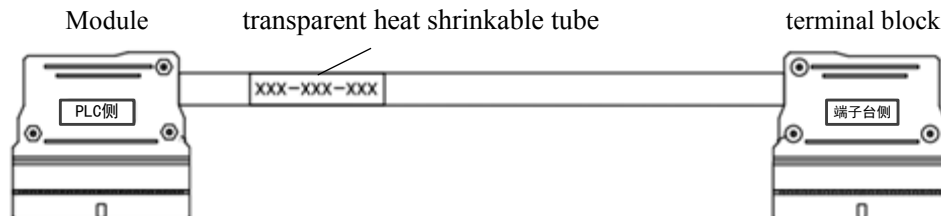

## 3-5. Module parameters

The positive and negative logic is adjustable and the filtering time is adjustable. Taking 16X16Y module as an example, the configuration method is as follows:

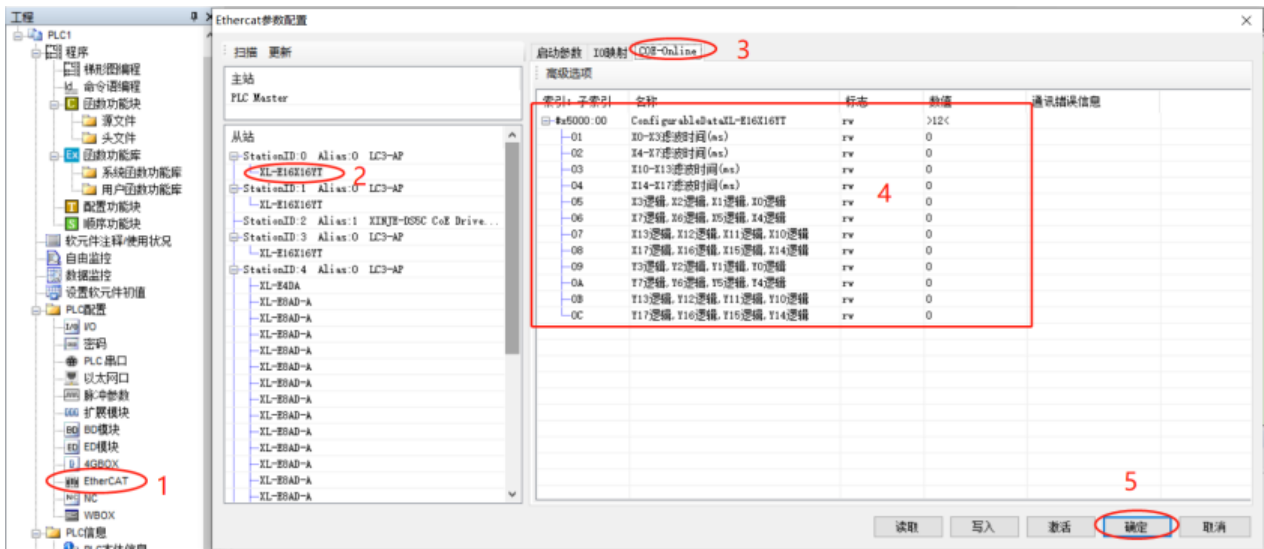

Step 1: click EtherCAT

Step 2: select the module

Step 3: select COE-Online

Step 4: select positive or negative logic and filter time

Step 5: after setting, click ok, then cut the power and power on again for the adapter to make the settings effective

Note: please use the XDPpro software version 3.7.0 and up.

### 3-5-1. #x5000 bit definition

#x5000: the specific allocation of bytes in each module information is as follows:

#### ● XL-E8X8Y

	Byte0	Byte1	Byte2	Byte3	Byte4	Byte5
Bit7	X0~X3 filter time	X4~X7 filter time	-	-	-	-
Bit6			X3 logic	X7 logic	Y3 logic	Y7 logic
Bit5			-	-	-	-
Bit4			X2 logic	X6 logic	Y2 logic	Y6 logic
Bit3			-	-	-	-
Bit2			X1 logic	X5 logic	Y1 logic	Y5 logic
Bit1			-	-	-	-
Bit0			X0 logic	X4 logic	Y0 logic	Y4 logic
Note	Filter time (unit: ms) Setting range: 1~5, 10, 15, 20, 25, 30, 35, 40, 45, 50. Default value is 10		Note: 0 is positive logic, 1 is negative logic			

#### ● XL-E16X

	Byte0	Byte1	Byte2	Byte3	Byte4	Byte5	Byte6	Byte7
Bit7	X0~X3 filter time	X4~X7 filter time	X10~X13 filter time	X14~X17 filter time	-	-	-	-
Bit6					X3 logic	X7 logic	X13 logic	X17 logic
Bit5					-	-	-	-
Bit4					X2 logic	X6 logic	X12 logic	X16 logic
Bit3					-	-	-	-

Bit2					X1 logic	X5 logic	X11 logic	X15 logic
Bit1					-	-	-	-
Bit0					X0 logic	X4 logic	X10 logic	X14 logic
Note	Filter time (unit: ms) Setting range: 1~5, 10, 15, 20, 25, 30, 35, 40, 45, 50. Default value is 10				Note: 0 is positive logic, 1 is negative logic			

● **XL-E16X16Y**

	Bit0	Bit1	Bit2	Bit3	Bit4	Bit5	Bit6	Bit7	Notes
Byte0	X0~X3 filter time								Filter time (unit: ms) Setting range: 1~5, 10, 15, 20, 25, 30, 35, 40, 45, 50. Default value is 10
Byte1	X4~X7 filter time								
Byte2	X10~X13 filter time								
Byte3	X14~X17 filter time								
Byte4	X0 logic	-	X1 logic	-	X2 logic	-	X3 logic	-	Note: 0 is positive logic, 1 is negative logic
Byte5	X4 logic	-	X5 logic	-	X6 logic	-	X7 logic	-	
Byte6	X10 logic	-	X11 logic	-	X12 logic	-	X13 logic	-	
Byte7	X14 logic	-	X15 logic	-	X16 logic	-	X17 logic	-	
Byte8	Y0 logic	-	Y1 logic	-	Y2 logic	-	Y3 logic	-	
Byte9	Y4 logic	-	Y5 logic	-	Y6 logic	-	Y7 logic	-	
Byte10	Y10 logic	-	Y11 logic	-	Y12 logic	-	Y13 logic	-	
Byte11	Y14 logic	-	Y15 logic	-	Y16 logic	-	Y17 logic	-	

● **XL-E16Y/XL-E32Y**

	Bit0	Bit1	Bit2	Bit3	Bit4	Bit5	Bit6	Bit7	Notes
Byte0	Y0 logic	-	Y1 logic	-	Y2 logic	-	Y3 logic	-	Note: 0 is positive logic, 1 is negative logic
Byte1	Y4 logic	-	Y5 logic	-	Y6 logic	-	Y7 logic	-	
Byte2	Y10 logic	-	Y11 logic	-	Y12 logic	-	Y13 logic	-	
Byte3	Y14 logic	-	Y15 logic	-	Y16 logic	-	Y17 logic	-	
Byte4	Y20 logic	-	Y21 logic	-	Y22 logic	-	Y23 logic	-	
Byte5	Y24 logic	-	Y25 logic	-	Y26 logic	-	Y27 logic	-	
Byte6	Y30 logic	-	Y31 logic	-	Y32 logic	-	Y33 logic	-	
Byte7	Y34 logic	-	Y35 logic	-	Y36 logic	-	Y37 logic	-	

● **XL-E32X**

	Bit0	Bit1	Bit2	Bit3	Bit4	Bit5	Bit6	Bit7	Note
Byte0	X0~X3 filter time								Filter time (unit: ms) Setting range: 1~5, 10, 15, 20, 25, 30, 35, 40, 45, 50. Default value is 10
Byte1	X4~X7 filter time								
Byte2	X10~X13 filter time								
Byte3	X14~X17 filter time								
Byte4	X20~X23 filter time								
Byte5	X24~X27 filter time								

	Bit0	Bit1	Bit2	Bit3	Bit4	Bit5	Bit6	Bit7	Note
Byte6	X30~X33 filter time								Note: 0 is positive logic, 1 is negative logic
Byte7	X34~X37 filter time								
Byte8	X0 logic	-	X1 logic	-	X2 logic	-	X3 logic	-	
Byte9	X4 logic	-	X5 logic	-	X6 logic	-	X7 logic	-	
Byte10	X10 logic	-	X11 logic	-	X12 logic	-	X13 logic	-	
Byte11	X14 logic	-	X15 logic	-	X16 logic	-	X17 logic	-	
Byte12	X20 logic	-	X21 logic	-	X22 logic	-	X23 logic	-	
Byte13	X24 logic	-	X25 logic	-	X26 logic	-	X27 logic	-	
Byte14	X30 logic	-	X31 logic	-	X32 logic	-	X33 logic	-	
Byte15	X34 logic	-	X35 logic	-	X36 logic	-	X37 logic	-	

**Note:**

In case of positive logic, the input terminal X is on, the X terminal signal is on, the input terminal X is off, and the X terminal signal is off.

In case of negative logic, the input terminal X is on, the X terminal signal is off, the input terminal X is off, and the X terminal signal is on.

The default is positive logic, which generally does not need to be modified.

### 3-6. Dimension

Please refer to the following figure for the outline and dimensions of XL series 8 ~ 16 points I/O module:

(Unit: mm)

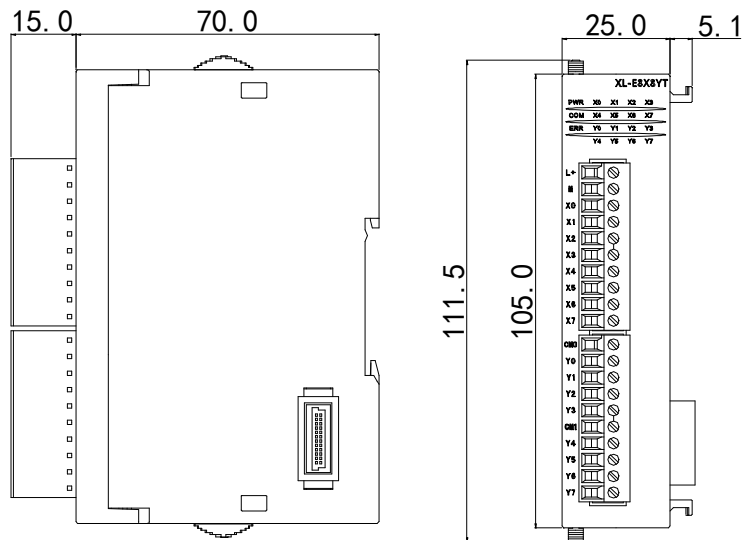

Please refer to the figure below for the outline and dimensions of XL series 32 points I/O module:  
(unit: mm)

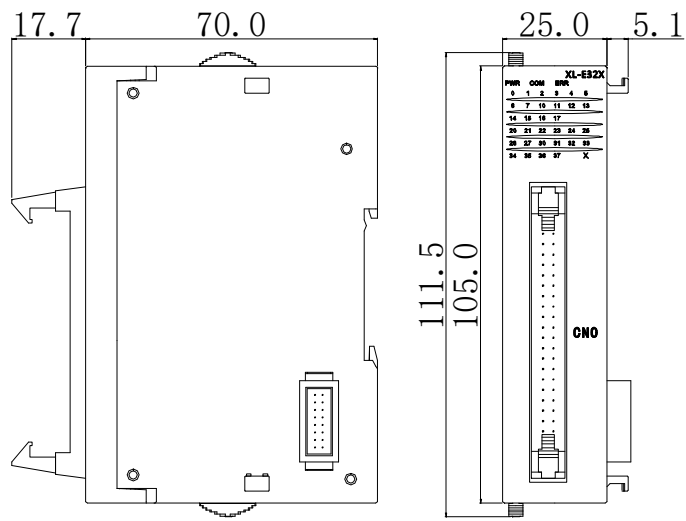

## 4. Analog I/O module XL-E4AD2DA

### 4-1. Features and specification

XL-E4AD2DA analog input and output module converts 4 analog input values into digital values and 2 digital values into analog values, and transmits them to the PLC main unit for real-time data interaction with the PLC main unit.

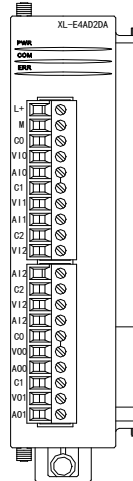

#### 4-1-1. Features

- 4-channel analog input: voltage input or current input is optional
- 14 bits high-precision analog input
- 2-channel 12 bits analog output
- As a L series expansion module, LC3-AP adapter can connect up to 16 modules
- Output 6 bytes and input 36 bytes, a total of 42 bytes. When using, pay attention to the maximum PDO byte limit of the master station.

#### 4-1-2. Specification

Item	Analog input		Analog output	
	Voltage input	Current input	Voltage output	Current output
Analog input	0~5V, 0~10V -5~5V, -10~10V	0~20mA, 4~20mA, -20~20mA	-	
Max input range	DC±15V		-	
Analog output	-		0~5V, 0~10V -5~5V, -10~10V (external load resistor 2KΩ~1MΩ)	0~20mA, 4~20mA (external load resistor less than 500Ω)
Digital input	-		12-bit binary value (0~4095 or -2048~2047)	
Digital output	14-bit binary value (0~16383 or -8192~8191)		-	
Resolution	1/16383 (14-Bit)		1/4095 (12-Bit)	
Comprehensive accuracy	1%			
Conversion speed	2ms/channel		2ms/channel	
Module power	DC24V±10%, 150mA			

supply	
Installation mode	Directly installed on the guide rail of DIN46277 (width 35mm)

## 4-2. Terminals

### 4-2-1. Terminal arrangement

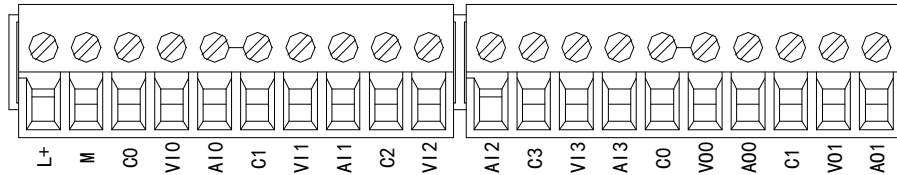

### 4-2-2. Terminal signals

Name	Function	
Indicator	PWR	This indicator is on when the module has power supply
	COM	This indicator is on when the module communication port communicates normally
	ERR	When there is an error in the module, the indicator is always on or flashing (red) When ERR light is always on, it indicates that the module has serious application errors and cannot be used. The use mode must be adjusted, and the PLC body is switched to stop state. When ERR light flashes, it indicates that the module has application error, works abnormally and has abnormal data, but the PLC body is still run.
Terminals	L+	External power supply DC24V+
	M	External power supply DC24V -
	C0	VI0, AI0 input ground
	VI0	Channel 1 AD voltage input
	AI0	Channel 1 AD current input
	C1	VI1, AI1 input ground
	VI1	Channel 2 AD voltage input
	AI1	Channel 2 AD current input
	C2	VI2, AI2 input ground
	VI2	Channel 3 AD voltage input
	AI2	Channel 3 AD current input
	C3	VI3, AI3 input ground
	VI3	Channel 4 AD voltage input
	AI3	Channel 4 AD current input
	C0	VO0, AO0 output ground
	VO0	Channel 1 DA voltage output
	AO0	Channel 1 DA current output
	C1	VO1, AO1 output ground
VO1	Channel 2 DA voltage output	
AO1	Channel 2 DA current output	

### 4-2-3. Wire connector specification

When wiring the module, its connector shall meet the following requirements:

- (1) Stripping length 9mm
- (2) Flexible wire with tubular bare end 0.25-1.5mm<sup>2</sup>
- (3) Flexible wire with tubular pre-insulated end 0.25-0.5mm<sup>2</sup>

### 4-3. I/O address

XL series analog module does not occupy the I/O unit, and the converted value is directly sent to the mapped register address. The register definition number corresponding to the channel is as follows:

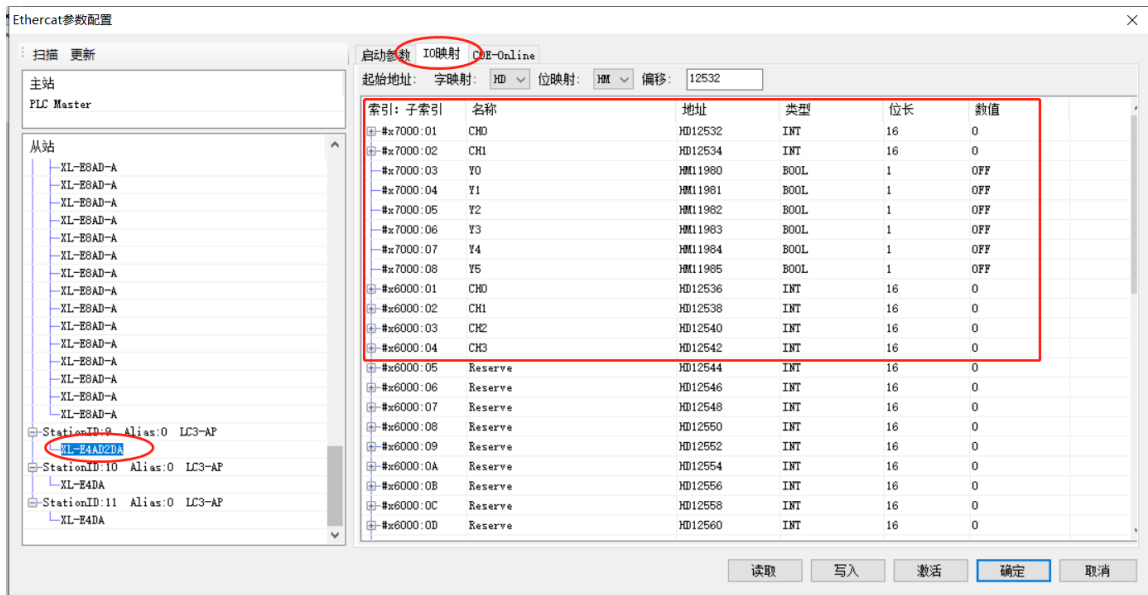

0x6000: input data. The object dictionary index of the input data of module 1 is 0x6000, 0x6010 for module 2, and so on.

0x7000: output data. The object dictionary index of the input data of module 1 is 0x7000, 0x7010 for module 2, and so on.

#### IO mapping register definition: (take above figure as an example)

Channel	AD signal mapping address	Enable bit of channel (turn on the enable bit to use this channel)	Mapping address
CH0	HD12536	Y0	HM11980
CH1	HD12538	Y1	HM11981
CH2	HD12540	Y2	HM11982
CH3	HD12542	Y3	HM11983
Channel	DA signal mapping address	Enable bit of channel (turn on the enable bit to use this channel)	Mapping address
CH0	HD12532	Y4	HM11984
CH0	HD12534	Y5	HM11985

#### Note:

- (1) Disabling unused channels can improve the scanning speed of input/output.
- (2) When the enable bit of input channel is turned off during operation, the corresponding input channel will not collect data. (the data is displayed as 0).
- (3) When the enable bit of the output channel is turned off during operation, the corresponding output channel keeps the original data unchanged.
- (4) The address of the module mapping is not fixed. It starts from the first module 10000 and continues.



## 4-4. Working mode

### 4-4-1. Configuration panel

Please use XDPpro software V3.7.0 and up to set the parameters.

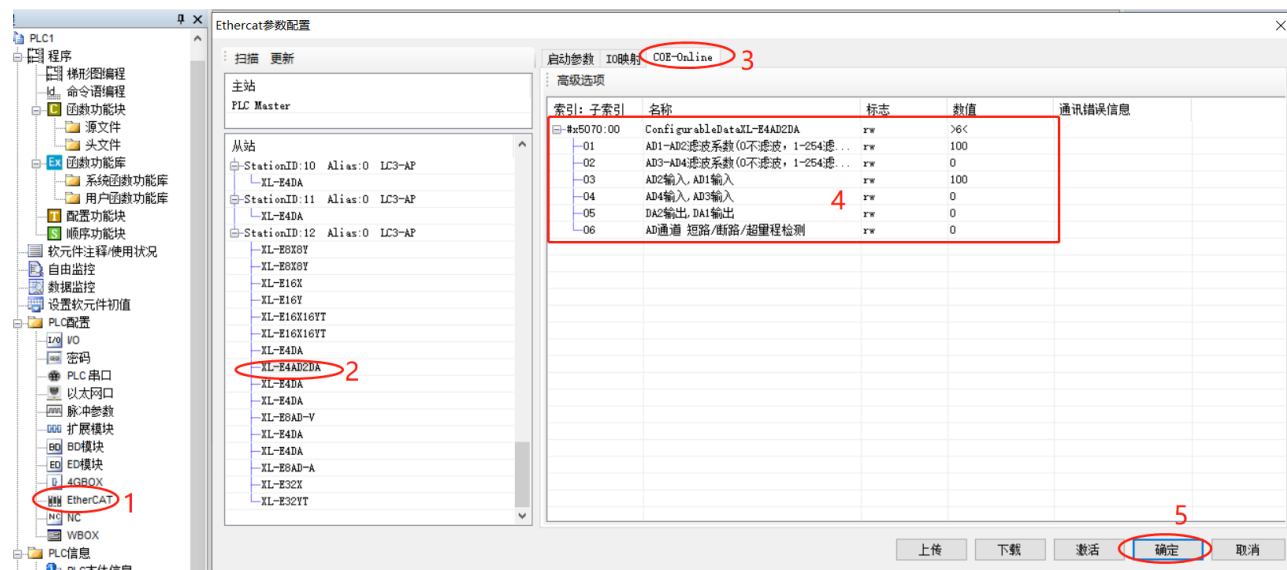

Step 1: click EtherCAT

Step 2: choose the module

Step 3: click COE-Online

Step 4: set the AD filter coefficient, AD/DA channel voltage/current mode. Please check the bit definition of #x5000.

Step 5: after setting, click ok, then cut the power and power on again for the adapter to make the settings effective.

Note: The first-order low-pass filtering method uses this sampling value and the last filtering output value to weight to obtain the effective filtering value. The filter coefficient is set to 0 ~ 254 by the user. The smaller the value, the more stable the data is, but it may lead to data lag. Therefore, when set to 1, the filtering effect is the strongest and the data is the most stable. When set to 254, the filtering effect is the weakest. The default is 0 (no filtering).

### 4-4-2. Bit definition of #x5000

Take XL-E4AD2DA as an example to explain the setting method.

	Bit7	Bit6	Bit5	Bit4	Bit3	Bit2	Bit1	Bit0	Note	
Byte1	AD channel 1, 2 filter coefficient								AD filter coefficient	
Byte2	AD channel 3, 4 filter coefficient									
Byte3	Bit7	Bit6	Bit5	Bit4	Bit3	Bit2	Bit1	Bit0	It is used to specify the input range of AD and DA modules. The lower 4 bits of 03 are the setting bits of AD channel 1 and the	
	AD2				AD1					
	-	000: 0~10V 010: 0~20mA		-		000: 0~10V 010: 0~20mA				
		001: 0~5V 011: 4~20mA				001: 0~5V 011: 4~20mA				
	100: -10~10V 110: -20~20mA				100: -10~10V 110: -20~20mA					
	101: -5~5V				101: -5~5V					
Byte4	Bit7	Bit6	Bit5	Bit4	Bit3	Bit2	Bit1	Bit0	channel 1 and the	
	AD4				AD3					

	-	000: 0~10V 001: 0~5V 100: -10~10V 101: -5~5V	010: 0~20mA 011: 4~20mA 110: -20~20mA	-	000: 0~10V 001: 0~5V 100: -10~10V 101: -5~5V	010: 0~20mA 011: 4~20mA 110: -20~20mA	upper 4 bits are the setting bits of AD channel 2. 04 lower 4 bits are AD channel 3 setting. The upper 4 bits are the setting bits of AD channel 4. The lower 4 bits of 05 are the setting bits of DA channel 1 and the upper 4 bits are the setting bits of DA channel 2.	
Byte5	Bit7	Bit6	Bit5	Bit4	Bit3	Bit2	Bit1	Bit0
	DA2				DA1			
	-	000: 0~10V 001: 0~5V 100: -10~10V 101: -5~5V	010: 0~20mA 011: 4~20mA	-	000: 0~10V 001: 0~5V 100: -10~10V 101: -5~5V	010: 0~20mA 011: 4~20mA		
Byte6	AD channel short circuit / open circuit / overtravel detection							

For example: to set the working modes of input channels AD1, AD2, AD3 and AD4 of the first module as 0 ~ 20mA, 4 ~ 20mA, 0 ~ 10V and 0 ~ 5V respectively, the filter coefficient of AD channel 1 and channel 2 is set as 254, and the filter coefficient of AD channel 3 and channel 4 is set as 100. The working modes of output DA1 and DA2 channels are 0 ~ 10V and 0 ~ 20mA respectively.

≡#x5070:00	ConfigurableDataXL-E4AD2DA	rw	>6<	
01	AD1~AD2滤波系数(0不滤波, 1~254滤...	rw	254	AD1~AD2 Filter coefficient
02	AD3~AD4滤波系数(0不滤波, 1~254滤...	rw	100	AD3~AD4 Filter coefficient
03	AD2输入, AD1输入	rw	50	AD2 input, AD1 input
04	AD4输入, AD3输入	rw	16	AD4 input AD3 input
05	DA2输出, DA1输出	rw	32	DA2 output, DA1 output
06	AD通道 短路/断路/超量程检测	rw	0	AD channel short circuit/open circuit/overtravel detection

As shown in the figure, AD2 input and AD1 input are displayed as decimal 50 and converted to binary as 00110010. AD1 corresponds to 0010 working mode of 0 ~ 20mA, and AD2 corresponds to 0011 working mode of 4 ~ 20mA.

## 4-5. External wiring

During external connection, in order to avoid interference, please use shielded wire and ground the shielding layer at a single point.

### 4-5-1. Voltage single end input

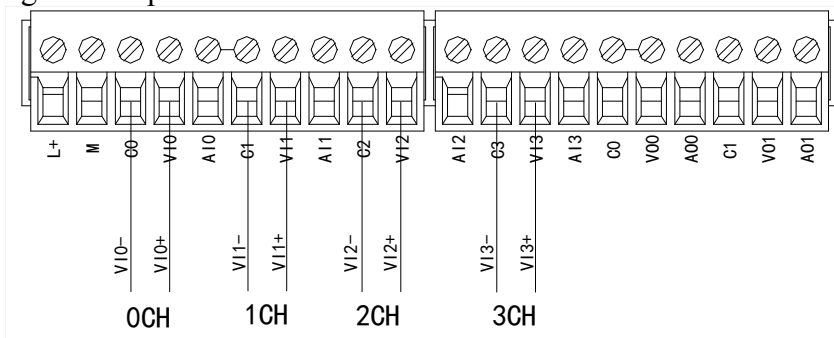

#### 4-5-2. Voltage single end output

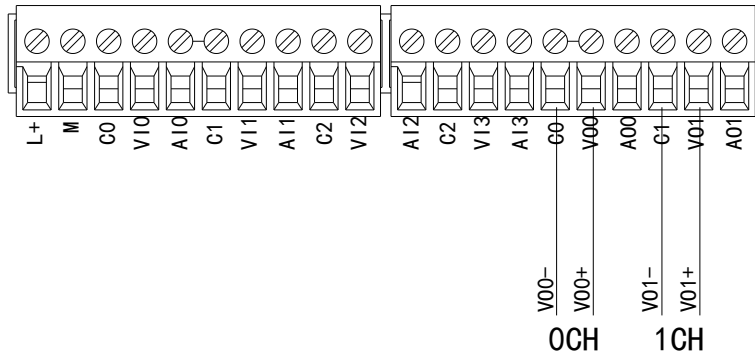

#### 4-5-3. Current single end input

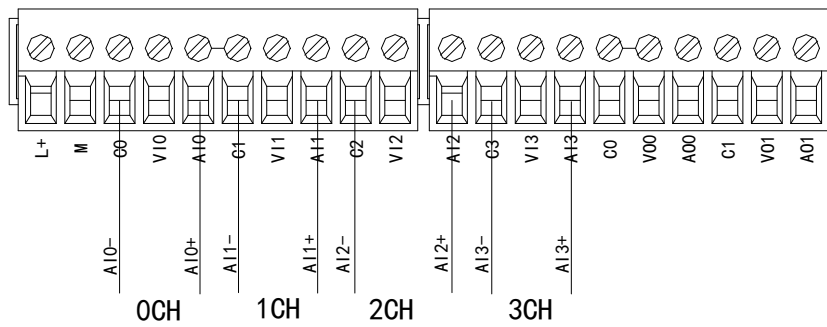

The wiring of XL-E4AD2DA current input side is shown in the figure below:

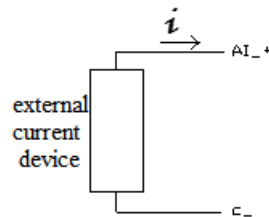

#### 4-5-4. Current single end output

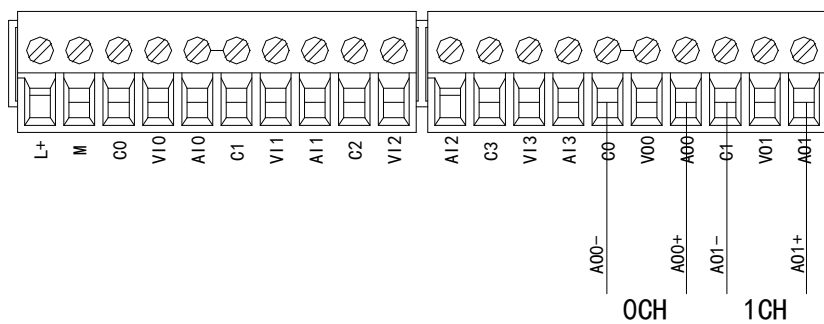

Note: current output no need to connect the DC24V power supply!

## 4-6. AD conversion diagram

The relationship between input analog quantity and converted digital quantity is shown in the table below:

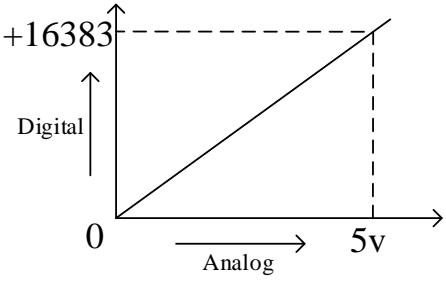
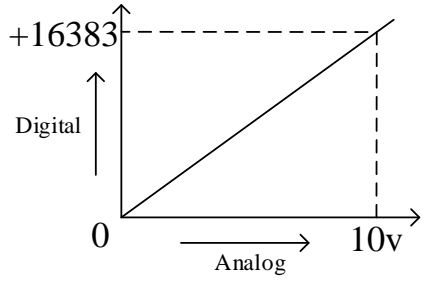
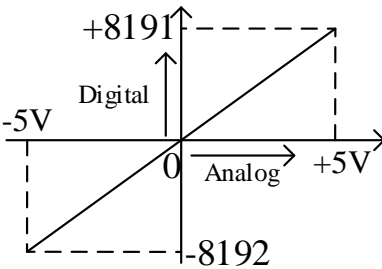
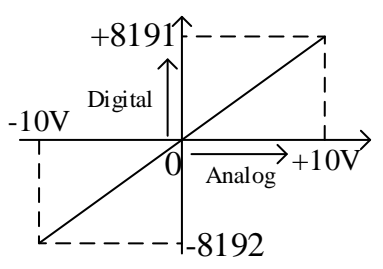
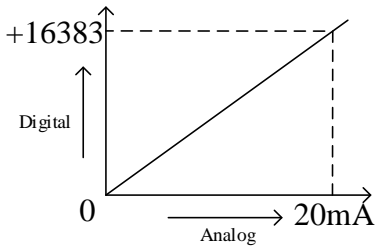
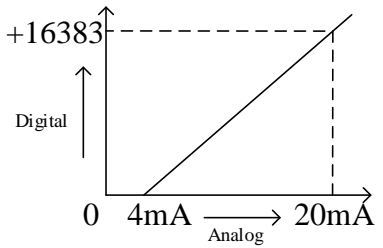
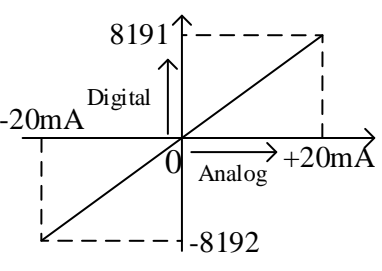
<p style="text-align: center;">0~5V analog input</p> 	<p style="text-align: center;">0~10V analog input</p> 
<p style="text-align: center;">-5~5V analog input</p> 	<p style="text-align: center;">-10~10V analog input</p> 
<p style="text-align: center;">0~20mA analog input</p> 	<p style="text-align: center;">4~20mA analog input</p> 
<p style="text-align: center;">-20~20mA analog input</p> 	

The relationship between the output digital quantity and its corresponding analog quantity data is shown in the table below:

0~5V analog output	0~10V analog output
-5~5V analog output	-10~10V analog output
0~20mA analog output	4~20mA analog output

**Note:**

- (1) When the AD voltage input is suspended, the corresponding ID register is displayed as 16383. When the AD current input is suspended, the corresponding ID register is displayed as 0.
- (2) When the input data exceeds K4095, the analog data converted by DA remains unchanged at 5V, 10V or 20mA.

4-7. Dimension

(Unit: mm)

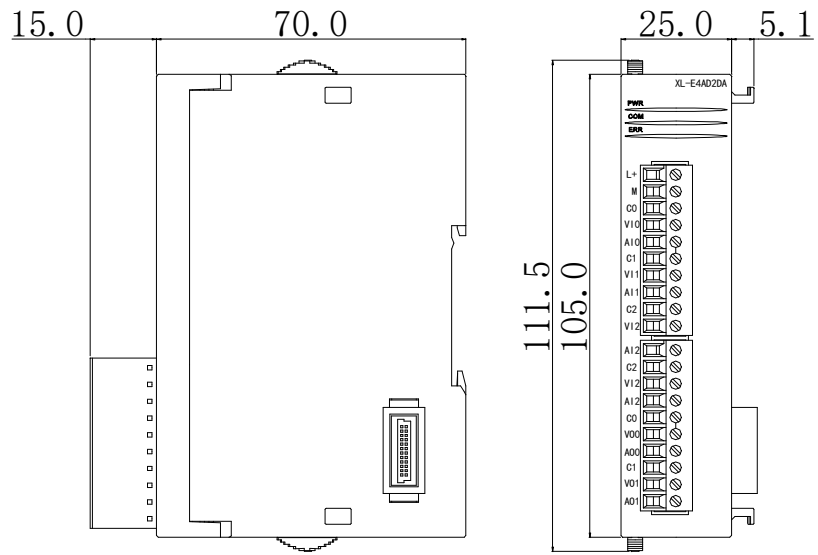

## 5. Analog input module XL-E8AD-A

### 5-1. Features and specifications

XL-E8AD-A analog input module converts 8 analog current input values into digital values, transmits them to PLC main unit, and carries out real-time data interaction with PLC main unit.

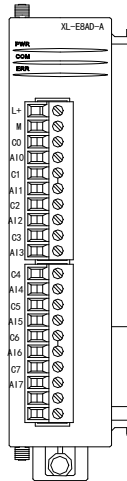

#### 5-1-1. Features

- 8-channel analog input: current input.
- 14-bit high-precision analog input.
- As an L series expansion module, LC3-AP adapter can connect up to 16 modules.
- Output 2 bytes and input 34 bytes, a total of 36 bytes. When using, pay attention to the maximum PDO byte limit of the master station.

#### 5-1-2. Specifications

Item	Analog input
	Current input
Analog input range	0~20mA, 4~20mA, -20~20mA
Max input range	-40~40mA
Digital output range	14-bit binary value (0~16383 or -8192~8191)
Resolution	1/16383 (14-Bit)
Comprehensive accuracy	1%
Conversion speed	2ms/channel
Module power supply	DC24V±10%, 150mA
Installation mode	It is directly installed on the guide rail of DIN46277 (width 35mm)

## 5-2. Terminals

### 5-2-1. Terminal arrangement

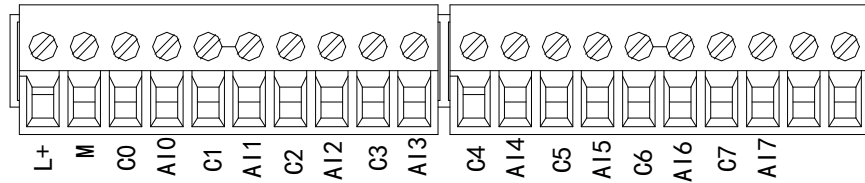

### 5-2-2. Terminal signals

Name		Function
Indicator	PWR	When the module is connected to the power supply, the indicator is always on (green)
	COM	When the module communication port communicates normally, the indicator light is on (green)
	ERR	When there is an error in the module, the indicator is always on or flashing (red) When ERR light is always on, it indicates that the module has serious application errors and cannot be used. The use mode must be adjusted, and the PLC body is switched to stop state. When ERR light flashes, it indicates that the module has application error, works abnormally and has abnormal data, but the PLC body is still run.
Wiring terminals	L+	External power supply DC24V +
	M	External power supply DC24V -
	C0	AI0 input ground
	AI0	Channel 1 AD current input
	C1	AI1 input ground
	AI1	Channel 2 AD current input
	C2	AI2 input ground
	AI2	Channel 3 AD current input
	C3	AI3 input ground
	AI3	Channel 4 AD current input
	C4	AI4 input ground
	AI4	Channel 5 AD current input
	C5	AI5 input ground
	AI5	Channel 6 AD current input
	C6	AI6 input ground
AI6	Channel 7 AD current input	
C7	AI7 input ground	
AI7	Channel 8 AD current input	

### 5-2-3. Wire connector specification

When wiring the module, its connector shall meet the following requirements:

- (1) Stripping length 9mm
- (2) Flexible wire with tubular bare end 0.25-1.5mm<sup>2</sup>
- (3) Flexible wire with tubular pre-insulated end 0.25-0.5mm<sup>2</sup>



### 5-3. I/O address

XL series analog module does not occupy the I/O unit, and the converted value is directly sent to the PLC register. The PLC register definition number corresponding to the channel is as follows:

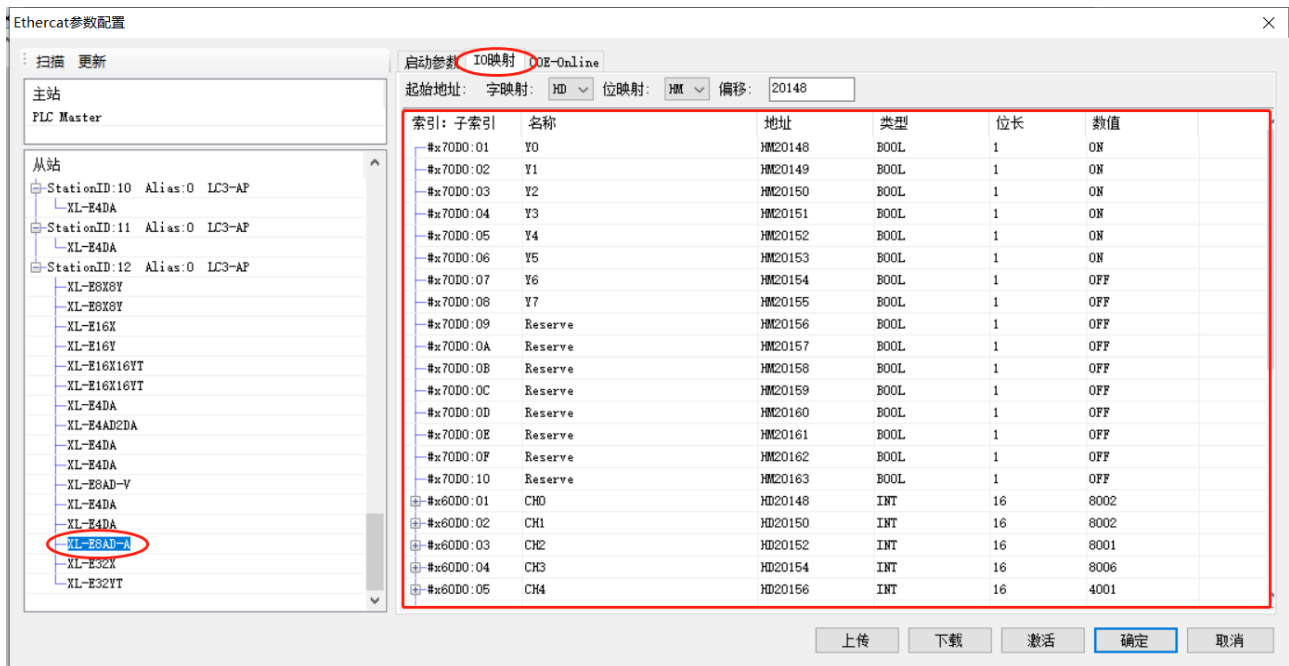

#x60D0:05	CH4	HD20156	INT	16	4001
#x60D0:06	CH5	HD20158	INT	16	4001
#x60D0:07	CH6	HD20160	INT	16	0
#x60D0:08	CH7	HD20162	INT	16	0

Note: the reserve channel is a reserved channel, which has no practical significance

#### Definition number of IO mapping register: (only take above figure as an example)

Channel	AD signal mapping address	Enable bit of the channel (Set ON the enable bit to use this channel)	Mapping address
CH0	HD20148	Y0	HM20148
CH1	HD20150	Y1	HM20149
CH2	HD20152	Y2	HM20150
CH3	HD20154	Y3	HM20151
CH4	HD20156	Y4	HM20152
CH5	HD20158	Y5	HM20153
CH6	HD20160	Y6	HM20154
CH7	HD20162	Y7	HM20155

#### Note:

- (1) Disabling unused channels can improve the scanning speed of input/output.
- (2) When the input enable bit is turned off during operation, the corresponding input channel will not collect data. (data is displayed as 0)
- (3) The address of the module mapping is not fixed. It starts from the first module 10000 and continues.

## 5-4. Working mode

### 5-4-1. Configuration panel

Please use XDPpro software V3.7.0 and up to configure the module.

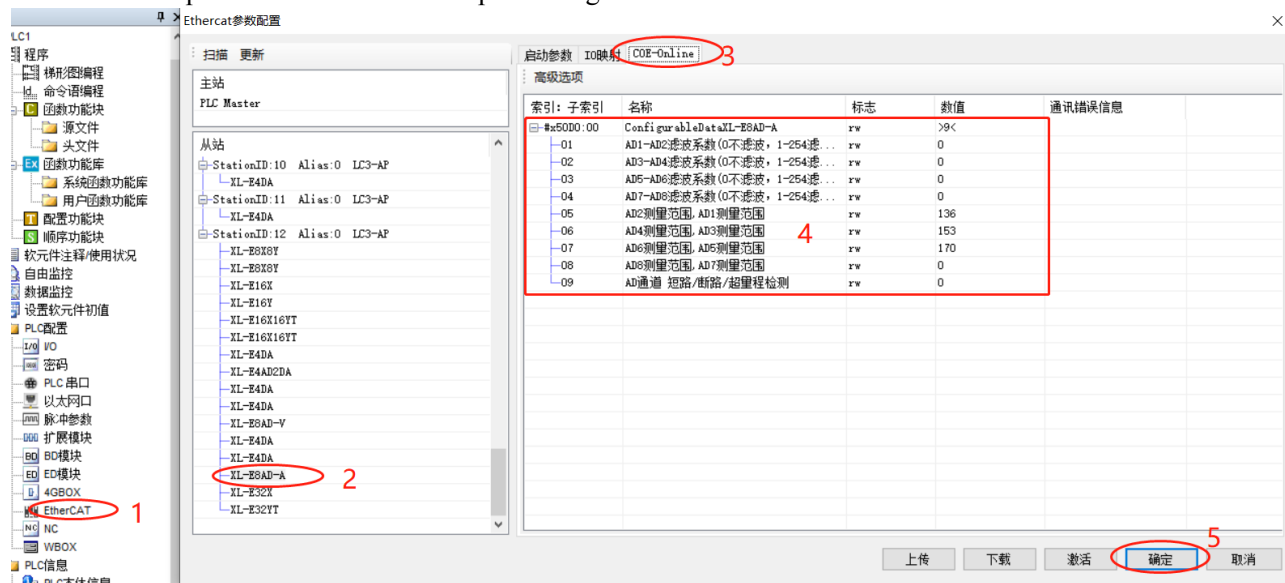

Step 1: click EtherCAT

Step 2: choose the module

Step 3: click COE-Online

Step 4: set the AD filter coefficient, AD channel current mode. Please check the bit definition of #x5000.

Step 5: after setting, click ok, then cut the power and power on again for the adapter to make the settings effective.

Note: The first-order low-pass filtering method uses this sampling value and the last filtering output value to weight to obtain the effective filtering value. The filter coefficient is set to 0 ~ 254 by the user. The smaller the value, the more stable the data is, but it may lead to data lag. Therefore, when set to 1, the filtering effect is the strongest and the data is the most stable. When set to 254, the filtering effect is the weakest. The default is 0 (no filtering).

### 5-4-2. #x5000 bit definition

The input channel of the expansion module is in current mode, with options of 0 ~ 20mA, 4 ~ 20mA and - 20 ~ 20mA, which can be set through #x5000. As follows:

	Bit7	Bit6	Bit5	Bit4	Bit3	Bit2	Bit1	Bit0	Note
Byte0	AD channel 2, 1 filter coefficient								AD filter coefficient
Byte1	AD channel 4, 3 filter coefficient								
Byte2	AD channel 6, 5 filter coefficient								
Byte3	AD channel 8, 7 filter coefficient								
Byte4	Bit7	Bit6	Bit5	Bit4	Bit3	Bit2	Bit1	Bit0	to specify the input range of the AD module, 05 lower 4 bits are the setting bits of AD channel 1, and the upper 4 bits are the setting bits of AD channel 2.
	AD2				AD1				
	1000: current 0~20mA 1001: current 4~20mA 1010: current -20~20mA				1000: current 0~20mA 1001: current 4~20mA 1010: current -20~20mA				
Byte5	Bit7	Bit6	Bit5	Bit4	Bit3	Bit2	Bit1	Bit0	
	AD4				AD3				

	1000: current 0~20mA 1001: current 4~20mA 1010: current -20~20mA				1000: current 0~20mA 1001: current 4~20mA 1010: current -20~20mA				06 lower 4 bits are the setting bits of AD channel 3, and the upper 4 bits are the setting bits of AD channel 4.  07 lower 4 bits are the setting bits of AD channel 5, and the upper 4 bits are the setting bits of AD channel 6  08 lower 4 bits are the setting bits of AD channel 7 and the upper 4 bits are the setting bits of AD channel 8.
Byte6	Bit7	Bit6	Bit5	Bit4	Bit3	Bit2	Bit1	Bit0	
	AD6				AD5				
	1000: current 0~20mA 1001: current 4~20mA 1010: current -20~20mA				1000: current 0~20mA 1001: current 4~20mA 1010: current -20~20mA				
Byte7	Bit7	Bit6	Bit5	Bit4	Bit3	Bit2	Bit1	Bit0	
	AD8				AD7				
	1000: current 0~20mA 1001: current 4~20mA 1010: current -20~20mA				1000: current 0~20mA 1001: current 4~20mA 1010: current -20~20mA				
Byte8	AD channel short circuit / open circuit / overtravel detection								

## 5-5. External wiring

During external connection, in order to avoid interference, please use shielded wire and ground the shielding layer at a single point.

### 5-5-1. Current single end input

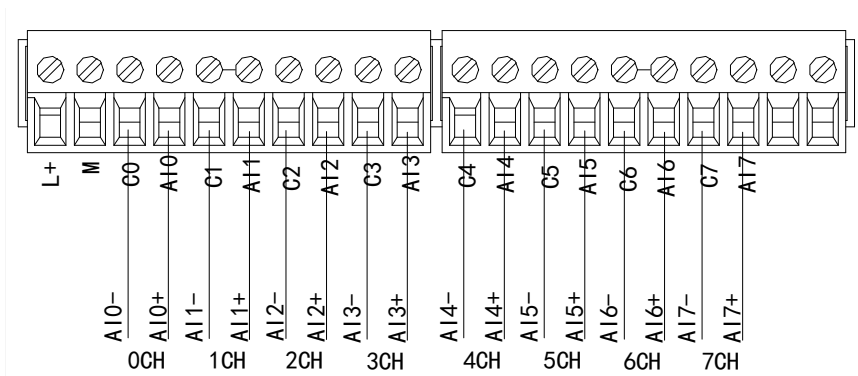

XL-E8AD-A current input wiring diagram:

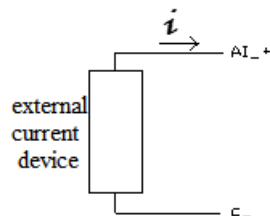

## 5-6. Analog digital conversion diagram

The relationship between input analog quantity and converted digital quantity is shown in the table below:

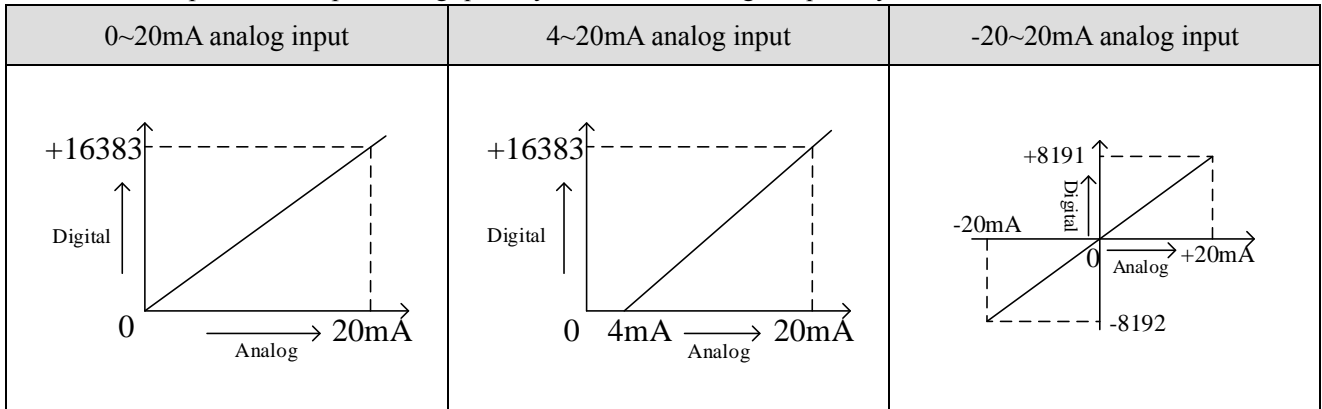

## 5-7. Dimension

(Unit: mm)

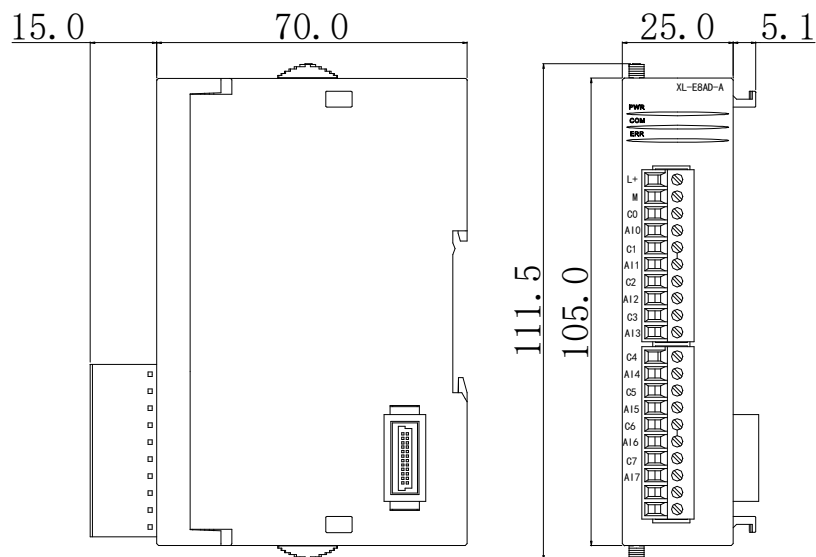

## 6. Analog input module XL-E8AD-V

### 6-1. Features and specification

XL-E8AD-V analog input module converts 8 analog input values into digital values, transmits them to PLC main unit, and carries out real-time data interaction with PLC main unit.

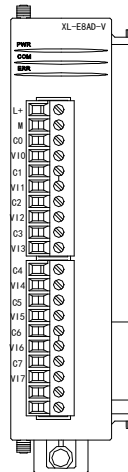

#### 6-1-1. Features

- 8-channel analog input: voltage input.
- 14 bits high-precision analog input.
- As an L series expansion module, LC3-AP adapter can connect up to 16 modules.
- Output 2 bytes and input 34 bytes, a total of 36 bytes. Pay attention to the maximum PDO byte limit of the master station when using.

#### 6-1-2. Specification

Item	Analog input
	Voltage input
Analog input range	0~5V, 0~10V, -5~5V, -10~10V
Max input range	DC±15V
Digital output range	14-bit binary value (0~16383 or -8192~8191)
Resolution	1/16383 (14-Bit)
Comprehensive accuracy	1%
Conversion speed	2ms/channel
Module power supply	DC24V±10%, 150mA
Installation method	It is directly installed on the guide rail of DIN46277 (width 35mm)

## 6-2. Terminals

### 6-2-1. Terminal arrangement

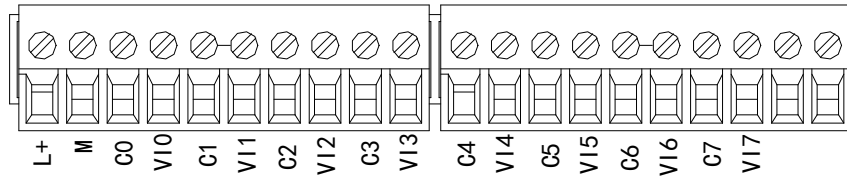

### 6-2-2. Terminal signals

Name		Function
Indicator	PWR	When the module is connected to the power supply, the indicator is always on (green)
	COM	When the module communication port communicates normally, the indicator light is on (green)
	ERR	When there is an error in the module, the indicator is always on or flashing (red) When ERR light is always on, it indicates that the module has serious application errors and cannot be used. The use mode must be adjusted, and the PLC body is switched to stop state. When ERR flashes, it indicates that the module has application error, works abnormally and has abnormal data, but the PLC body is still run.
Terminals	L+	External power supply DC24V +
	M	External power supply DC24V -
	C0	VI0 output ground
	VI0	Channel 1 AD voltage input
	C1	VI1 output ground
	VI1	Channel 2 AD voltage input
	C2	VI2 output ground
	VI2	Channel 3 AD voltage input
	C3	VI3 output ground
	VI3	Channel 4 AD voltage input
	C4	VI4 output ground
	VI4	Channel 5 AD voltage input
	C5	VI5 output ground
	VI5	Channel 6 AD voltage input
	C6	VI6 output ground
	VI6	Channel 7 AD voltage input
	C7	VI7 output ground
VI7	Channel 8 AD voltage input	

### 6-2-3. Wiring connector specification

When wiring the module, its connector shall meet the following requirements:

- (1) Stripping length 9mm
- (2) Flexible wire with tubular bare end 0.25-1.5mm<sup>2</sup>
- (3) Flexible wire with tubular pre-insulated end 0.25-0.5mm<sup>2</sup>

### 6-3. I/O address

XL series analog module does not occupy the I/O unit, and the converted value is directly sent to the PLC register. The PLC register definition number corresponding to the channel is as follows:

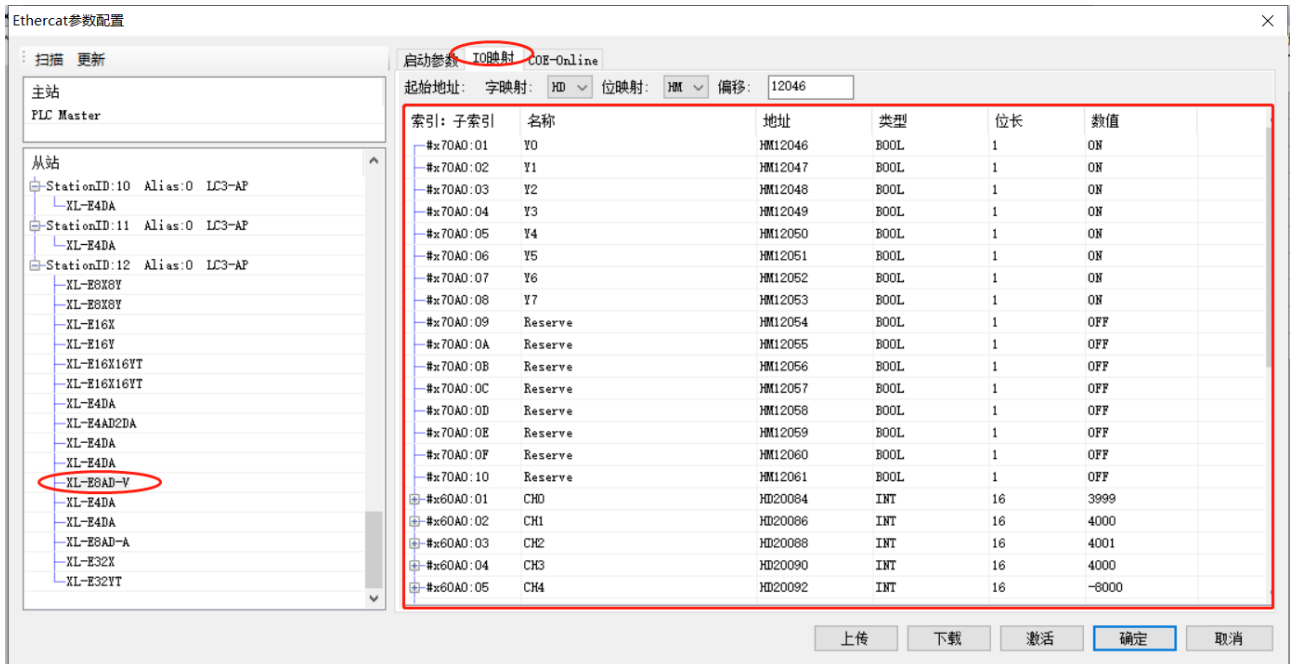

#x60A0:05	CH4	HD20092	INT	16	3998
#x60A0:06	CH5	HD20094	INT	16	3998
#x60A0:07	CH6	HD20096	INT	16	4000
#x60A0:08	CH7	HD20098	INT	16	3999

Note: the reserve channel is a reserved channel, which has no practical significance

#### IO mapping register definition: (take above figure as an example)

Channel	AD signal mapping address	Channel enable bit (turn on the enable bit to use this channel)	Channel mapping address
CH0	HD20084	Y0	HM12046
CH1	HD20086	Y1	HM12047
CH2	HD20088	Y2	HM12048
CH3	HD20090	Y3	HM12049
CH4	HD20092	Y4	HM12050
CH5	HD20094	Y5	HM12051
CH6	HD20096	Y6	HM12052
CH7	HD20098	Y7	HM12053

#### Note:

- (1) Disabling unused channels can improve the scanning speed of input/output.
- (2) When the input enable bit is turned off during operation, the corresponding input channel will not collect data. (data is displayed as 0)

## 6-4. Working mode

### 6-4-1. Panel configuration

Please use XDPpro software V3.7.0 and up to configure the module.

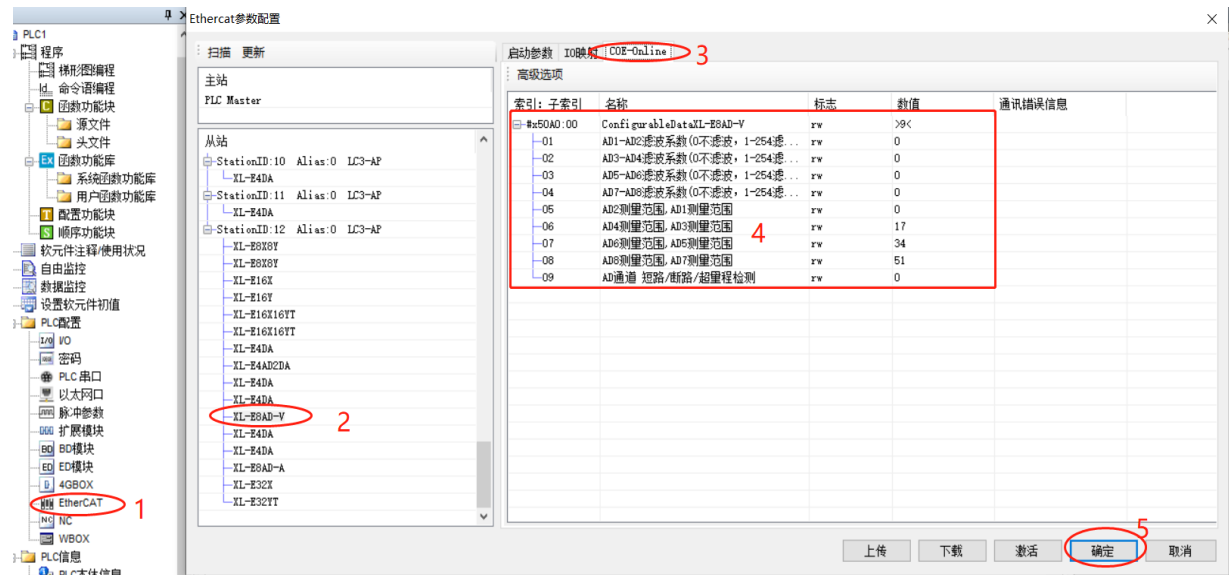

Step 1: click EtherCAT

Step 2: choose the module

Step 3: click COE-Online

Step 4: set the AD filter coefficient, AD channel voltage mode. Please check the bit definition of #x5000.

Step 5: after setting, click ok, then cut the power and power on again for the adapter to make the settings effective.

Note: The first-order low-pass filtering method uses this sampling value and the last filtering output value to weight to obtain the effective filtering value. The filter coefficient is set to 0 ~ 254 by the user. The smaller the value, the more stable the data is, but it may lead to data lag. Therefore, when set to 1, the filtering effect is the strongest and the data is the most stable. When set to 254, the filtering effect is the weakest. The default is 0 (no filtering).

### 6-4-2. #x5000 bit definition

The input channel of the expansion module is in voltage mode, with options of 0 ~ 5V, 0 ~ 10V, - 5 ~ 5V and -10 ~ 10V, which can be set through #x5000. As follows:

	Bit7	Bit6	Bit5	Bit4	Bit3	Bit2	Bit1	Bit0	Note
Byte0	AD channel 2, 1 filter coefficient								AD filter coefficient
Byte1	AD channel 4, 3 filter coefficient								
Byte2	AD channel 6, 5 filter coefficient								
Byte3	AD channel 8, 7 filter coefficient								
Byte4	Bit7	Bit6	Bit5	Bit4	Bit3	Bit2	Bit1	Bit0	to specify the input range of the AD module, 05 lower 4 bits are the setting bits of AD channel 1, and the upper 4 bits are the setting bits of AD channel 2.
	AD2				AD1				
	0000: voltage 0~10V				0000: voltage 0~10V				
	0001: voltage 0~5V				0001: voltage 0~5V				
	0010: voltage -10~10V				0010: voltage -10~10V				
0011: voltage -5~5V				0011: voltage -5~5V					
Byte5	Bit7	Bit6	Bit5	Bit4	Bit3	Bit2	Bit1	Bit0	06 lower 4 bits are the
	AD4				AD3				



	0000: voltage 0~10V 0001: voltage 0~5V 0010: voltage -10~10V 0011: voltage -5~5V				0000: voltage 0~10V 0001: voltage 0~5V 0010: voltage -10~10V 0011: voltage -5~5V				setting bits of AD channel 3, and the upper 4 bits are the setting bits of AD channel 4.
Byte6	Bit7	Bit6	Bit5	Bit4	Bit3	Bit2	Bit1	Bit0	
	AD6				AD5				07 lower 4 bits are the setting bits of AD channel 5, and the upper 4 bits are the setting bits of AD channel 6
	0000: voltage 0~10V 0001: voltage 0~5V 0010: voltage -10~10V 0011: voltage -5~5V				0000: voltage 0~10V 0001: voltage 0~5V 0010: voltage -10~10V 0011: voltage -5~5V				
Byte7	Bit7	Bit6	Bit5	Bit4	Bit3	Bit2	Bit1	Bit0	08 lower 4 bits are the setting bits of AD channel 7 and the upper 4 bits are the setting bits of AD channel 8.
	AD8				AD7				
	0000: voltage 0~10V 0001: voltage 0~5V 0010: voltage -10~10V 0011: voltage -5~5V				0000: voltage 0~10V 0001: voltage 0~5V 0010: voltage -10~10V 0011: voltage -5~5V				
Byte8	AD channel short circuit / open circuit / overtravel detection								

## 6-5. External wiring

During external connection, in order to avoid interference, please use shielded wire and ground the shielding layer at a single point.

### 6-5-1. Voltage single end input

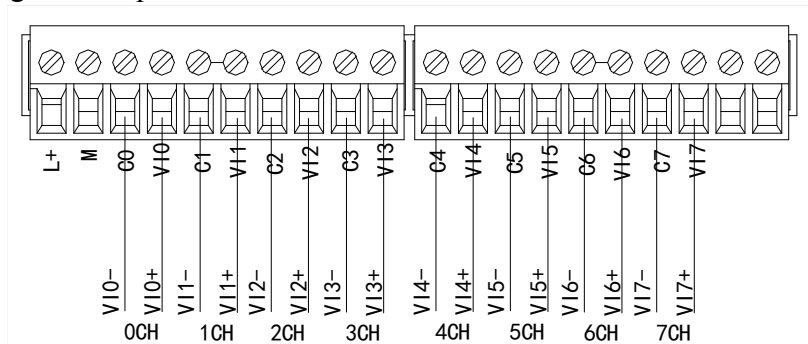

## 6-6. Analog digital conversion diagram

The relationship between input analog quantity and converted digital quantity is shown in the table below:

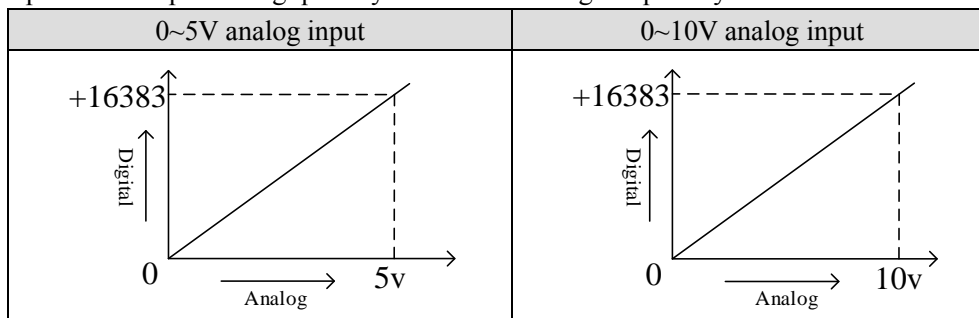

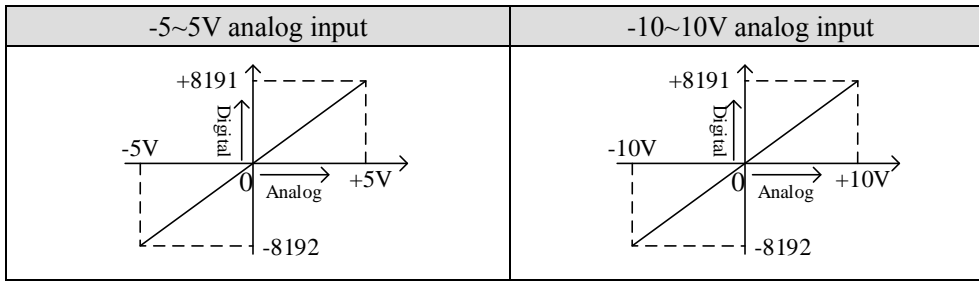

## 6-7. Dimension

(Unit: mm)

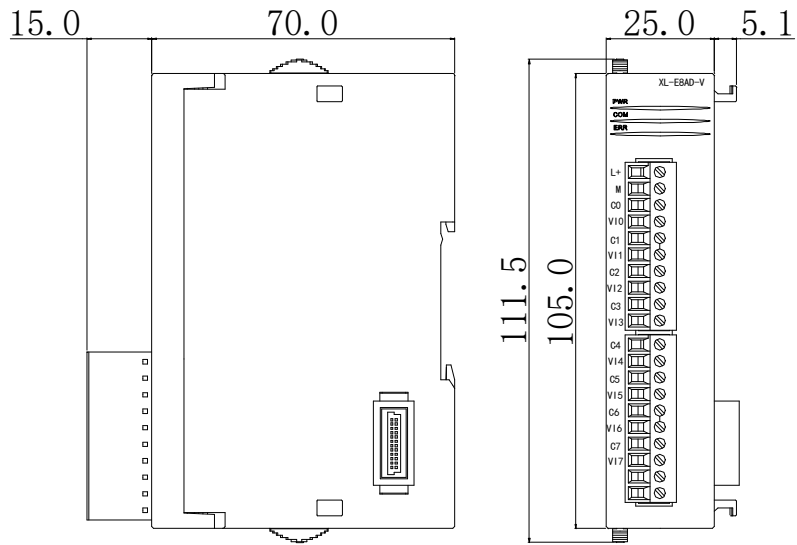

## 7. Analog output module XL-E4DA

### 7-1. Features and specification

XL-E4DA analog output module converts four digital quantities into analog quantities, transmits them to PLC main unit, and carries out real-time data interaction with PLC main unit.

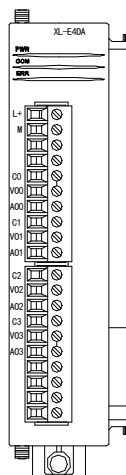

#### 7-1-1. Features

- 4-channel analog output: voltage output and current output are optional.
- 12-bit high-precision analog output.
- As an L series expansion module, LC3-AP adapter can connect up to 16 modules.
- Output 10 bytes and input 10 bytes, a total of 20 bytes. When using, pay attention to the maximum PDO byte limit of the master station.

#### 7-1-2. Specification

Item	Voltage output	Current output
Analog output range	0~5V, 0~10V, -5~5V, -10~10V (external load resistor 2K $\Omega$ ~1M $\Omega$ )	0~20mA, 4~20mA (external load resistor less than 500 $\Omega$ )
Digital input range	12-bit binary value (0~4095 or -2048~2047)	
Resolution	1/4095 (12-Bit)	
Comprehensive accuracy	1%	
Conversion speed	2ms/channel	2ms/channel
Module power supply	DC24V $\pm$ 10%, 150mA	
Installation method	It is directly installed on the guide rail of DIN46277 (width 35mm)	

## 7-2. Terminals

### 7-2-1. Terminal arrangement

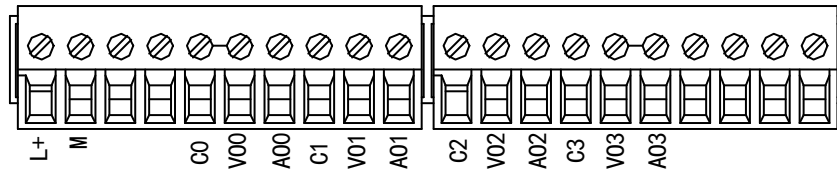

### 7-2-2. Terminal signals

Name		Function
Indicator	PWR	This indicator is on when the module has power supply
	COM	This indicator is on when the module communication port communicates normally
	ERR	When there is an error in the module, the indicator is always on or flashing (red) When ERR light is always on, it indicates that the module has serious application errors and cannot be used. The use mode must be adjusted, and the PLC body is switched to stop state. When ERR light flashes, it indicates that the module has application error, works abnormally and has abnormal data, but the PLC body is still run.
Terminals	L+	External power supply DC24V +
	M	External power supply DC24V -
	C0	VO0, AO0 output ground
	VO0	Channel 1 DA voltage output terminal
	AO0	Channel 1 DA current output terminal
	C1	VO1, AO1 output ground
	VO1	Channel 2 DA voltage output terminal
	AO1	Channel 2 DA current output terminal
	C2	VO2, AO2 output ground
	VO2	Channel 3 DA voltage output terminal
	AO2	Channel 3 DA current output terminal
	C3	VO3, AO3 output ground
	VO3	Channel 4 DA voltage output terminal
AO3	Channel 4 DA current output terminal	

### 7-2-3. Wiring connector specification

When wiring the module, its connector shall meet the following requirements:

- (1) Stripping length 9mm
- (2) Flexible wire with tubular bare end 0.25-1.5mm<sup>2</sup>
- (3) Flexible wire with tubular pre-insulated end 0.25-0.5mm<sup>2</sup>

### 7-3. I/O address

XL series analog module does not occupy the I/O unit, and the converted value is directly sent to the PLC register. The PLC register definition number corresponding to the channel is as follows:

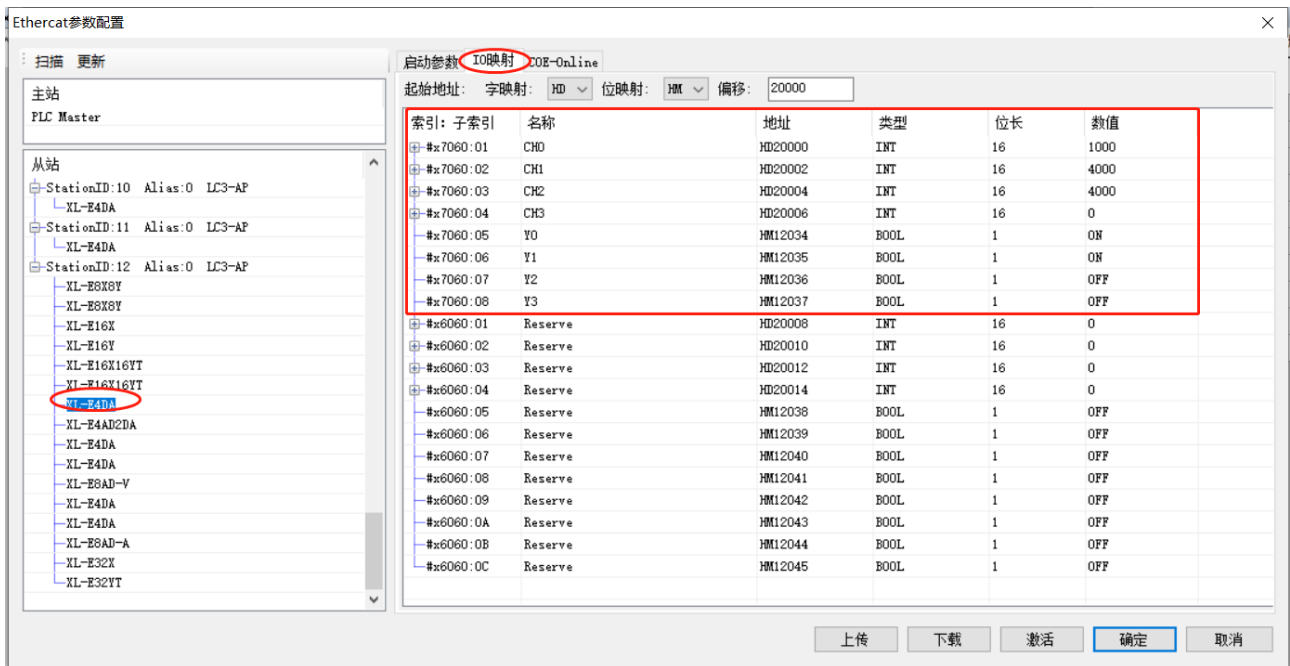

**IO mapping register definition: (take above figure as an example)**

Channel	DA signal	Channel enable bit (turn on the enable bit to use this channel)	Channel mapping address
0CH	HD20000	Y0	HM12034
1CH	HD20002	Y1	HM12035
2CH	HD20004	Y2	HM12036
3CH	HD20006	Y3	HM12037

**Note:**

- (1) Disabling unused channels can improve the scanning speed of input/output.
- (2) When the enable bit of the output is turned off during operation, the corresponding output channel keeps the original data unchanged.

## 7-4. Working mode

### 7-4-1. Panel configuration

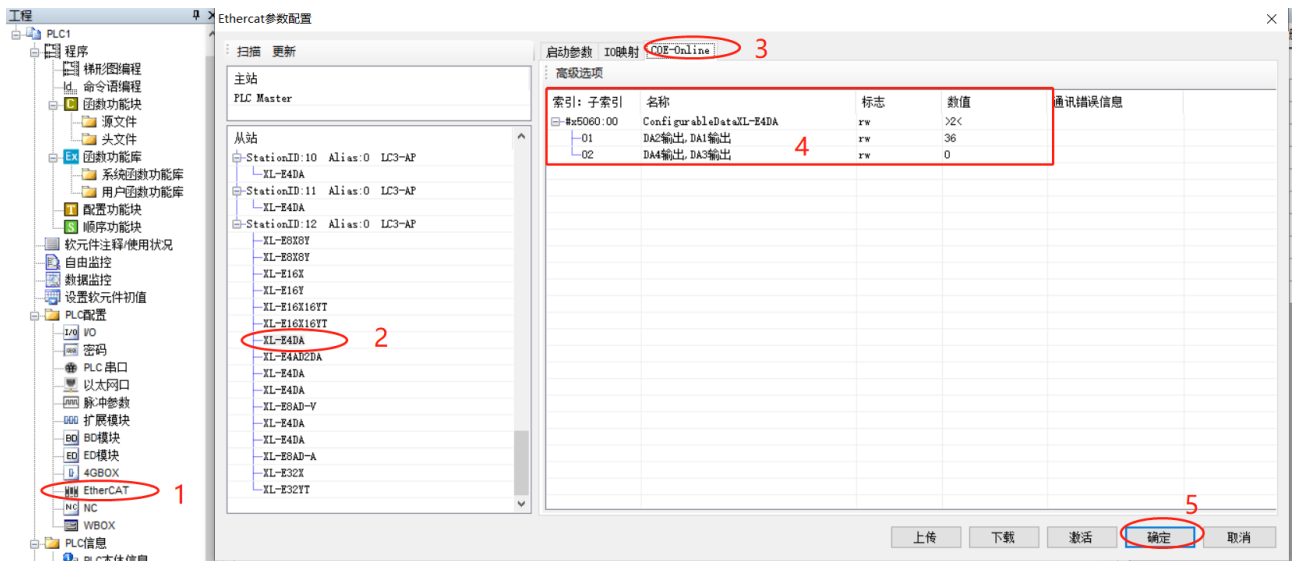

Step 1: click EtherCAT

Step 2: choose the module

Step 3: click COE-Online

Step 4: set the DA channel voltage current output mode. Please check the bit definition of #x5000.

Step 5: after setting, click ok, then cut the power and power on again for the adapter to make the settings effective.

### 7-4-2. #x5000 bit definition

	Bit7	Bit6	Bit5	Bit4	Bit3	Bit2	Bit1	Bit0	Note
Byte0	DA2				DA1				
	-	voltage	current		-	voltage	current		
		000: 0~10V	010: 0~20mA		000: 0~10V	010: 0~20mA			
		001: 0~5V	011: 4~20mA		001: 0~5V	011: 4~20mA			
		100: -10~10V			100: -10~10V				
		101: -5~5V				101: -5~5V			
Byte1	DA4				DA3				
	-	voltage	current		-	voltage	current		
		000: 0~10V	010: 0~20mA		000: 0~10V	010: 0~20mA			
		001: 0~5V	011: 4~20mA		001: 0~5V	011: 4~20mA			
		100: -10~10V			100: -10~10V				
		101: -5~5V				101: -5~5V			

## 7-5. External wiring

During external connection, in order to avoid interference, please use shielded wire and ground the shielding layer at a single point.

### 7-5-1. Voltage single end output

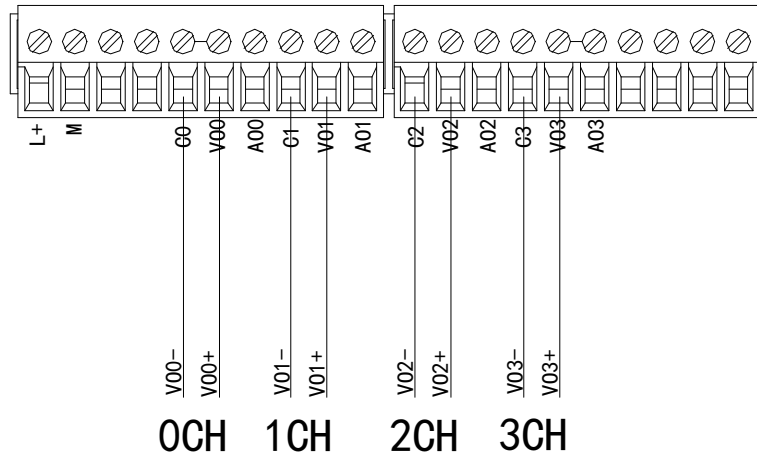

### 7-5-2. Current single end output

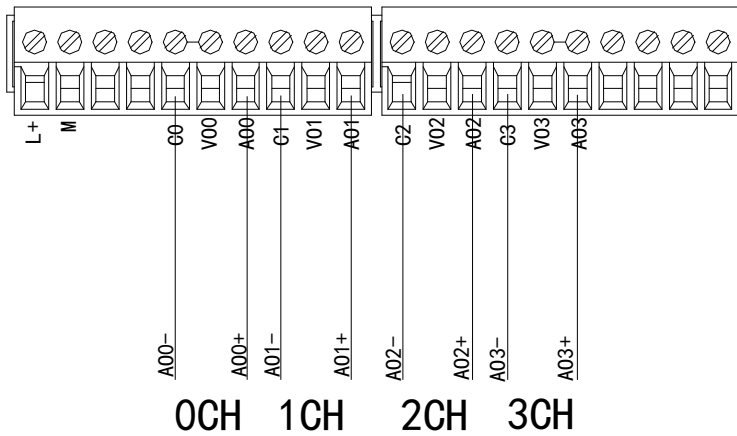

XL-E4DA current output wiring diagram:

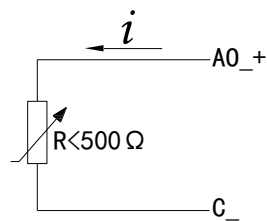

**Note: current output no need to connect DC24V power supply.**

## 7-6. Analog digital conversion diagram

The relationship between the output digital quantity and its corresponding analog quantity data is shown in the table below:

0~5V analog output	0~10V analog output	-5~5V analog output
-10~10V analog output	0~20mA analog output	4~20mA analog output

When the input data exceeds K4095, the output analog data of D/A conversion remains unchanged at 5V, 10V or 20mA.

## 7-7. Dimension

(Unit: mm)

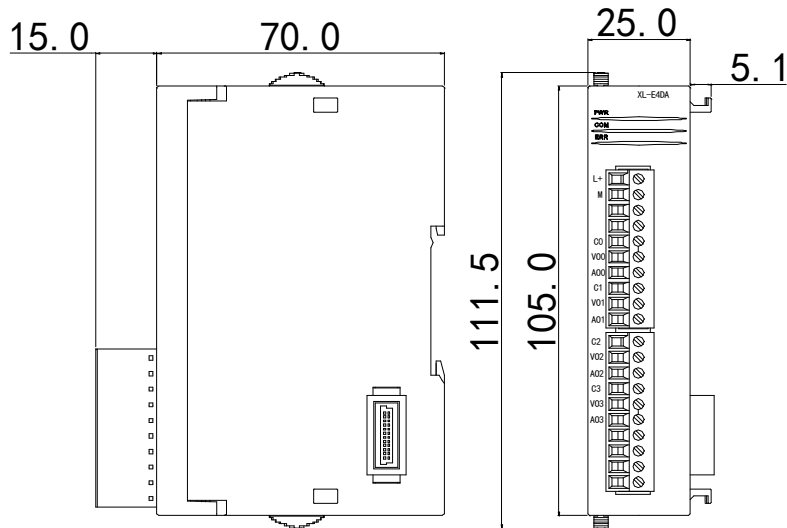



## 8. Application of LC3-AP and Xinje XG2 PLC

### 8-1. System configuration

Name	Model	Quantity	Note
Motion control software	CODESYS	1	Software: V3.7.1
Xinje EtherCAT master station	XG2 series PLC	1	Firmware: V3.6.2
Xinje remote IO slave station	L series	Some	
Xinje remote expansion module	XL series	Some	
Network cable	JC-CA-3	Some	To connect PC and servo driver

### 8-2. System topology

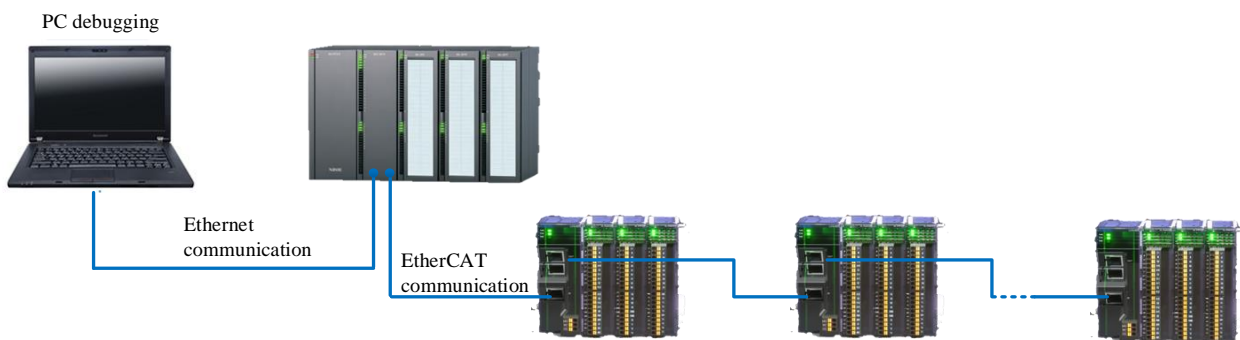

XG2 series PLC has upper and lower network ports. The upper network port is Ethernet/IP, which is used to connect XDPpro upper computer. The lower network port is EtherCAT connection port, which is used to connect L series remote IO to realize EtherCAT communication. The two communication network ports of Xinje L series remote IO shall follow the principle of "bottom in and top out".

XG2 master station can connect up to 32 L series remote IO adapters, and LC3-AP adapter can connect up to 16 modules. The maximum PDO of XG2 is 8192 bytes, which should be paid attention to during model selection.

### 8-3. Debugging steps

#### 8-3-1. Add XML File

Before opening the software, we need to copy the description XML file of LC3-AP adapter device to the installation directory of XDPpro. The default path is C:\XDPPro\ethercat\vendorxml.

#### 8-3-2. Create communication between XDPPro and XG2

(1) Modify the PC Ethernet IP to 192.168.6.xxx.

(2) Open XDPPro software.

① click communication configuration, choose Xnet protocol, designated address, default IP is 192.168.6.6. click ok.

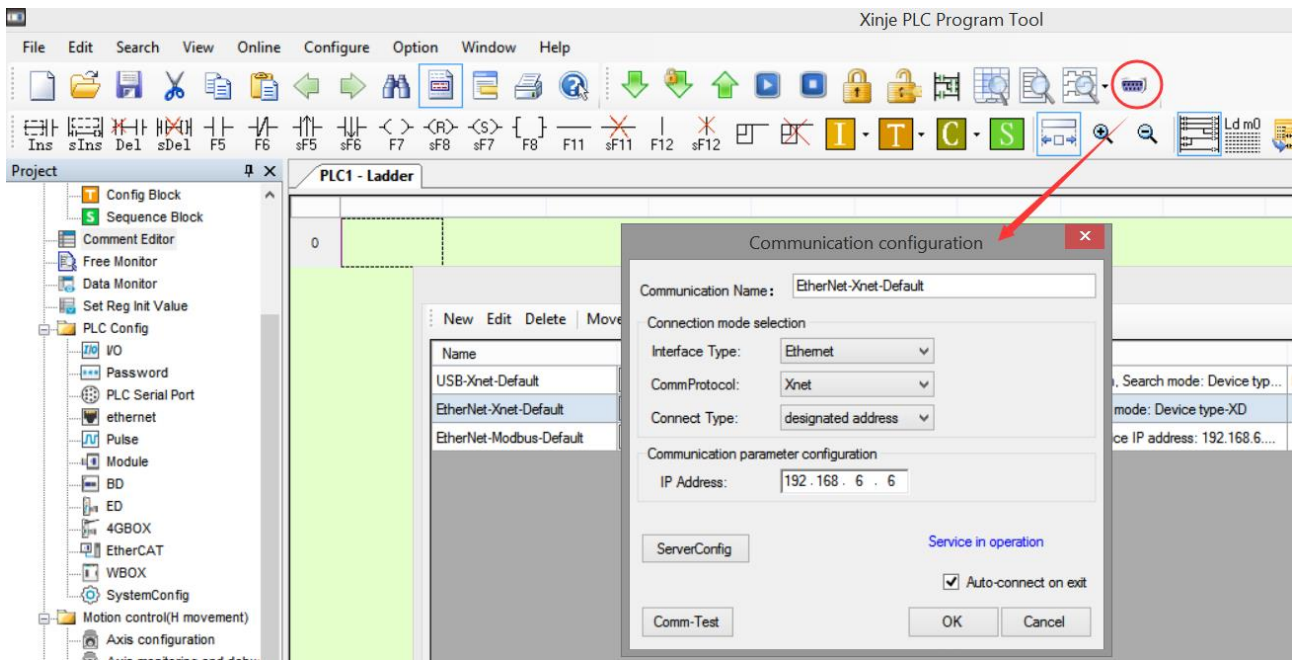

② If it shows the message “the model and serial number are inconsistent with the PLC”, please click ok to automatically select the appropriate model.

③ Check whether the PLC model is XG2 at the bottom of the interface and whether there is “RUN” in the lower right corner. If there is no “RUN”, double-click in the lower right corner to check.

### 8-3-3. Scan the slave station device

① Click EtherCAT, it will show Ethercat configuration interface

② click scan

③ Check whether the number of slave stations scanned and the modules are correct. If there is an error, you can try to scan multiple times, check whether there is an error in the hardware connection, and try to power on again.

④ Click OK after confirmation.

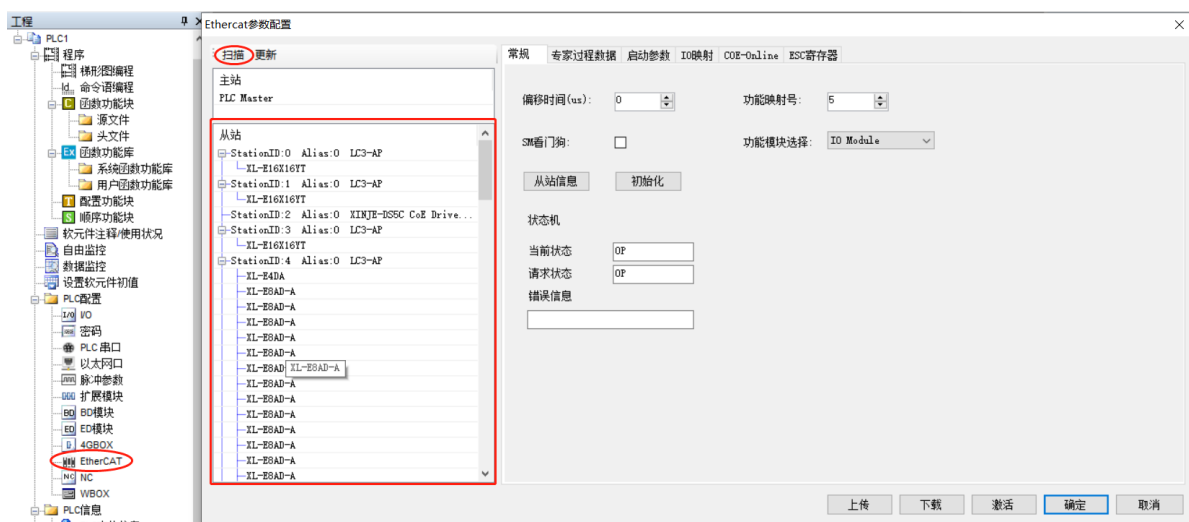

### 8-3-4. EtherCAT parameter configuration

① Confirm that the state machines of all slaves are in the OP state. If not, you can click to activate and switch the state again. If it is not activated, check whether the module carried by the slave station corresponds to the actual module connected one by one. Or check whether the status light of the slave station reports an error.

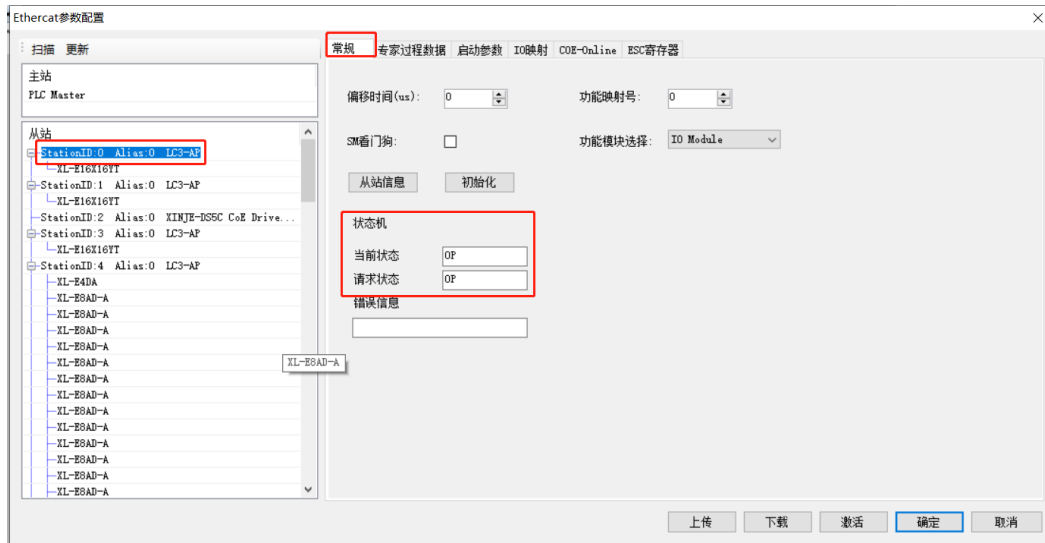

② Select the expansion module and click IO mapping to view the bit address corresponding to 16X16Y. The address starts from HM10000 by default, and you only need to control the HM address mapped by XY to control the input and output of the module.

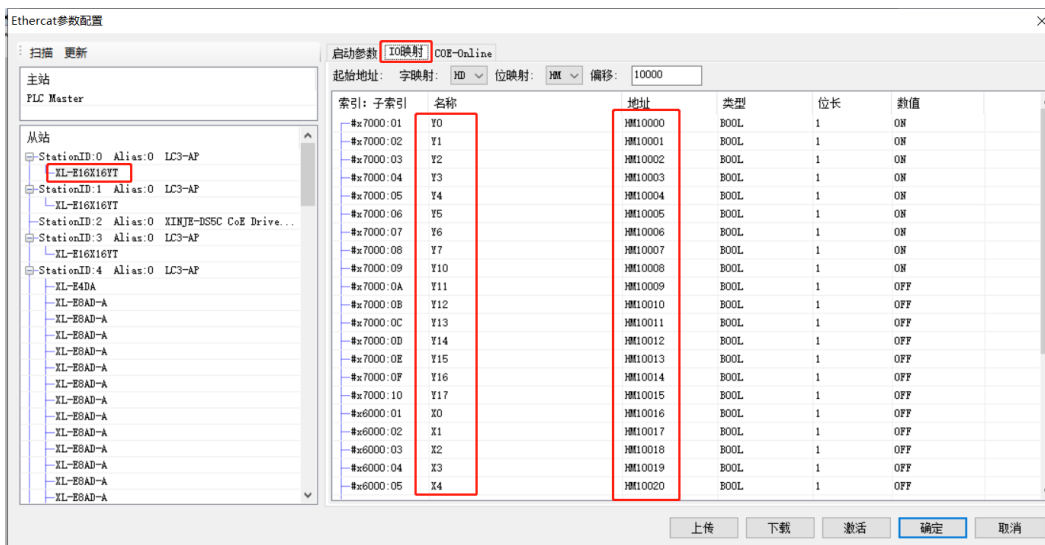

③ Click COE-Online to modify the filter time and positive and negative logic. After the modification is completed, the slave station needs to be powered on again to take effect. For details, please refer to chapter 2-5.

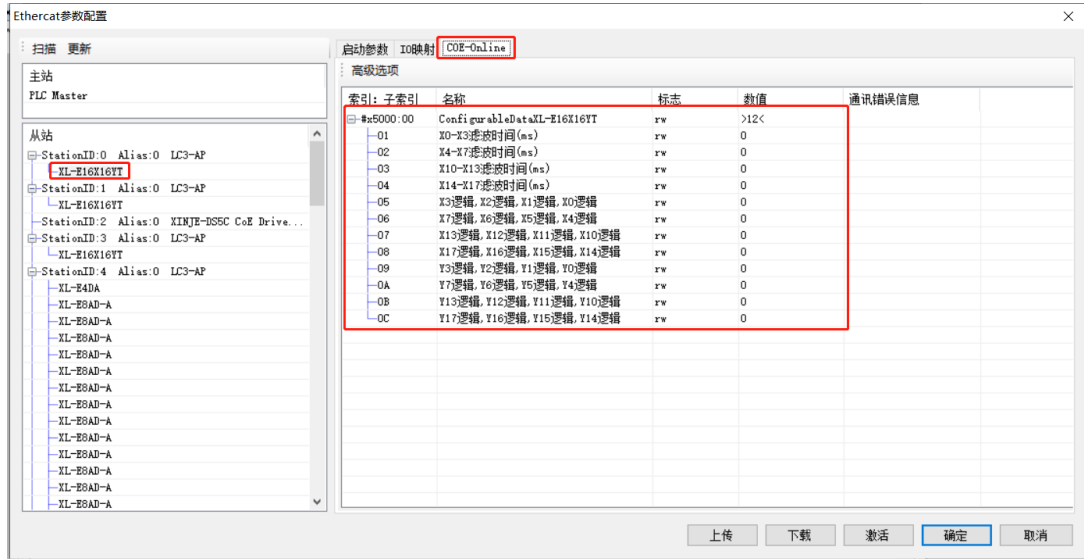

### 8-3-5. Program

According to the above figure, Y0, Y1 correspond to the mapping addresses HM10000, HM10001. X0, X1 correspond to the mapped addresses HM10016, HM10017.

Program directly with the mapped HM address. When M0 and M1 are set to ON, HM10000 and HM10001 are set to NO, and Y0 and Y1 have output signals.

When X0, X1 have signal input, HM10016, HM10017 turn ON, and M2, M3 turn ON.

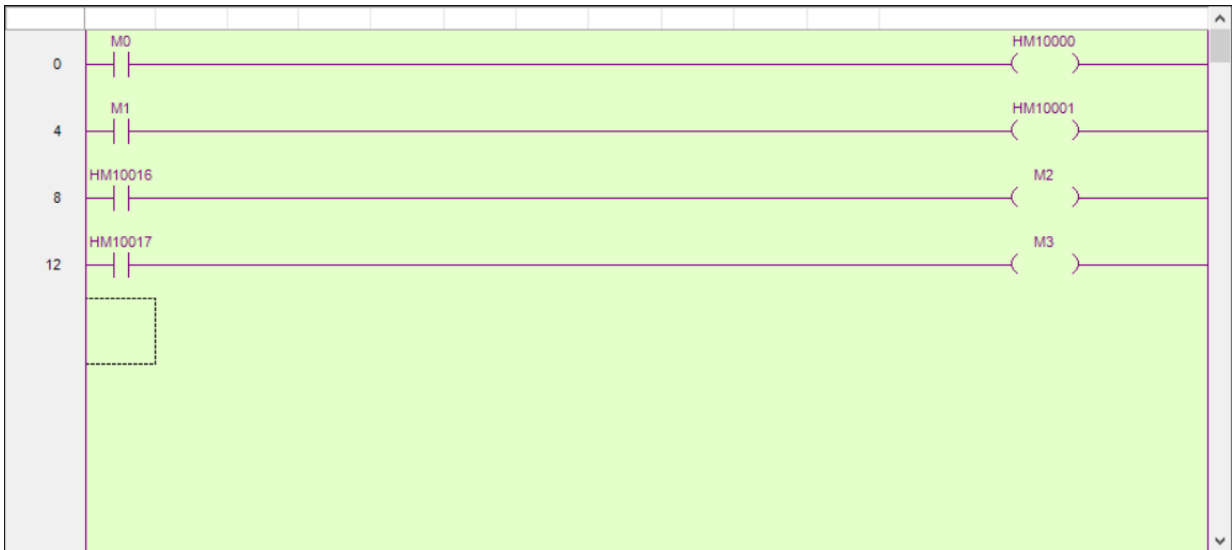

## 9. LC3-AP and TwinCAT application

This example will illustrate how the Beckhoff TWINCAT control software is used as the EtherCAT master and the XINJE remote IO is used as the slave to realize EtherCAT control.

### 9-1. System configuration

Name	Model	Quantity	Note
Motion control software	TWINCAT XAE (VS 2013)	1	Application version used in this example: TC31-FULL-Setup.3.14022.27
Xinje remote IO slave station	L series	Some	
Xinje remote expansion module	XL series	Some	
Network cable	JC-CA-3	Some	For connection between computer and servo

### 9-2. System topology

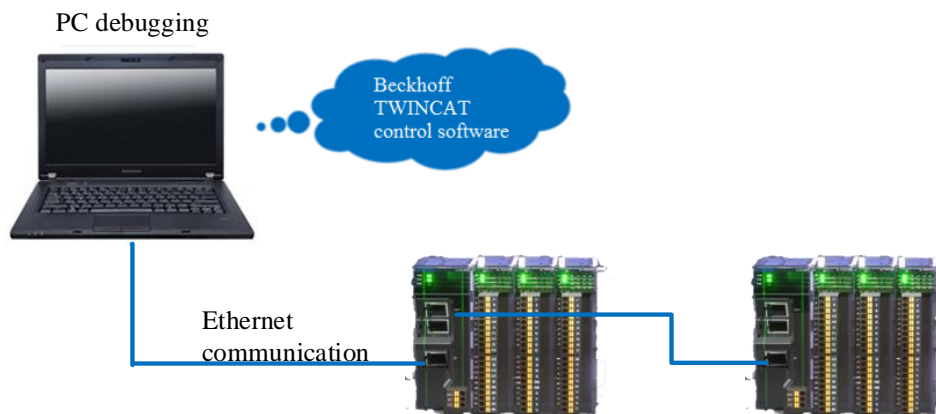

The two communication network ports of Xinje remote IO adapter follow the principle of "bottom in and top out", that is, the master station must be connected to the network port below the CN1 port of the first slave station, and then the top network port of the first slave station must be connected to the bottom network port of the second slave station, and so on.

### 9-3. Debugging steps

#### 9-3-1. Add XLM file

Before opening the software, we need to copy the XML file of the remote IO to the TwinCAT installation directory, the default path is C:\TwinCAT\3.1\Config\Io\EtherCAT.

#### 9-3-2. New project

Open the TwinCAT XAE (VS 2013) software and create a new project:

- (1) execute FILE—NEW—Project
- (2) select TwinCAT Project, after entering the project name and the project save path, click OK, and then the property explorer will appear in the project bar.

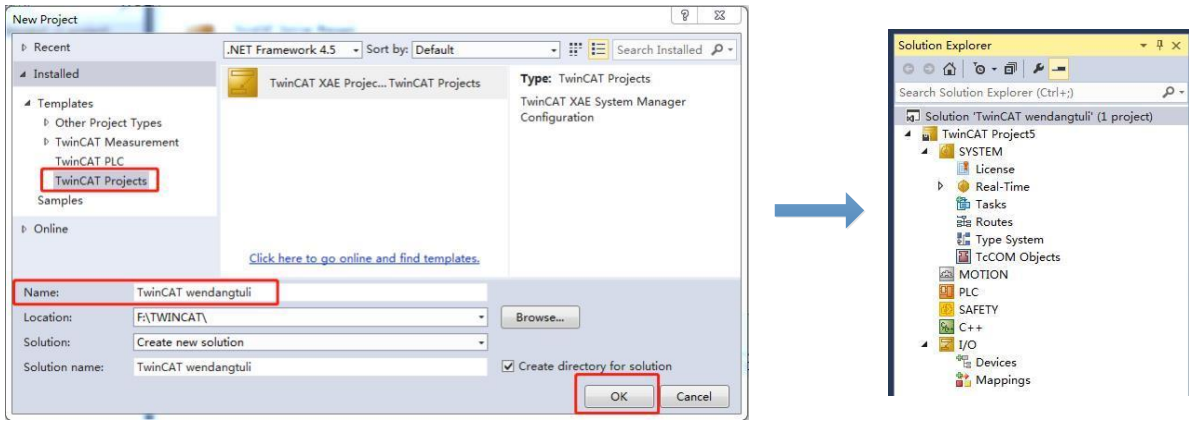

### 9-3-3. Hardware scan

at this time, if the controller is not in config mode, click , switch to config mode, then right click Device/Scan.

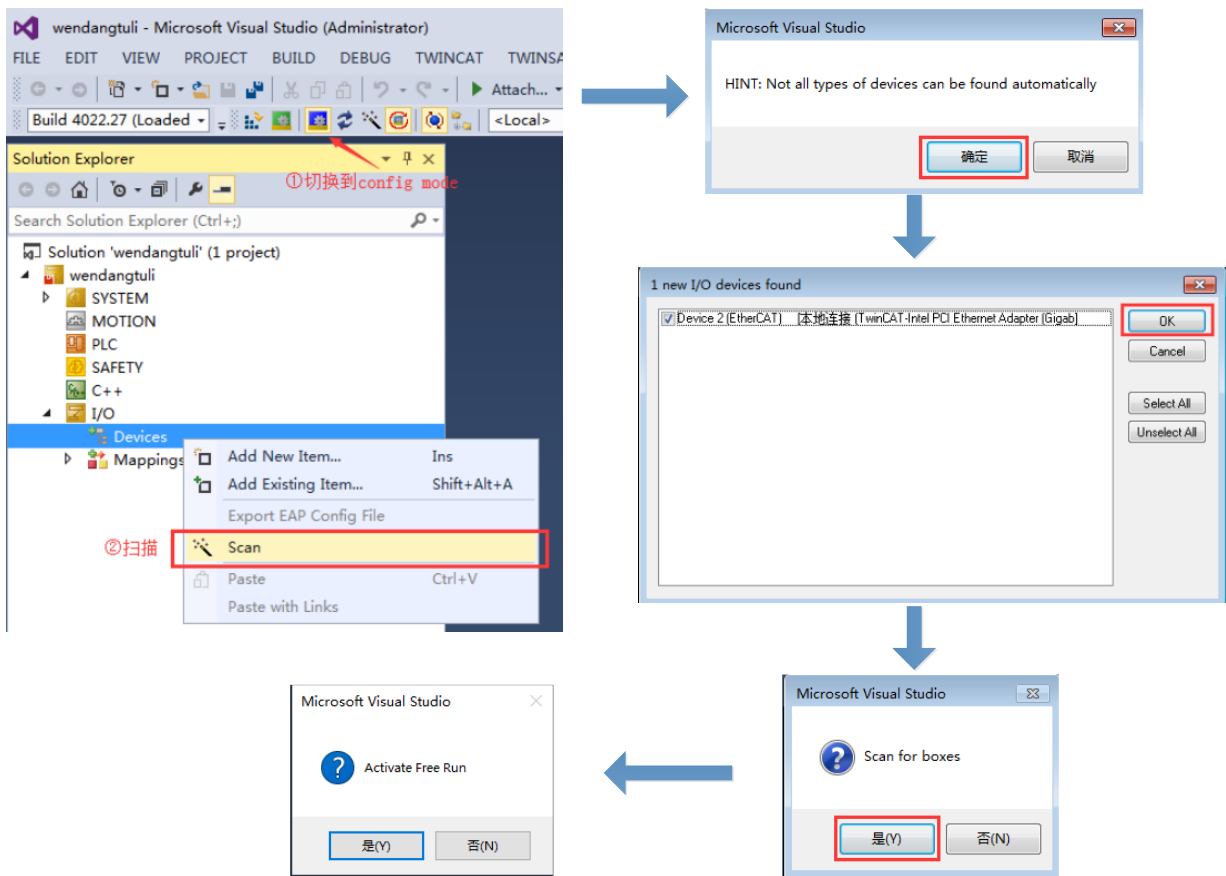

After scanning, it will show below window:

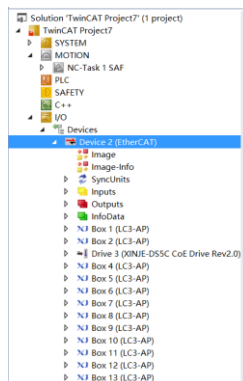

### 9-3-4. Slave station parameters

(1) Click BOX, select Online. Confirm that the state machines of all slaves are in the OP state.

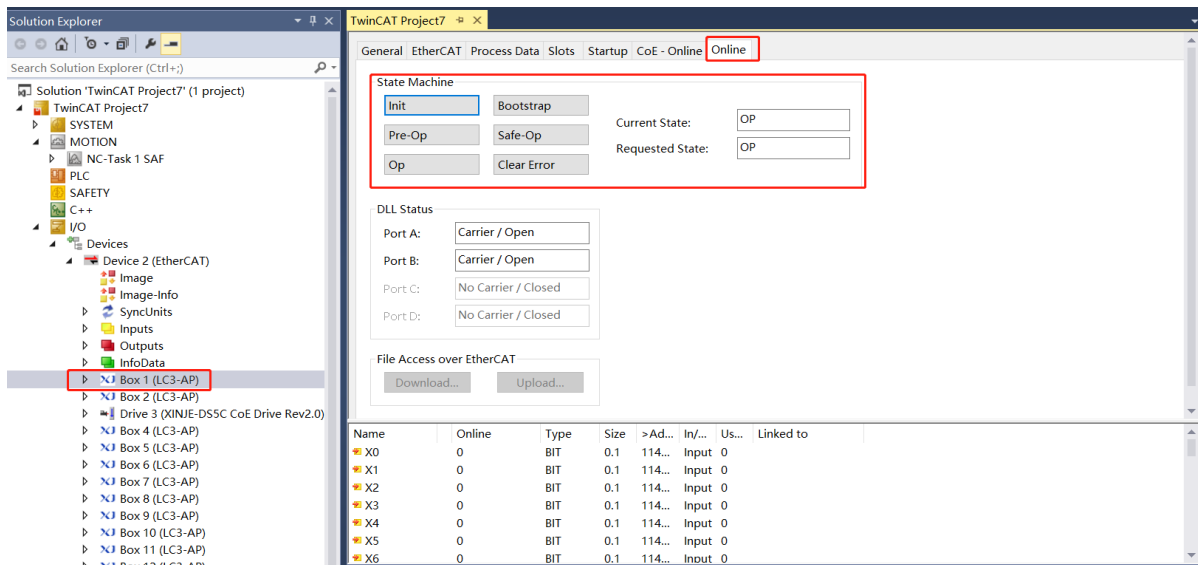

(2) Click BOX, select CoE-Online. Modify the filter time and positive and negative logic. After the modification is completed, the slave station needs to be powered on again to take effect. For details, please refer to chapter 3-5.

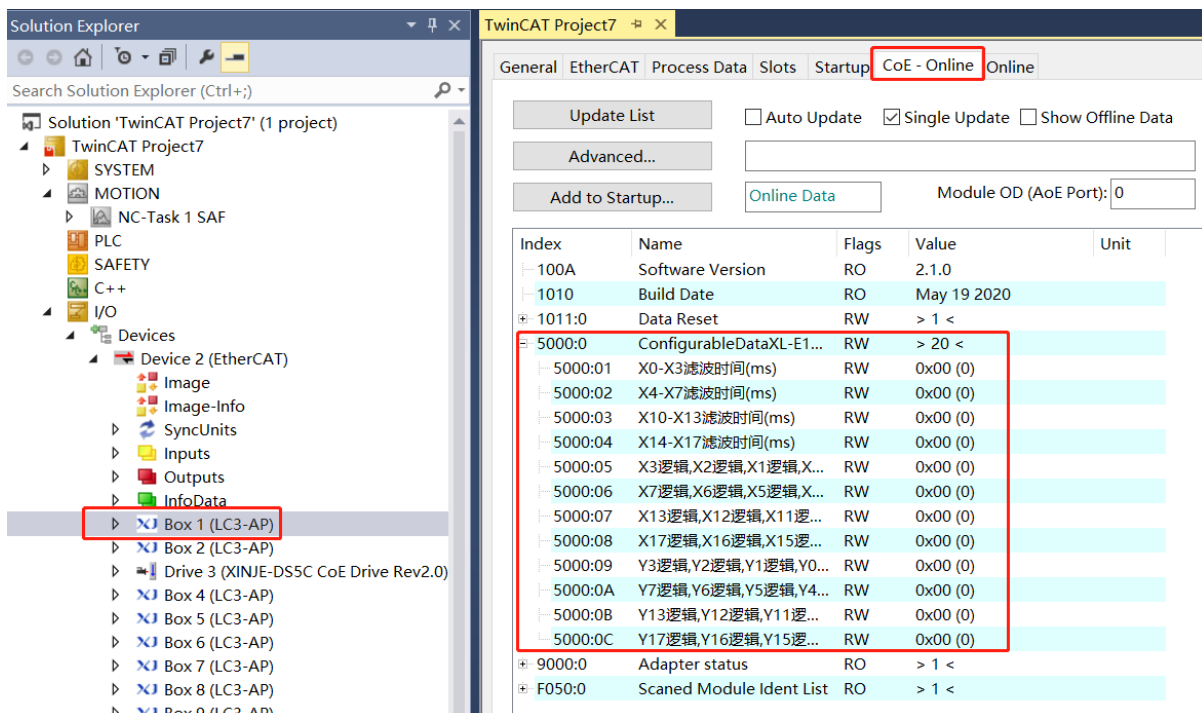

### 9-3-5. Create variables and link

(1) Right click PLC, select Add New Item.

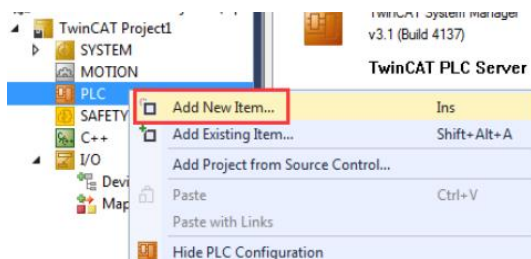

(2) Select Standard PLC Project. And change the name to English, such as "test" in the picture below.

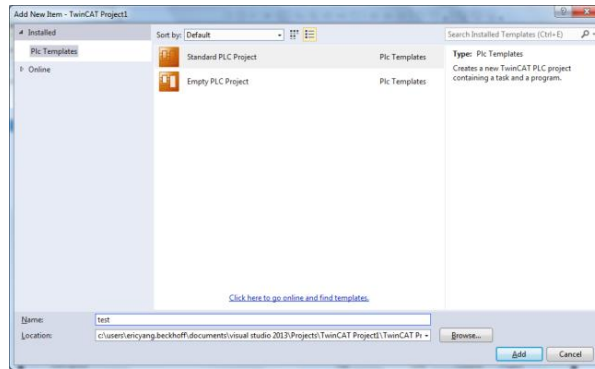

(3) Double click Main under POU's, and make a simple program:

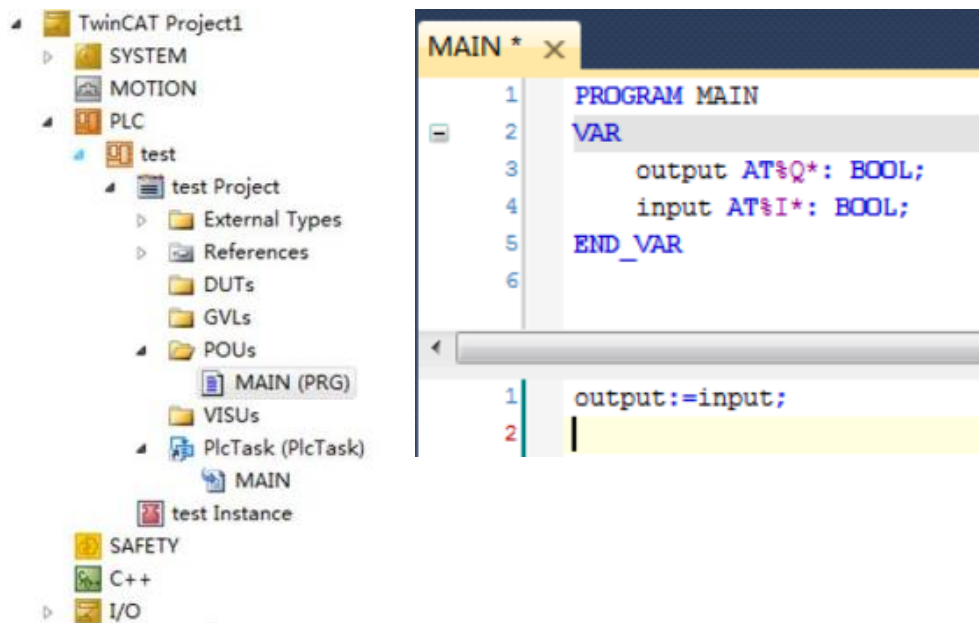

(4) After programming, right click test Project, select Build

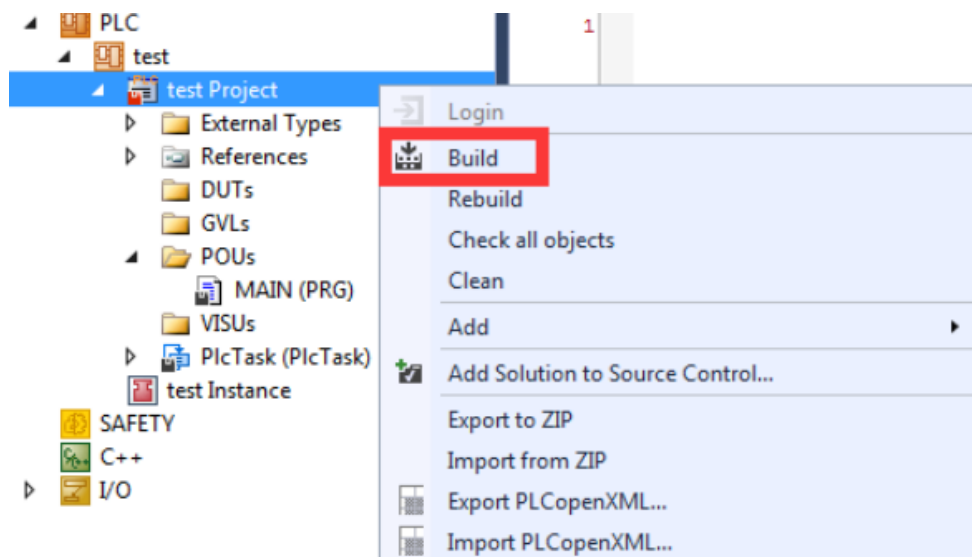

(5) The system will automatically compile this code. If there is no error, it will prompt the successful generation in the message bar, and the input and output variables will be generated in the test Instance for linking.



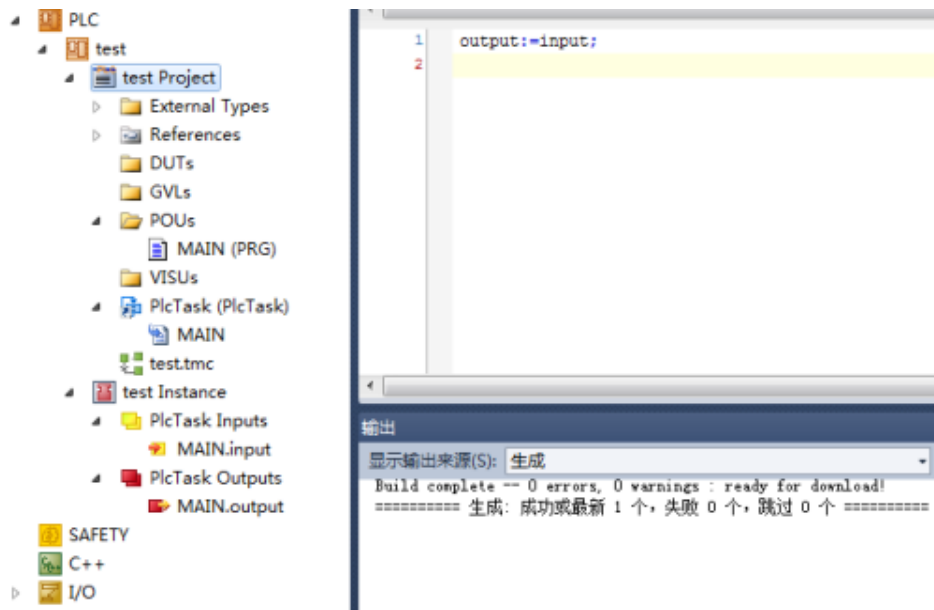

(6) Click the input and output variables in the module to start variable linking.

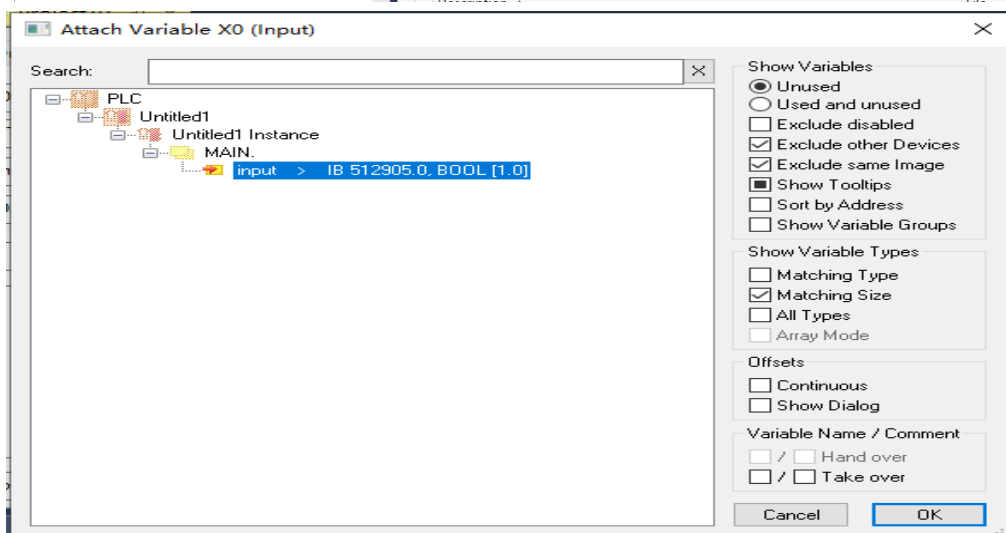
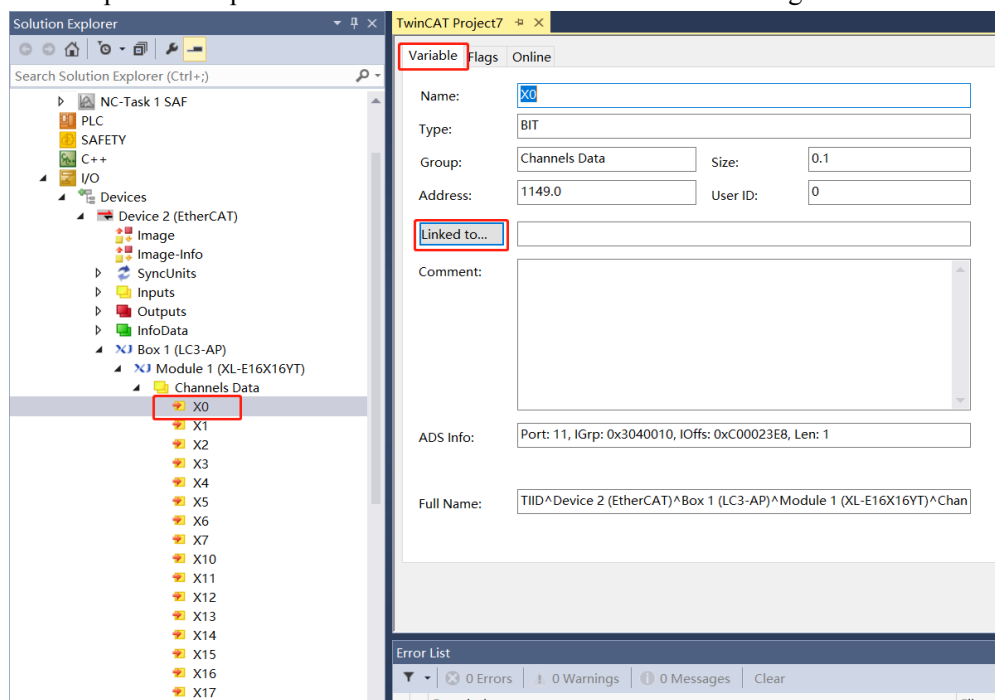

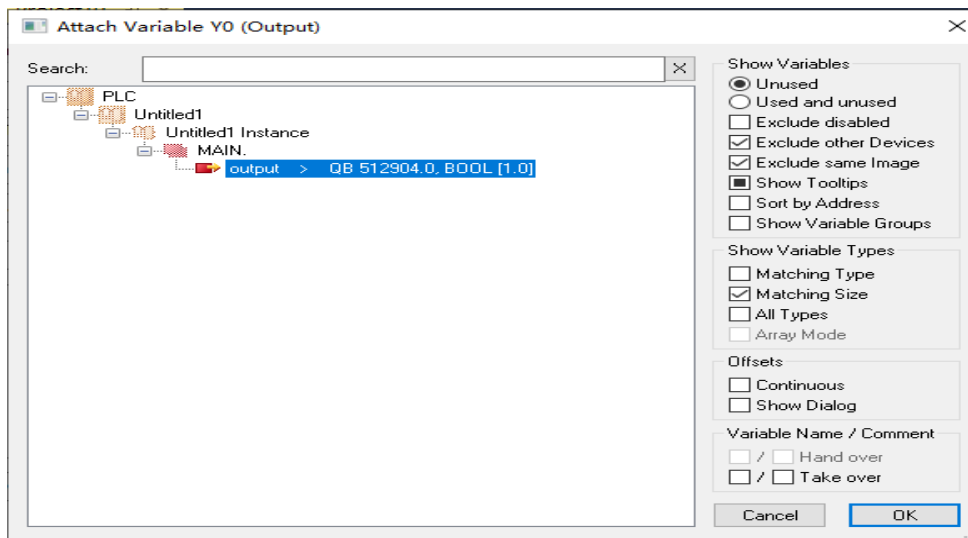
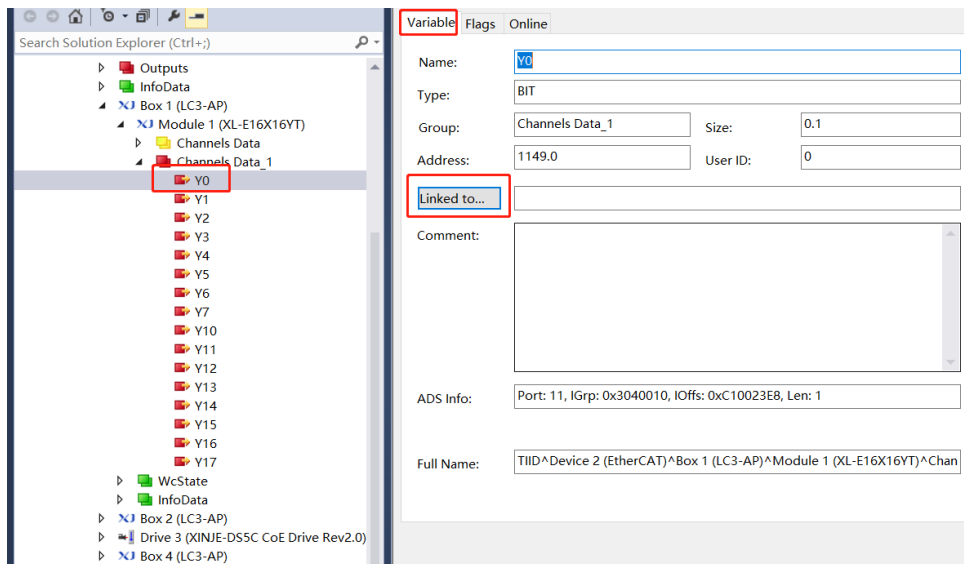

(7) After linking variable, select TwinCAT, click Activate Configuration

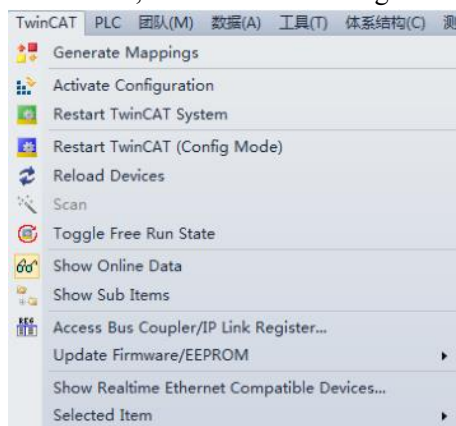

(8) Click ok in below window:

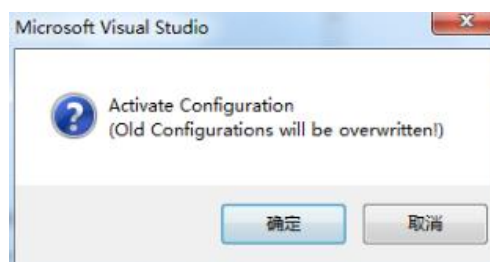

- (9) If the following window pops up, it means that some licenses in your project have not been activated, but it does not matter, click Yes to reactivate the missing licenses.

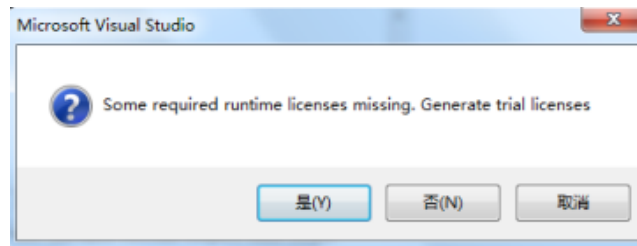

- (10) Enter 5 security codes then click ok

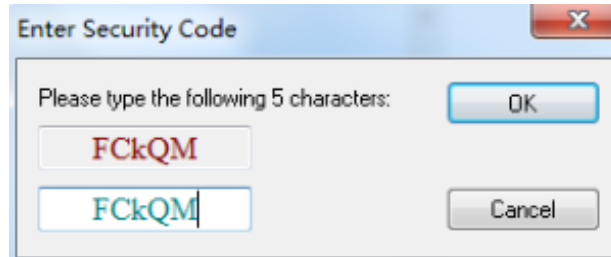

- (11) Click ok to switch to RUN mode.

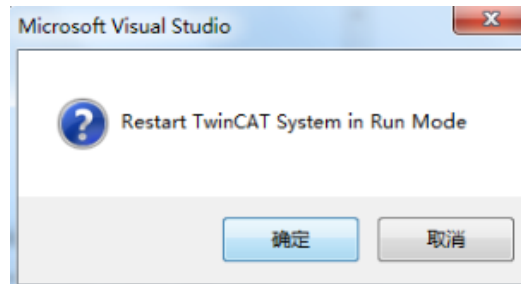

- (12) Click Login



Click Yes in below window:



- (13) Click Start to run the program

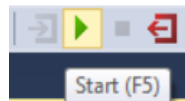

The program runs normally, when the module X0 has a signal input, the variables output and input both become TRUE.



## 10. LC3-AP and CODESYS application

This example will illustrate how the CODESYS motion control software is used as the EtherCAT master station (Xinje XS3 series PLC is only used as a hardware platform), and how the Xinje remote IO is used as the slave station to realize EtherCAT remote control.

### 10-1. System configuration

Name	Model	Quantity	Note
Motion control software	CODESYS	1	Software version: V3.5 SP13 Patch 1
Hardware control platform	XS3 series PLC	1	
Xinje remote IO slave station	L series	Some	
Xinje remote expansion module	XL series	Some	
Network cable	JC-CA-3	Some	For connection between computer and servo

### 10-2. System topology

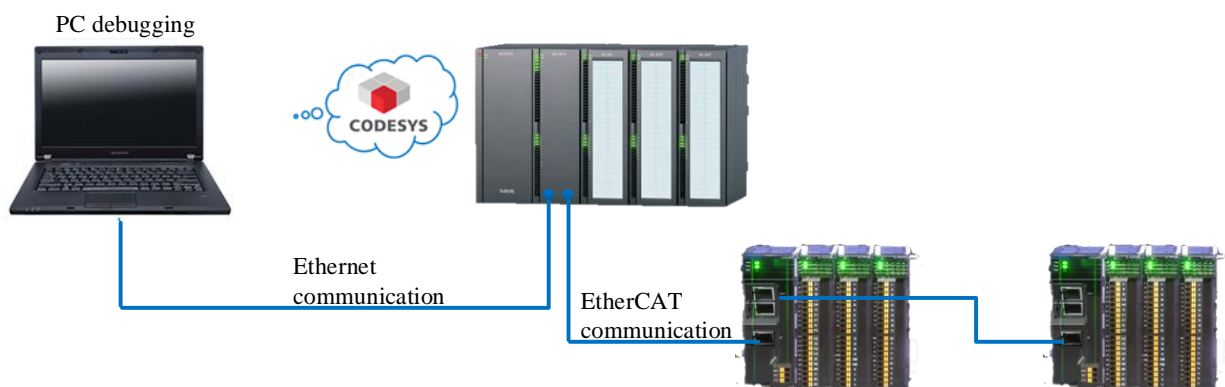

### 10-3. Debugging steps

#### 10-3-1. New project

Open Codesys software, click New Project, enter the project name and storage path, click ok.

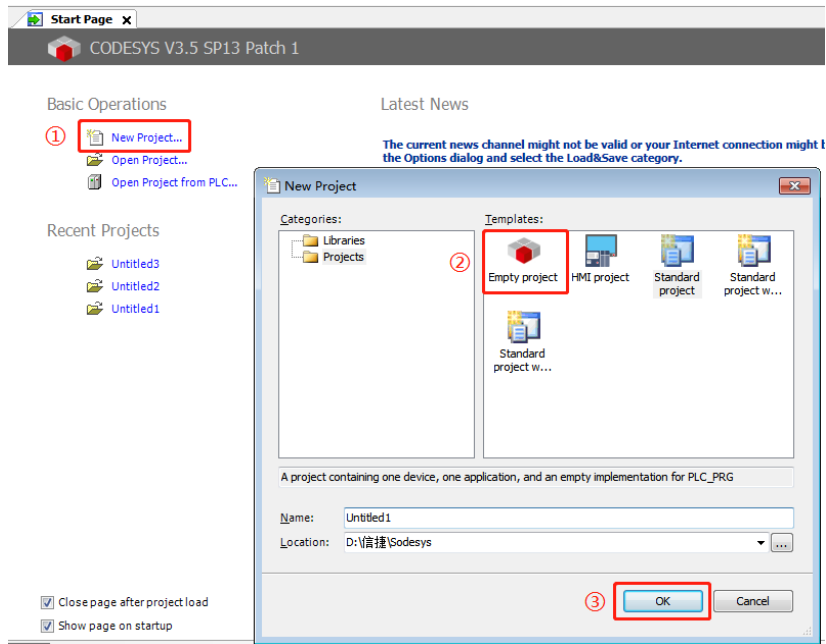

### 10-3-2. Add XML file

Open the tool device library and add the XML files of the master device and the slave device respectively. First, add the XML file of the master device here. Click Tools--Device Repository in turn, click Install in the pop-up dialog box, select the path where the XML file is located to find the XML file, select it and click Open.

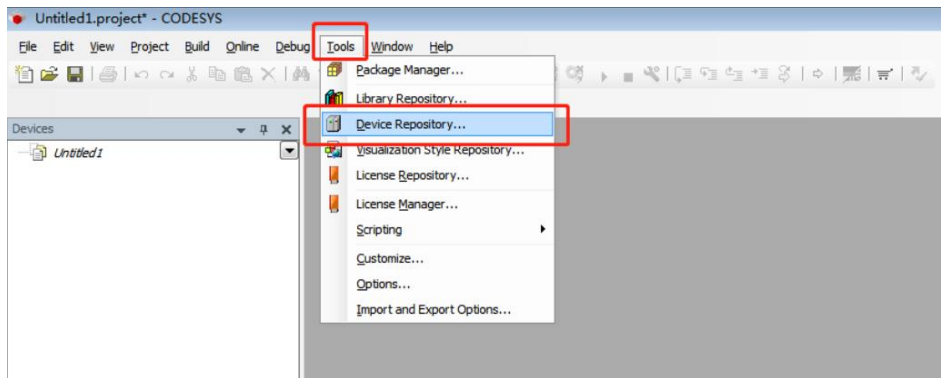

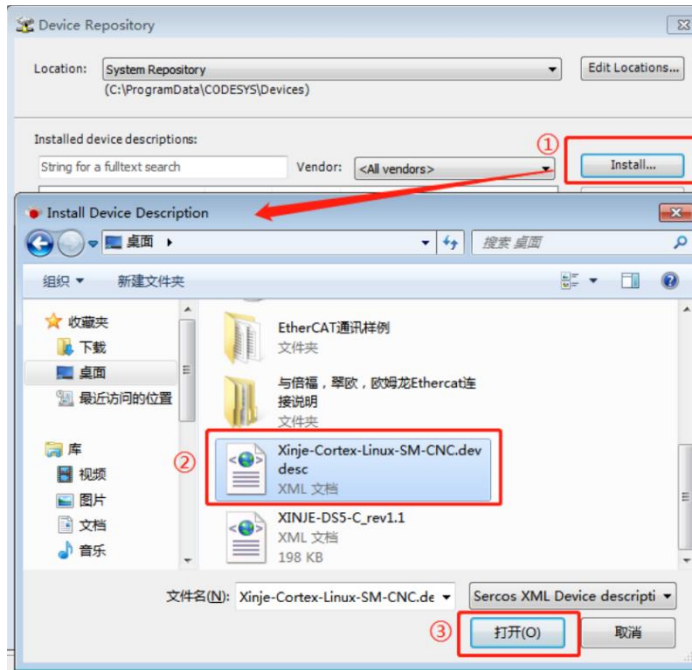

After opening, the installation is completed, as shown in the following figure. In the same way, install the slave XML file.

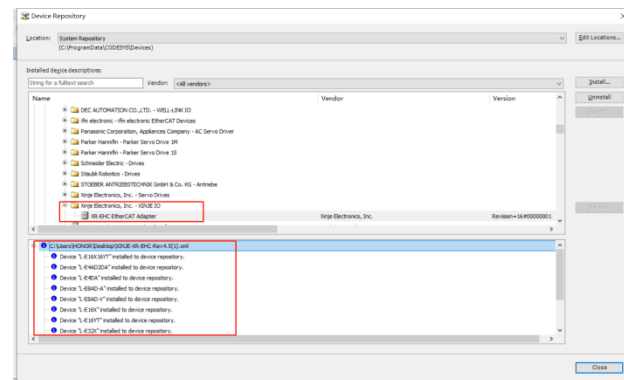
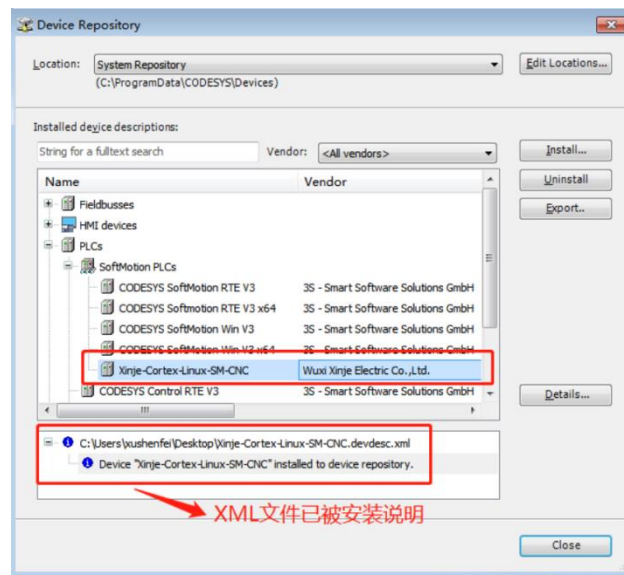

### 10-3-3. Add master station device

Right click Untitled, click Add Device, click Add Device, select PLCs—SoftMotionPLCs --Xinje –Cortex-Linux-SM-CNC, then click Add Device to add the PLC.

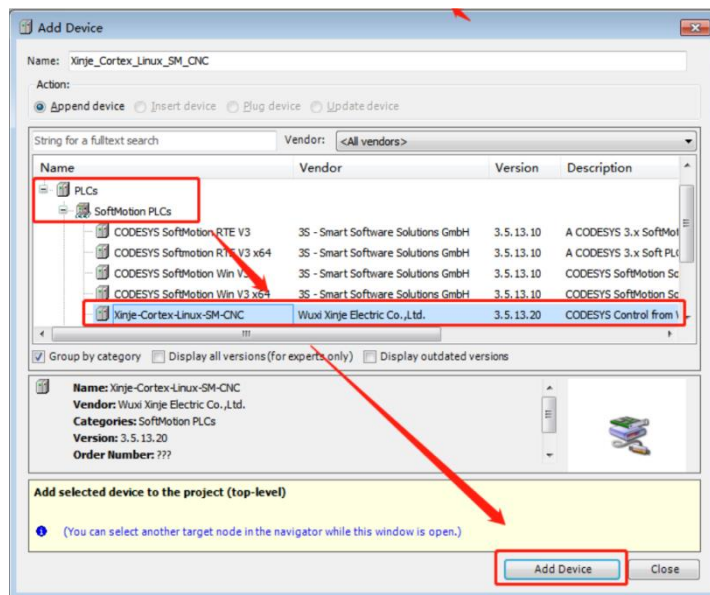
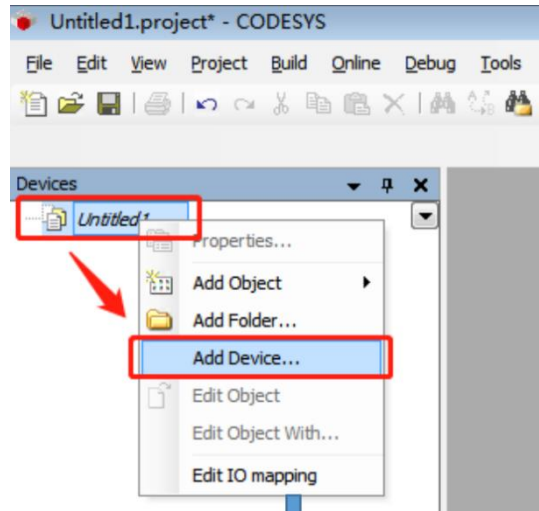

After the PLC is added, the Device Manager will appear on the right side of the interface, select Xinje –Cortex-Linux-SM-CNC, right-click, and click Add Device to add the device.

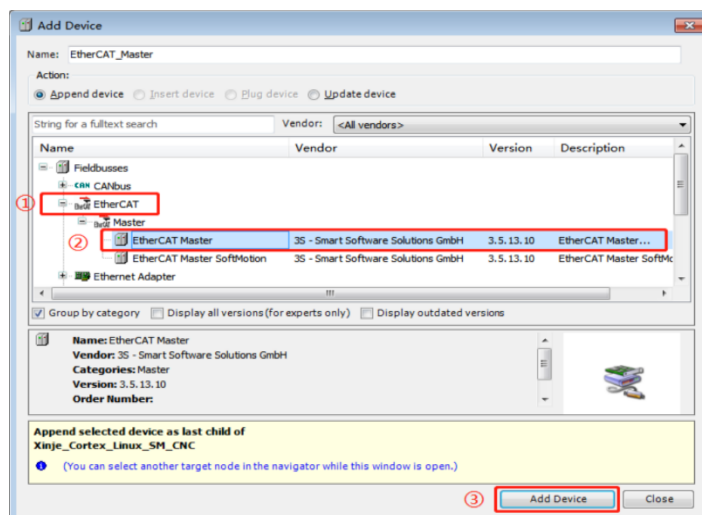

Adding the device is completed, as shown in the following figure:

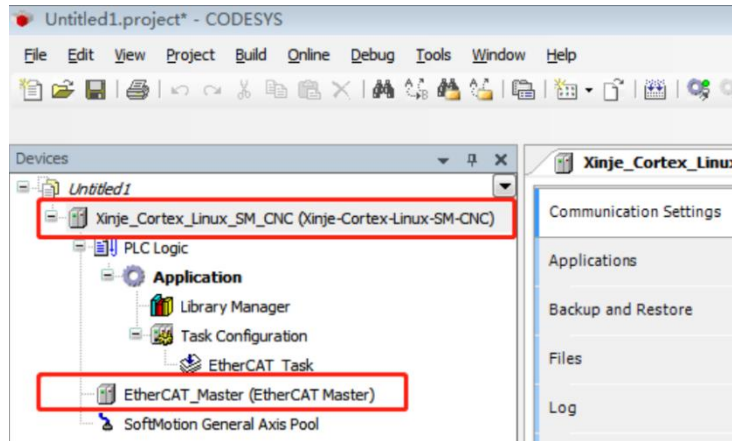

#### 10-3-4. Gateway Communication Settings

Double click Xinje\_Cortex\_Linux\_SM\_CNC, in the Communication Settings, click Scan network. Search for PLCs in the same network segment, and click OK after finding them. The device name of the PLC in the following figure is XINJE-XG3.

Note: Ethernet connection requires that the IP address of the connected device (PC) and the IP address of the PLC are in the same network segment. Therefore, before connecting, please confirm whether the IP address of the PC meets the requirements.

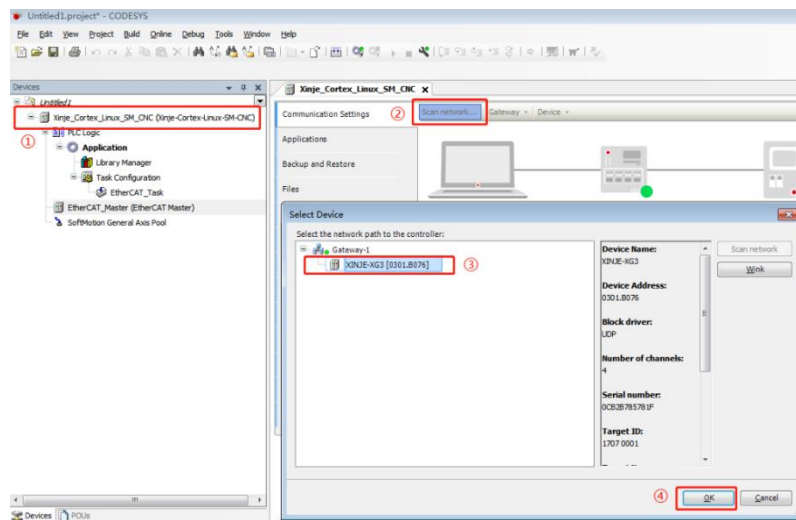

After the communication is successful, the following figure is shown:

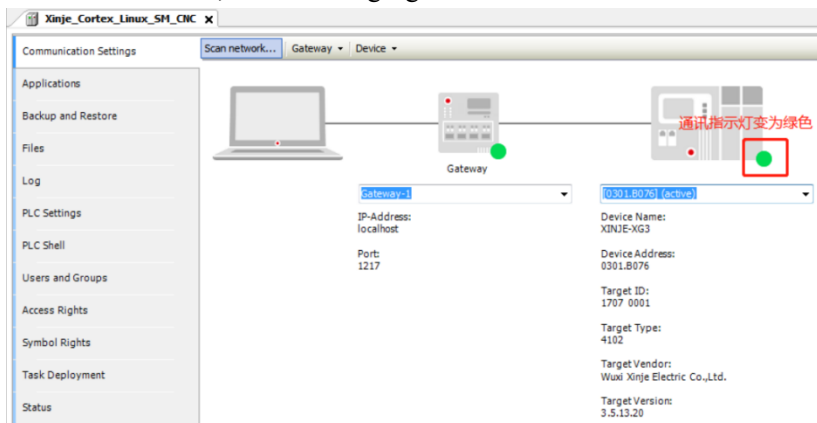



### 10-3-5. Scan the slave station device

In the Device tab, right click EtherCAT\_Master, click Scan For Devices to scan the EtherCAT slave station device.

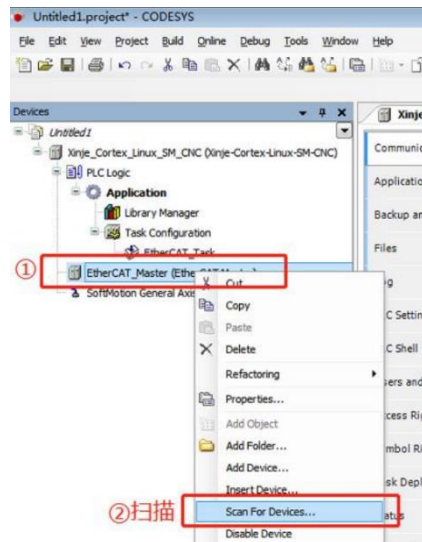

The scan result is shown in the figure below, click Copy All to Project to add all the scanned slaves to the project.

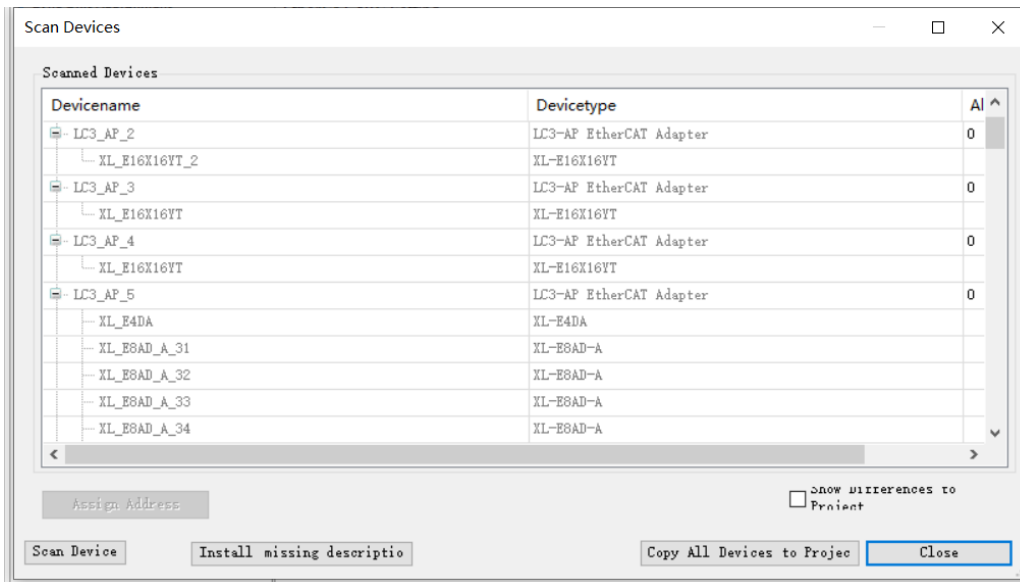

After the slave device is successfully added, the "Devices" column is as shown below:

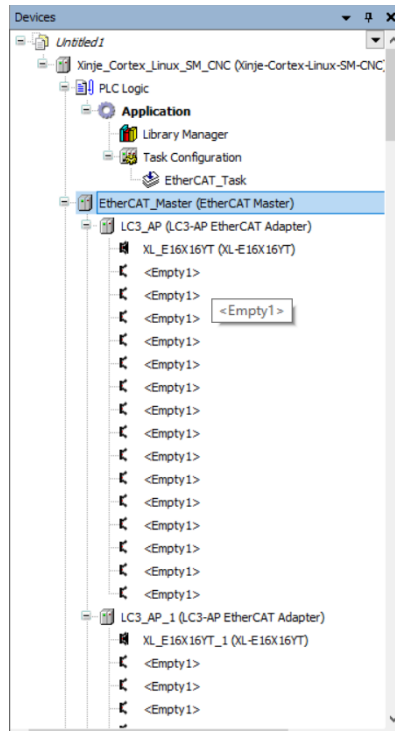

### 10-3-6. Set master station parameters

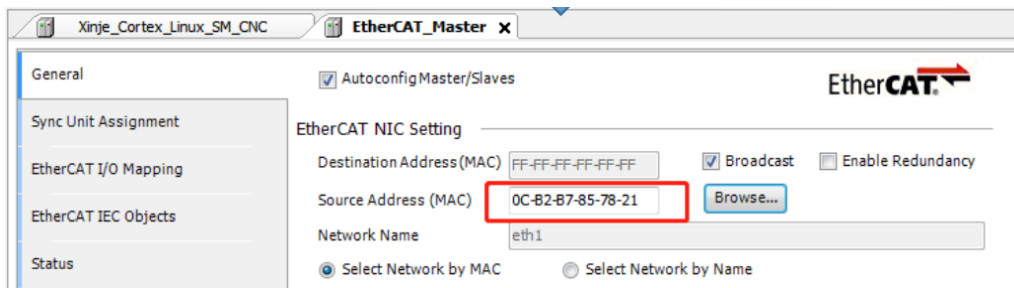
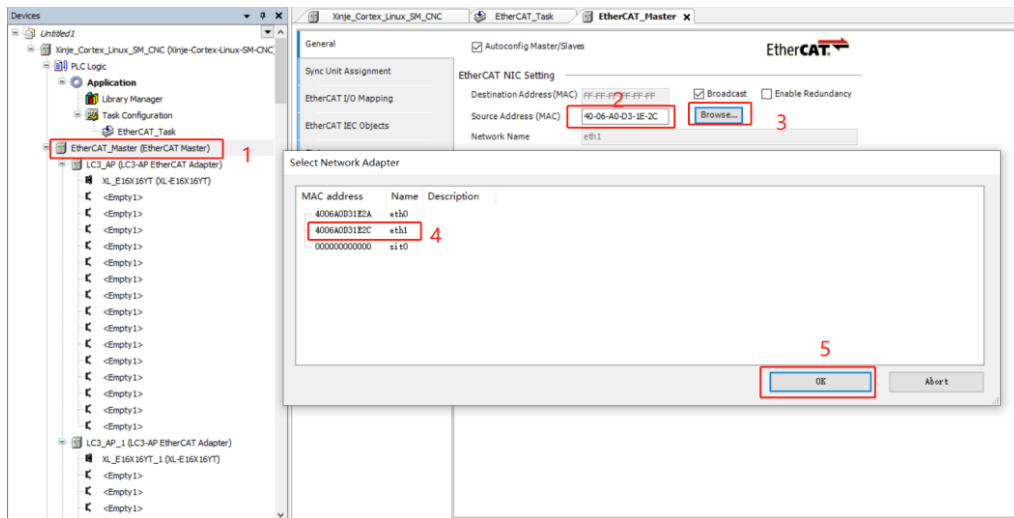

Modify the task cycle for the master station device:

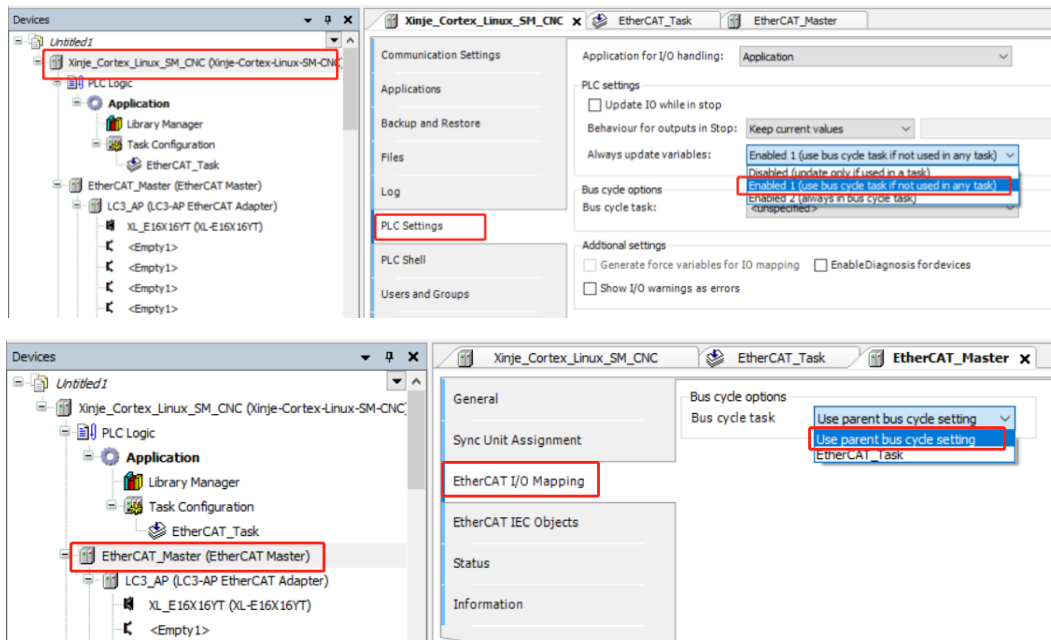

### 10-3-7. Program

Add POU. Right-click Application in the Devices column and select Add Object--POU.... After naming the added POU and selecting the programmatic method, click Add. In this example, the programming method continuous function chart (CFC) is selected.

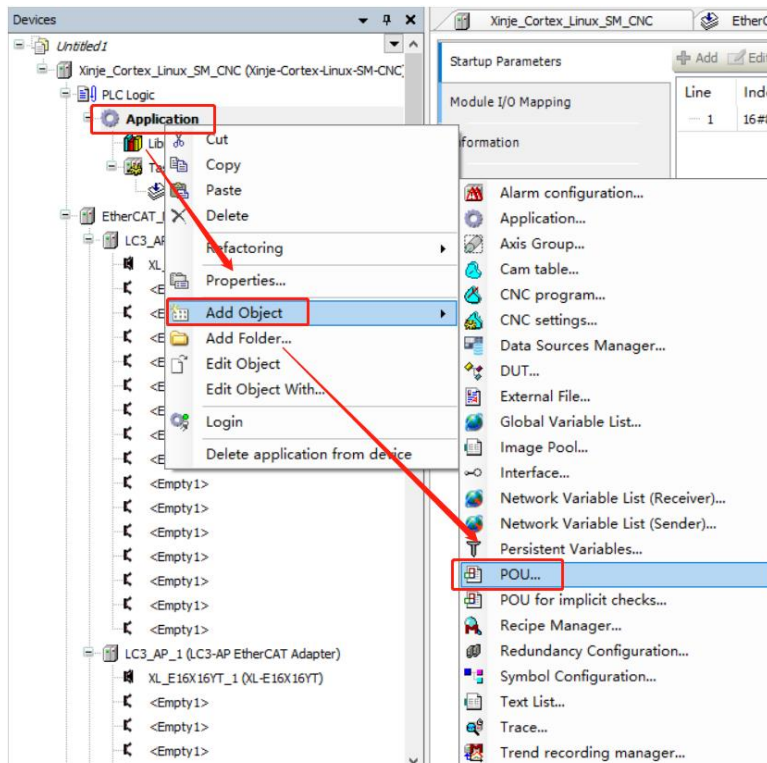

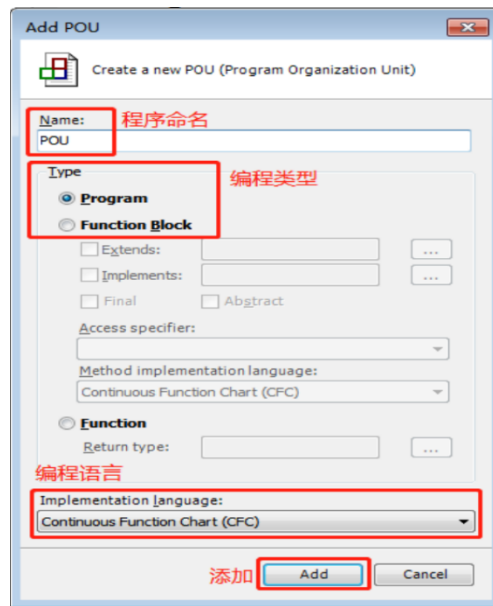

Double-click the added POU to program in the POU interface. Note: POU should be added to the task, because the subsequent compilation command will only compile the program added to the task. If a POU is created that is not added to the task, the compile command does not syntax check the POU. Right-click EtherCAT\_Task, select Add object--Program call, fill in "POU" in the Add Program call dialog box, and finally click Add.

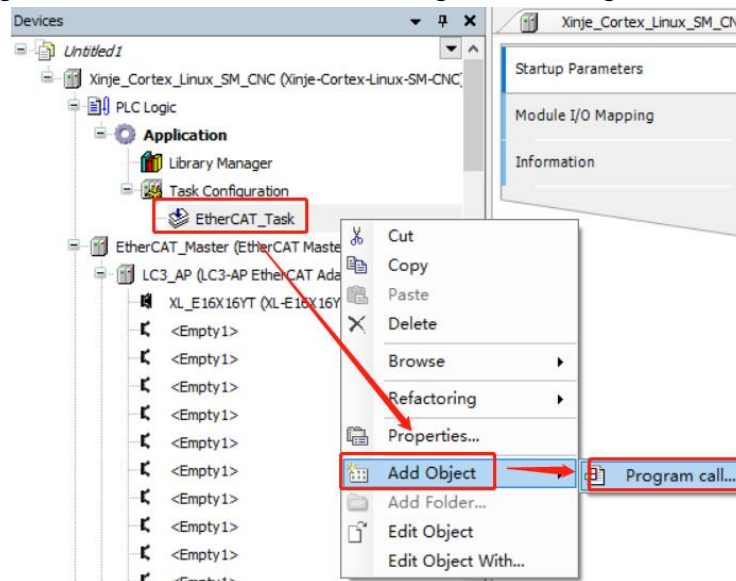

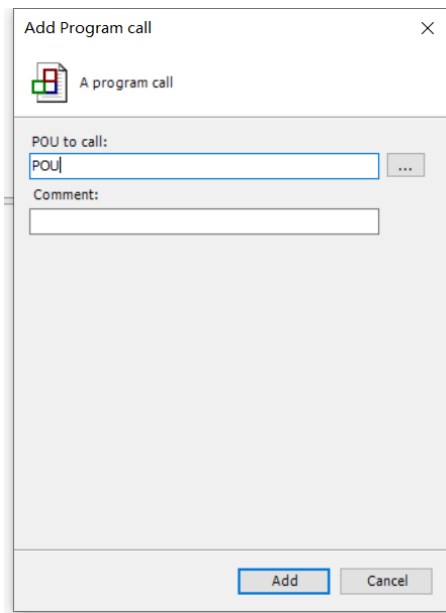

Define variables. There are two ways to try, one defines ordinary variables, and then establishes a connection. There is also a direct definition of the mapped address variable, QX0.1 is the mapped address of the module Y1 (see 10 for details) to establish a variable connection).

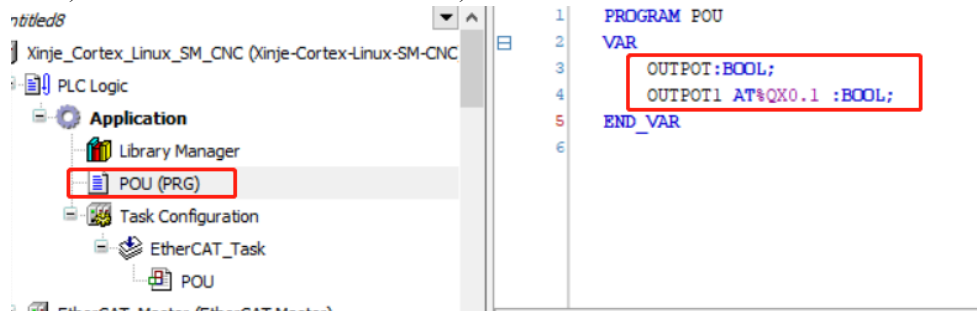



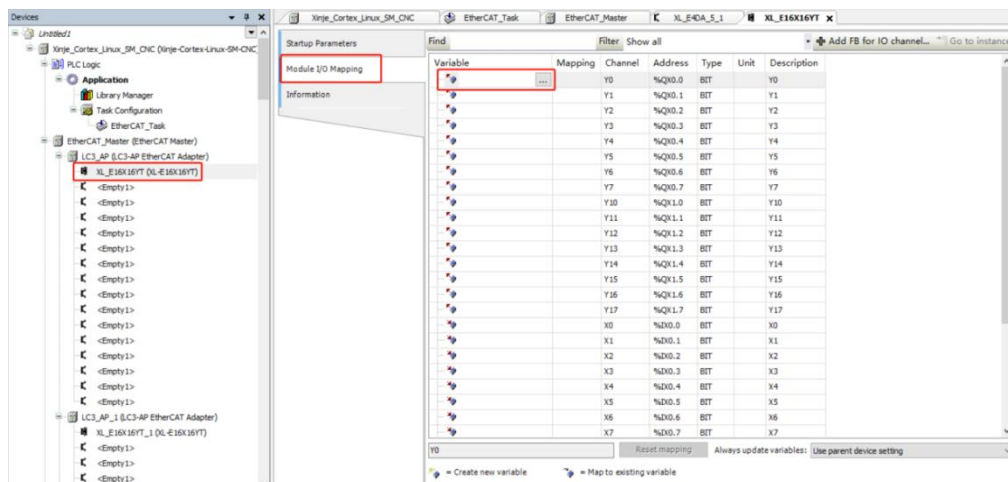

### 10-3-8. Create variable connection

Double-click the selected module, select Module I/O Mapping, each channel has a corresponding address, and the address can be specified when creating a variable. Or double-click the Y0 channel Variable.

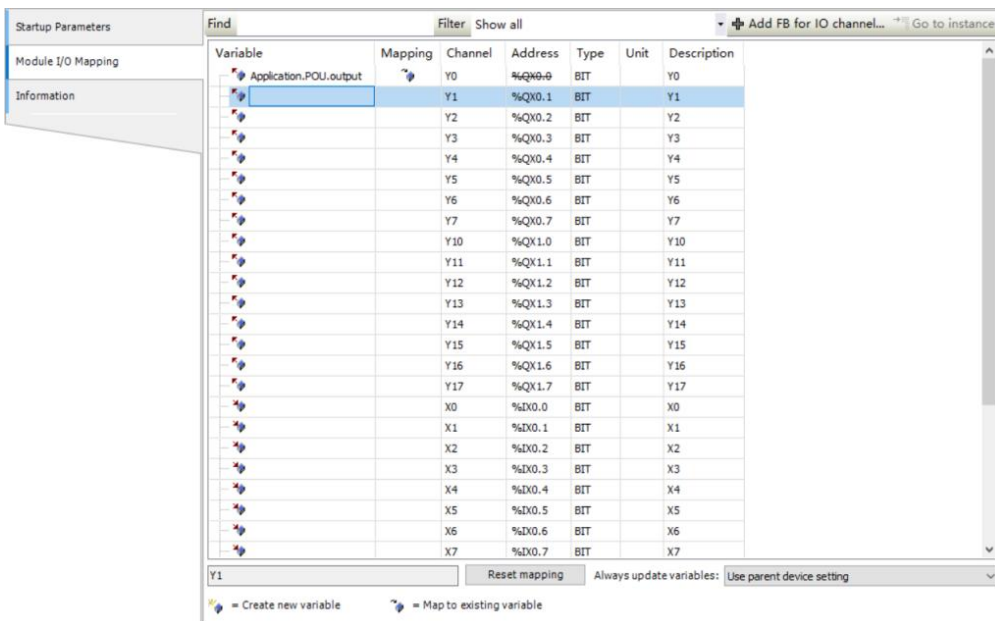
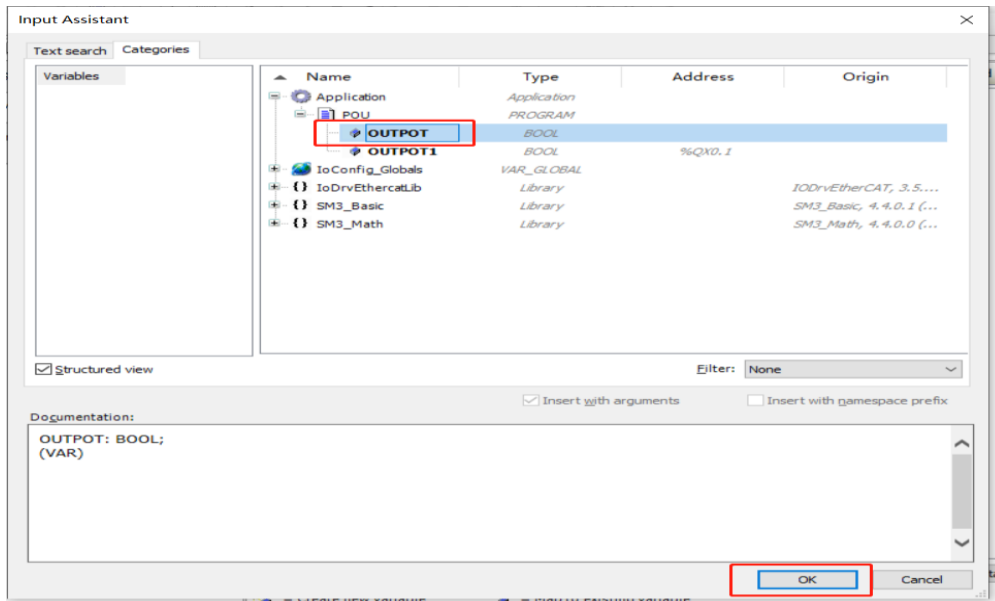

Select the normal variable you created.



Execute  compile,  log in,  run, the normal operation state is shown in the following figure:

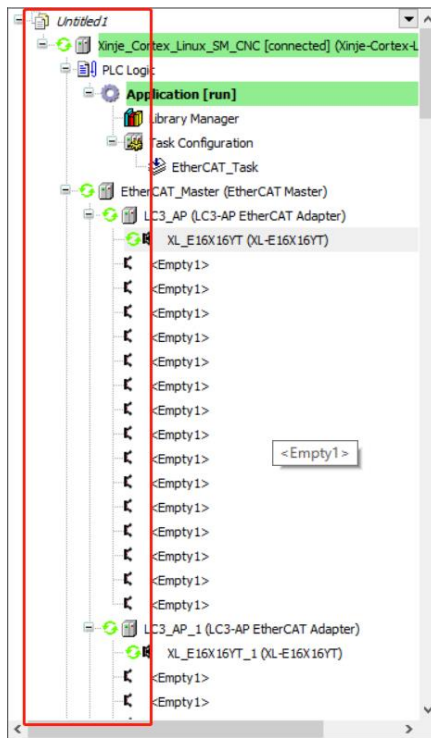

If cannot connecting after stop and run again, please click Reset warm.

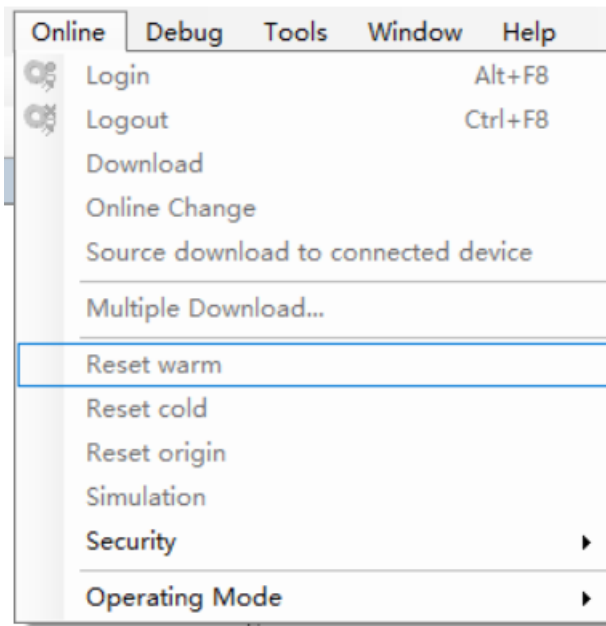

Write TRUE to the POU variable:

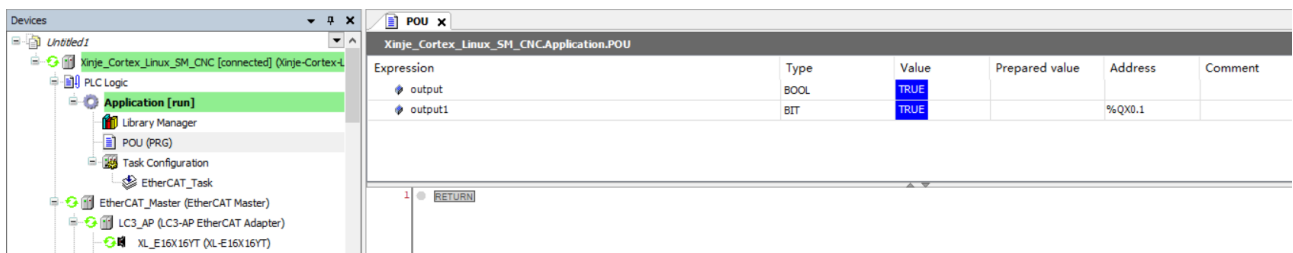

Remote IO module status display.

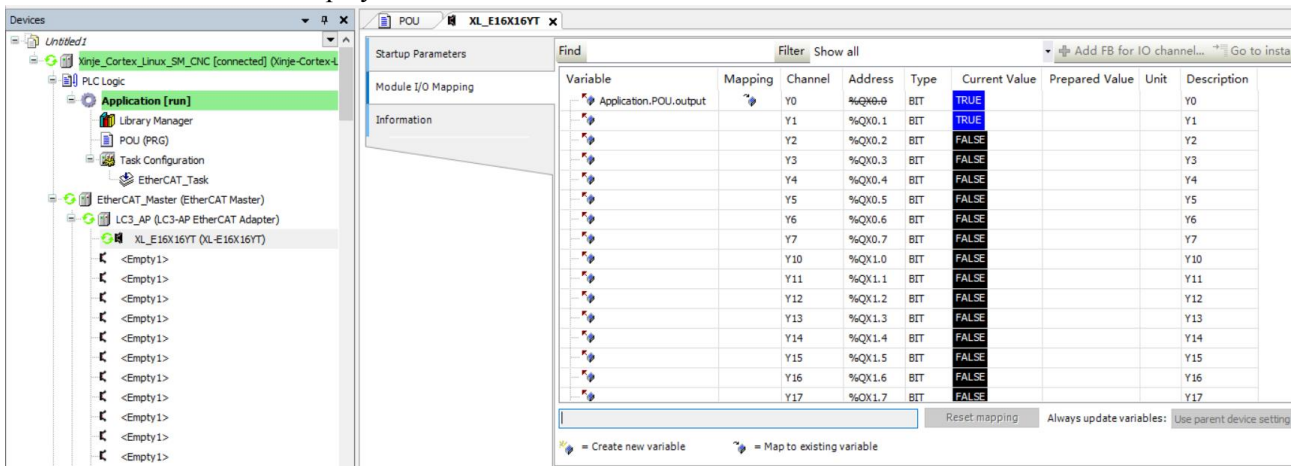

10-3-9. Slave station parameter

Double click LC3-AP slave station, select Enable Expert Settings.

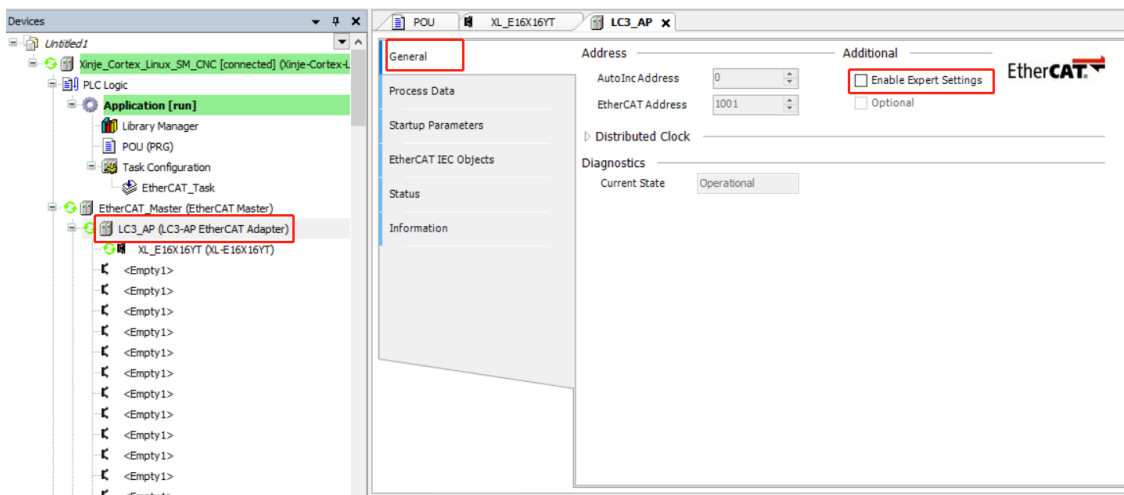

It will show Online and CoE Online.

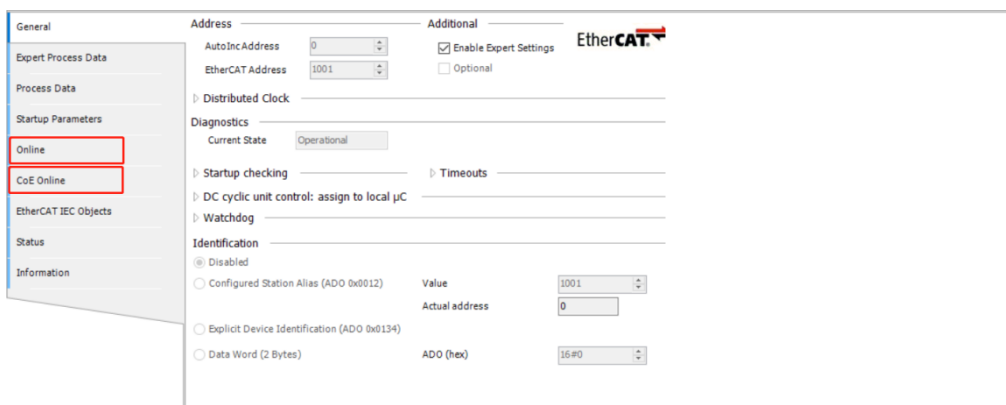



Click Online to check the slave station status, make sure it is in OP status.

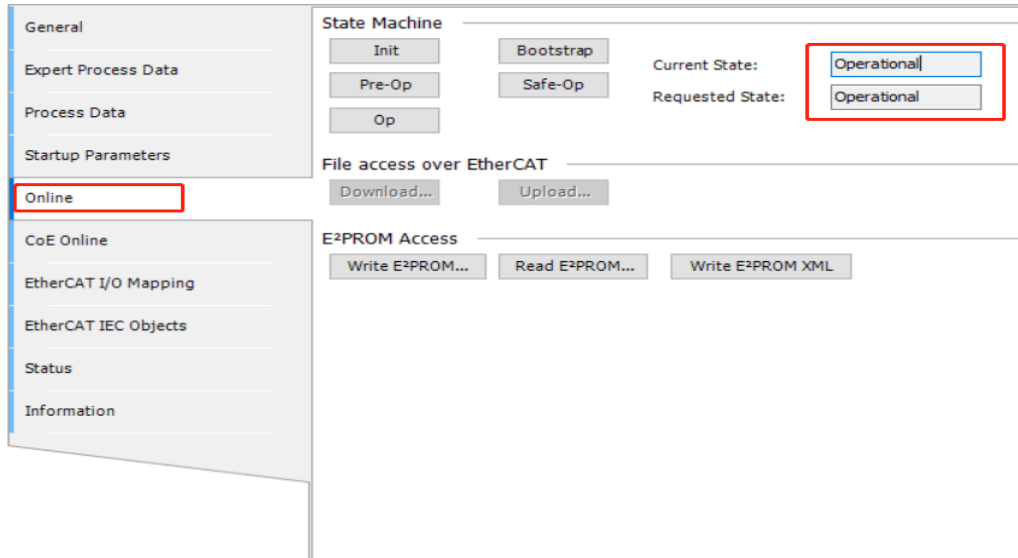

Click CoE Online, modify the module configuration parameters at 16#5000, modify the filter time and positive and negative logic. After the modification is completed, the slave station needs to be powered on again to take effect. For details, please refer to chapter 3-5.

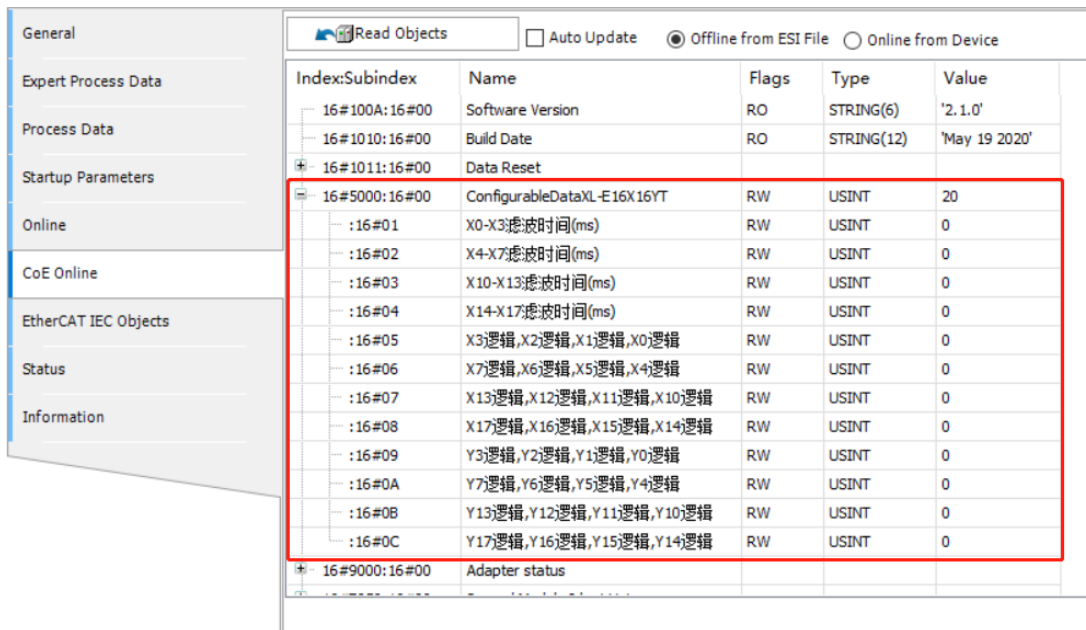

# XINJE



Xinje wechat ID

**WUXI XINJE ELECTRIC CO., LTD.**

No.816, Jianzhu West Road, Binhu District,  
Wuxi City, Jiangsu Province, China

214072

Tel: 400-885-0136

Fax: (510) 85111290

[www.xinje.com](http://www.xinje.com)