



**Z series expansion BD board
User manual**

Wuxi XINJE Electric Co., Ltd.

Data No. ZC 02 20210630EN 3.5

Catalog

1. CONFIGURATION	1
2. BD BOARD PRECISION.....	2
3. ANALOG I/O BD Z-4AD2DA-A-BD.....	3
3-1. FEATURES	3
3-2. GENERAL SPECIFICATIONS	3
3-3. EXTERNAL INSTALLATION AND WIRING	3
3-4. I/O ADDRESS	5
3-5. SOFTWARE CONFIGURATION	5
3-6. APPLICATION	6
4. ANALOG TEMPERATURE BD Z-3AD3PT-BD.....	7
4-1. FEATURES	7
4-2. GENERAL SPECIFICATIONS	7
4-3. INSTALLATION AND WIRING	7
4-4. I/O ADDRESS	8
4-5. SOFTWARE CONFIGURATION	8
4-6. APPLICATION	9
5. WEIGHING BD Z-NWT-BD.....	11
5-1. FEATURES	11
5-2. GENERAL SPECIFICATIONS	11
5-3. INSTALLATION AND WIRING	11
5-4. COMPOSITION OF WEIGHING SYSTEM	12
5-5. INTRODUCTION TO PRESSURE SENSORS	13
5-6. ANALOG-TO-DIGITAL CONVERSION DIAGRAM	13
5-7. ENTER THE ALLOCATION OF DEFINITION NUMBERS	14
5-8. MODULE SETTING.....	15
5-9. APPLICATION PROGRAM.....	17
6. COMMUNICATION BD Z-NES-BD	18
6-1. FEATURES	18
6-2. GENERAL SPECIFICATIONS	18
6-3. INSTALLATION AND WIRING	19
6-4. CONFIGURATION	19
7. I/O EXPANSION MODULE Z-NXMY-BD	24
7-1. FEATURES	24
7-2. GENERAL SPECIFICATIONS	24
7-3. TERMINALS.....	25
7-4. I/O ADDRESS ASSIGNMENT.....	25
7-5. INSTALLATION AND WIRING	26
7-6. SOFTWARE CONFIGURATION	28

8. THERMOCOUPLE TEMPERATURE CONTROL MODULE Z-4TC-BD	29
8-1. FEATURES	29
8-2. GENERAL SPECIFICATIONS	29
8-3. INSTALLATION AND WIRING	30
8-4. I/O ADDRESS ASSIGNMENT.....	31
8-5. SOFTWARE CONFIGURATION	31
8-6. APPLICATION PROGRAM.....	32
9. PT100 TEMPERATURE CONTROL MODULE Z-4PT3-BD	33
9-1. FEATURES	33
9-2. GENERAL SPECIFICATIONS	33
9-3. INSTALLATION AND WIRING	33
9-4. I/O ADDRESS ASSIGNMENT.....	34
9-5. SOFTWARE CONFIGURATION	35
9-6. APPLICATION PROGRAM.....	36
10. APPLICATION	36

1. Configuration

The steps to configure the BD:

1. Install the BD board in the ZG3 series controller:

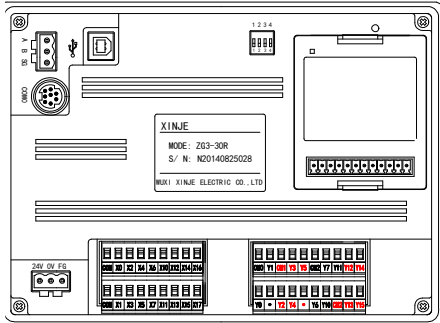

2. Connect XDPpro with the product, in the software, please click change PLC model, select ZG3-30. Then click BD in PLC project.

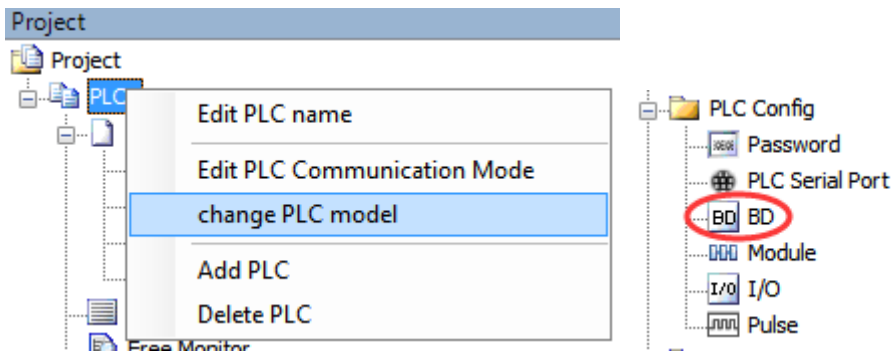

3. choose the BD board model and parameters such as voltage 0-10V, then click ok, download program in the PLC, and restart the PLC to make the setting effective.

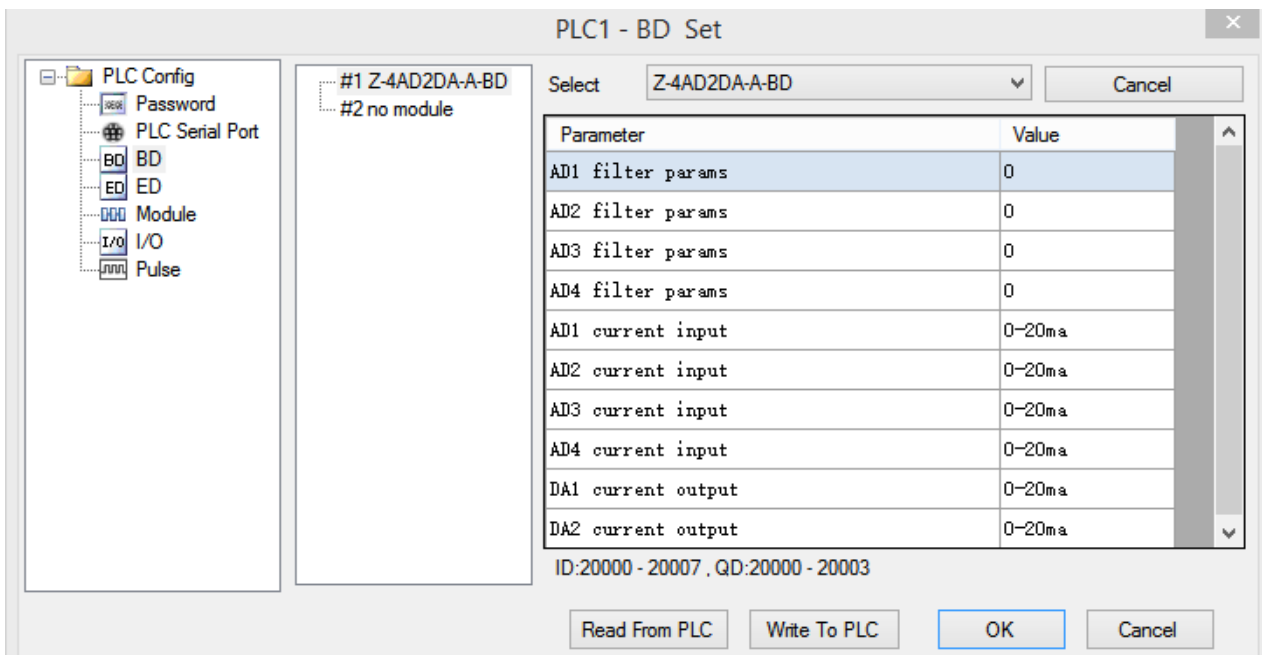

Note: please configure the BD board before using.

2. BD board precision

Here is an example to explain the precision of BD board.

Example: AD channel precision is 14-bit, analog input range is 0-5V or 0-10V. The transformed digital range is 0~16383. If the analog range is 0~5V, when the input voltage is 0V, the digital value is 0V, when the input voltage is 5V, the digital value is 16383. If the analog range is 0~10V, when the input voltage is 0V, the digital value is 0V, when the input voltage is 10V, the digital value is 16383. This is the relationship between input signal and transformed digital value.

For example, the pressure sensor signal is 0-10V, the sensor range is 0-15Mpa, the present pressure value will be shown on the HMI screen.

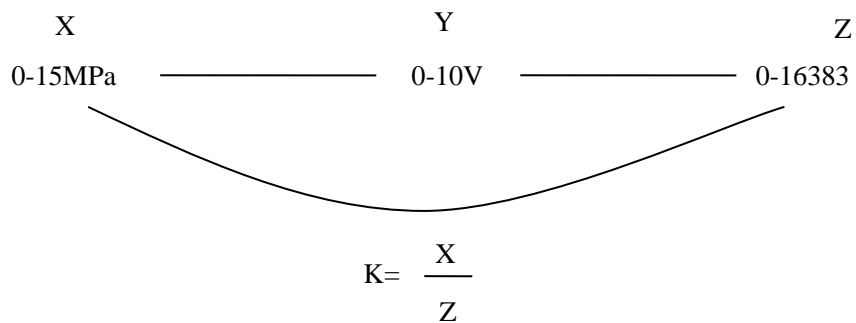

As the above diagram, it can get the result of K. K means the pressure value when digital value is 1 (please use float number calculation), then multiply ID with K to get the present pressure.

3. Analog I/O BD Z-4AD2DA-A-BD

3-1. Features

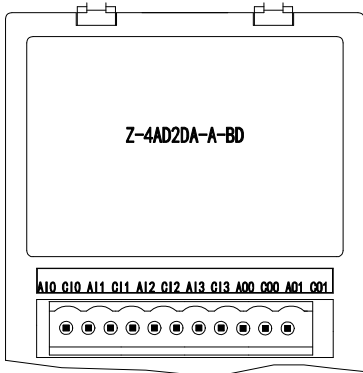

- 12-bit high precision analog input
- 10-bit high precision analog output
- 4 channels 0~20mA or 4~20mA analog input
- 2 channels 0~20mA or 4~20mA analog output
- It needs external power supply for current output

3-2. General specifications

Item	Current input	Current output
Analog input range	0~20mA, 4~20mA (input resistor 125Ω)	-
Analog output range	-	DC0~20mA, 4~20mA (external load resistor less than 500Ω)
Resolution	1/4096 (12Bit);	1/1024 (10Bit);
Digital input range	12-bit binary number (0~4095)	-
Digital output range	-	10-bit binary number (0~1023)
Integrated precision	±0.8% of full scale	
Transformed time	1ms/1 channel	1ms/1 channel
Insulation	There is no insulation between each I/O channel, there is insulation between I/O and internal circuit	
Points occupy	0 points (the data are operated in data register, it will not be limited by PLC max I/O points)	

3-3. External installation and wiring

(1) BD board installation:

Open the BD cover of ZG3 controller, insert the BD board into the pins, then close the cover.

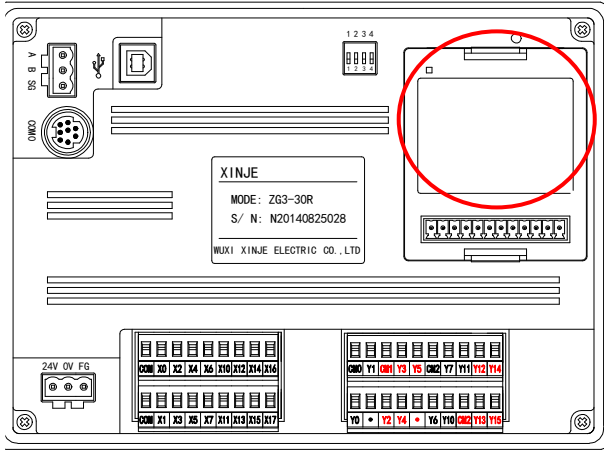

(2) Terminals:



Channel	Terminal	Signal
CH0	AI0	CH0 current analog input
	CI0	CH0 common terminal of analog input
CH1	AI1	CH1 current analog input
	CI1	CH1 common terminal of analog input
CH2	AI2	CH2 current analog input
	CI2	CH2 common terminal of analog input
CH3	AI3	CH3 current analog input
	CI3	CH3 common terminal of analog input
CH0	A00	CH0 current analog output
	C00	CH0 common terminal of analog output
CH1	A01	CH1 current analog output
	C01	CH1 common terminal of analog output

(3)Wiring method:

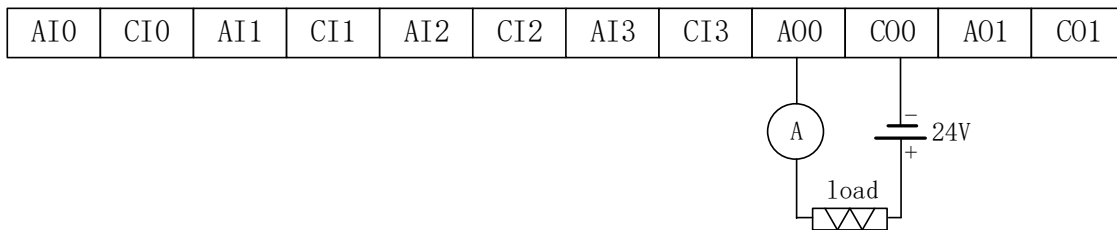

Note:

The first 4 channels are for AD which can collect analog current 0~20mA or 4~20mA, AI0 connects to signal+, CI0 connects to signal-.

The last 2 channels are for DA which can output the current 0~20mA or 4~20mA. Please see the above wiring diagram, the ammeter is for testing, it no needs to connect in actual application.

It needs to connect external DC24V power supply for current output channel.

3-4. I/O address

This BD board will not occupy I/O units, the transformed value will send to PLC register, the PLC register of each channel are as the following:

Channel	AD signal
0CH	ID20000
1CH	ID20001
2CH	ID20002
3CH	ID20003
Channel	DA signal
0CH	QD20000
1CH	QD20001

Note:

this BD board has no PID function.

when the input data is over 1023, the DA output will keep 20mA.

3-5. Software configuration

Open the XDPpro software(Version V3.5.2 or later), click the BD setting in the left menu:

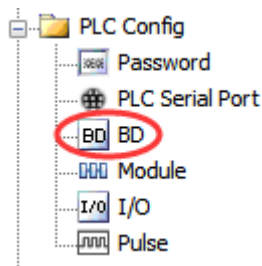

Choose the BD board model in the window:

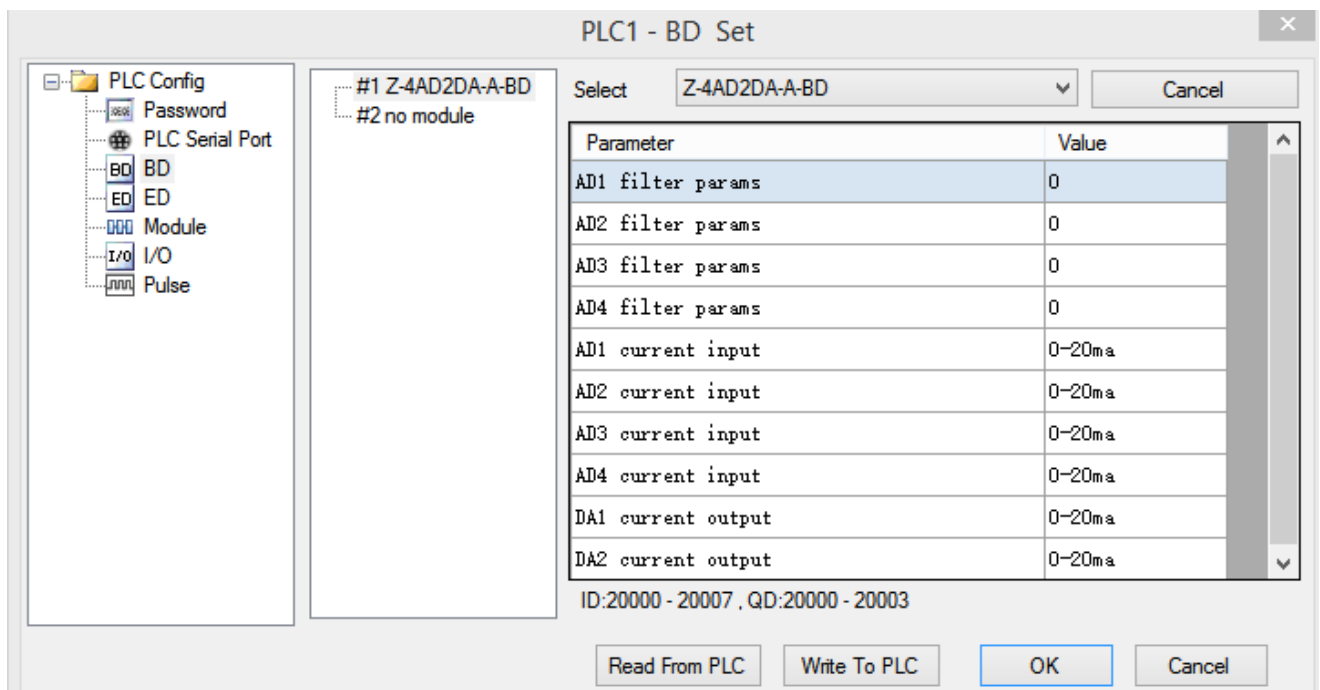

choose Z-4AD2DA-A-BD

choose AD channel current input mode and filter coefficient, current output mode.

Click ok to confirm the setting, then download the user program in the PLC and repower on the PLC.

3-6. Application

Example: read 2 channels data, write in 2 channels data.

The program:

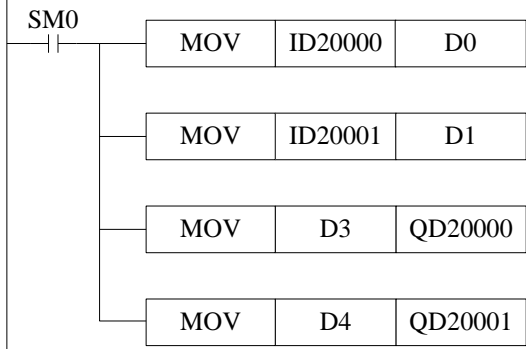

Explanations:

SM0 is always ON coil, it is ON when PLC is running.

write the channel 0 data in register D0;

write the channel 1 data in register D1;

move the register D3 data to channel 0 for outputting;

move the register D4 data to channel 1 for outputting.

4. Analog temperature BD Z-3AD3PT-BD

4-1. Features

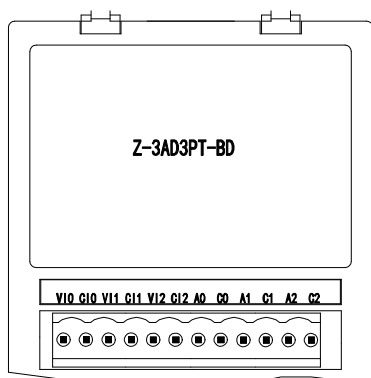

- 12-bit analog input
- 3 channels voltage 0~10V or 0~5V input.
- 3 channels Pt100(2-wire) temperature sensor input.

4-2. General specifications

Item	Voltage input	Temperature input
Analog input range	0~5V, 0~10V (input resistor 13.3kΩ)	Pt100 (2-wire) sensor
Temperature range	-	-100~500°C
Resolution	1/4096 (12Bit); the transformed data is saved in PLC(12-bit) in hex format	0.1°C
Digital input range	12-bit binary numbers (0~4095)	-1000~5000
Integrated accuracy	±0.8% of the full scale	
Conversion time	1ms/1 channel	1ms/1 channel
Insulation	There is no insulation between each I/O channel, there is insulation between I/O and internal circuit	
Point occupy	0 points (the data are operated in data register, it will not be limited by PLC max I/O points)	

4-3. Installation and wiring

(1) BD board installation:

Open the BD cover of ZG3 controller, insert the BD board into the pins, then close the cover.

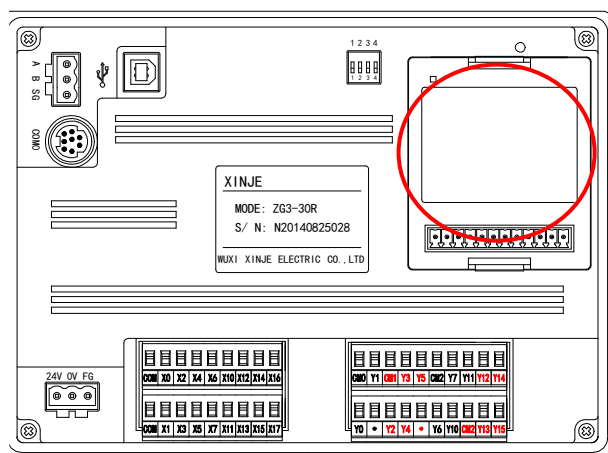

VI0	CI0	VI1	CI1	VI2	CI2	A0	C0	A1	C1	A2	C2
-----	-----	-----	-----	-----	-----	----	----	----	----	----	----

Channel	Terminal	Signal
CH0	VI0	0CH voltage input
	CI0	0CH voltage input common terminal
CH1	VI1	1CH voltage input
	CI1	1CH voltage input common terminal
CH2	VI2	2CH voltage input
	CI2	2CH voltage input common terminal
CH0	A0	0CH temperature input
	C0	0CH input common terminal
CH1	A1	1CH temperature input
	C1	1CH input common terminal
CH2	A2	2CH temperature input
	C2	2CH input common terminal

(3) Wiring method:

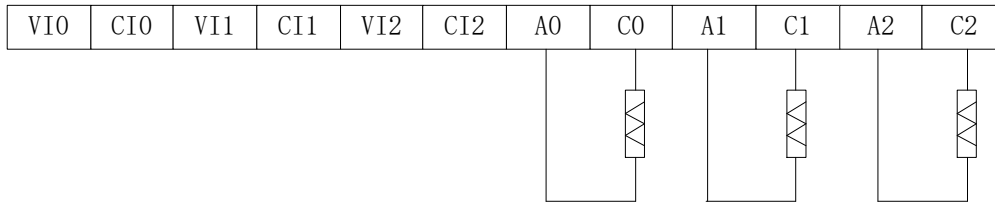

Notes:

The first 3 channels are for AD input, it can input voltage signal 0~5V or 0~10V. VI0 connects to signal+, CI0 connects to signal-.

The last 3 channels are for PT100 sensor signal input. A0 connects to PT100 signal+, C0 connects to PT100 signal-.

4-4. I/O address

This BD board will not occupy I/O units, the transformed value will send to PLC register, the PLC register of each channel are as the following:

Channel	AD signal
0CH	ID20000
1CH	ID20001
2CH	ID20002
Channel	PT100 signal
0CH	ID20003
1CH	ID20004
2CH	ID20005

4-5. Software configuration

Open the XDPpro software, click the BD setting in the left menu:

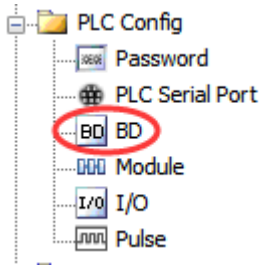

Choose the BD board model in the window:

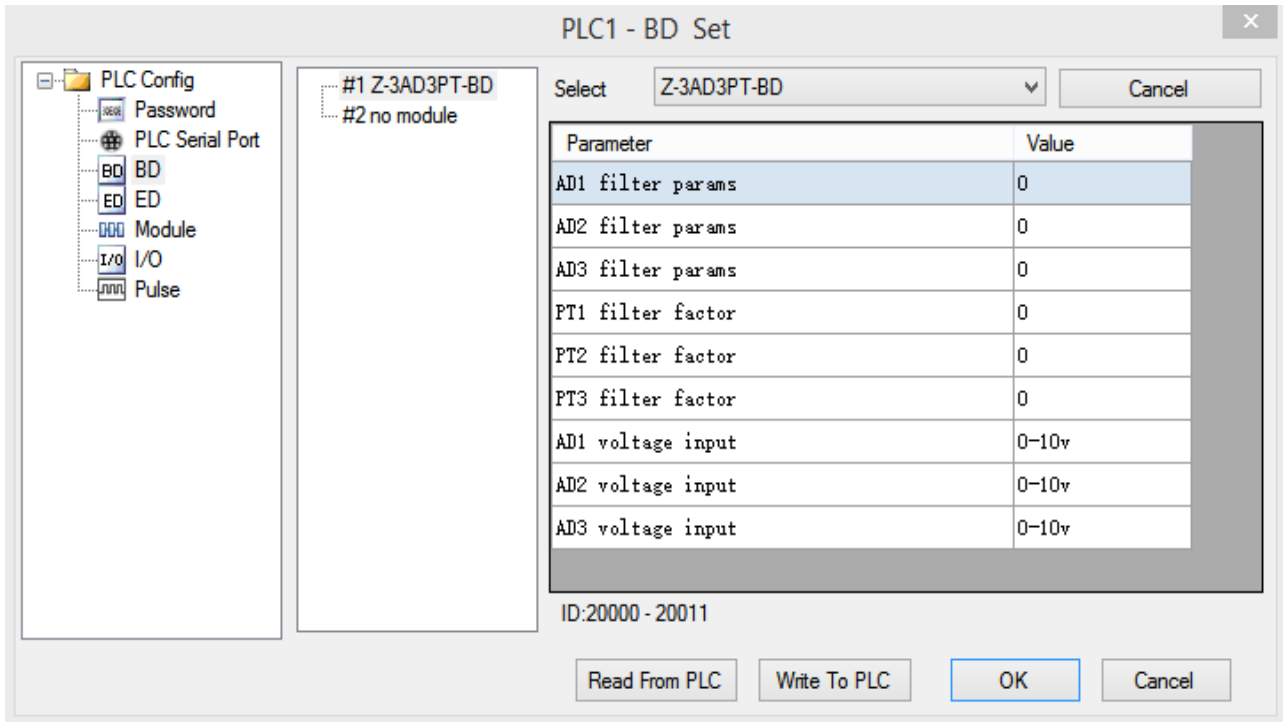

choose Z-3AD3PT-BD.

Set the AD channel voltage input mode, filter coefficient and PT channel filter coefficient.

Click ok to confirm the settings, then download the program in the PLC, repower on the PLC and run the program.

4-6. Application

Read 2 channels analog data, read 1 channel temperature value.

The program:

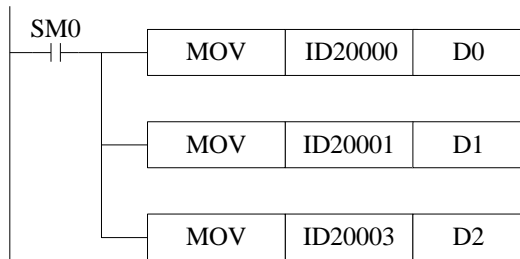

Explanation:

SM0 is always ON coil, it is ON when PLC is running.

PLC starts to run, write channel 0 analog value to register D0;

Write channel 1 analog value to register D1;
Write channel 0 temperature value to register D2.

5. Weighing BD Z-nWT-BD

5-1. Features

Weighing BD board Z-1wT-BD and Z-2wT-BD, as the expansion BD board of ZG series integral controller, can be used to detect DC voltage signal of 0~10mV or collect voltage signal of pressure sensor, and convert analog voltage value into digital value through A/D and carry out calculation.

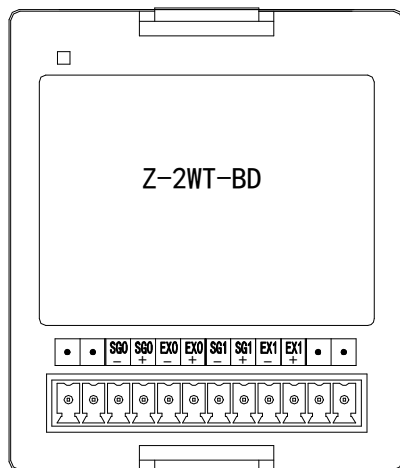

- It can collect analog voltage signals of 1 or 2 pressure sensors.
- It can detect the voltage signal of 0 ~ 10 mV.
- 24-bit high precision A/D conversion

5-2. General specifications

Input range	DC0~10mV (sensor 2mv/v)
A/D real resolution	1/1048575 (20Bit)
Max display resolution	1/300000
Non-linear	0.01% F.S
Transformation speed	150/ 300/ 450times/second(optional)
Power supply	AC220V±10% 50/60Hz
Sensor power supply	5VDC/120mA, can parallel 4 pieces of 350Ω weighing sensor
Installation	Directly mounted on the back of the integral controller
Working environment	No corrosive gas
Ambient temperature	-10°C~50°C
Ambient humidity	5~95%RH (no condensation)
Software version	V3.5.2 and higher version

5-3. Installation and wiring

(1) BD board installation:

Open the BD cover of ZG3 controller, insert the BD board into the pins, then close the cover.

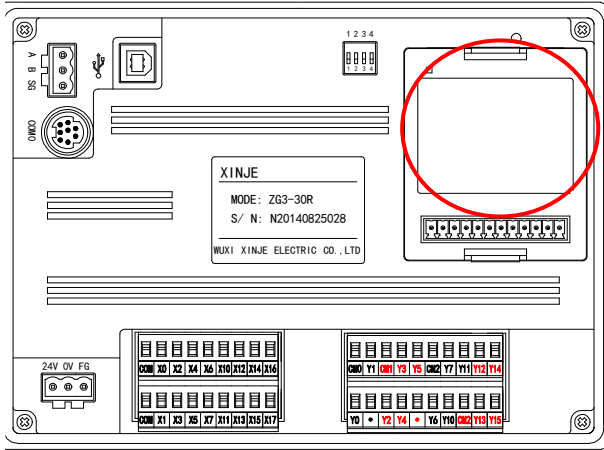

(2) Terminals:

Z-1WT-BD:



Z-2WT-BD:

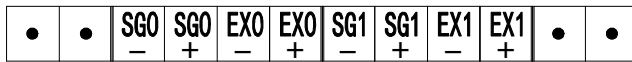

Channel	Terminal	Signal	Meaning
CH1	EX0+	Excitation +	Connect to sensor power supply input
	EX0-	Excitation -	
	SG0+	Signal+	Connect to sensor signal output
	SG0-	Signal-	
CH2	EX1+	Excitation +	Connect to sensor power supply input
	EX1-	Excitation -	
	SG1+	Signal+	Connect to sensor signal output
	SG1-	Signal-	

5-4. Composition of weighing system

Complete industrial weighing system mainly includes the following components:

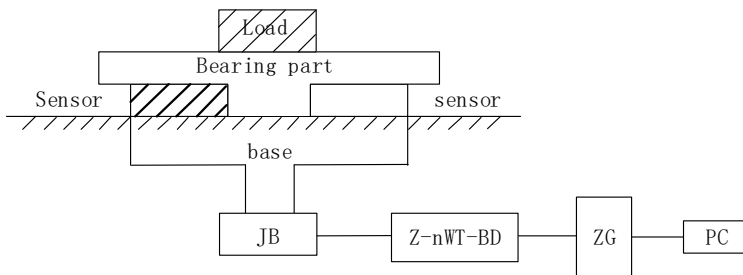

The picture shows the setup of a weighing system with Z-nWT-BD.

Name	Function
Load-bearing element	It used to support loads to be weighed. Including platform, hopper, air transport vehicles, containers and so on
Pressure sensor	A pressure sensor is a measurement sensor that converts a physical value (i.e. weight) into a proportional electrical signal
Assemble component	The assembly element ensures the correct operation of the load cell, and the assembly element and the guide element prevent heavy load, which can cause measurement errors and damage to the load cell. The excess load is caused by a force (lateral force) in the direction of the undesigned load cell spring.
Junction box	A junction box (JB) is used to bring together the signal lines from several parallel transducers.
Z-nWT-BD	Z-nWT-BD can be used as an electronic evaluation device, which obtains the signal from the pressure sensor and makes further evaluation.

5-5. Introduction to pressure Sensors

The pressure sensor is based on the principle of resistance strain effect. Its schematic diagram is as follows:

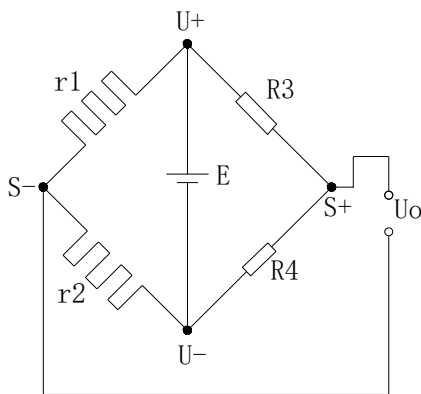

r_1 and r_2 are strain resistors and form a bridge circuit with two fixed resistors r_3 and r_4 . Because the resistance values of r_1 and r_2 change, the bridge loses balance, and the unbalanced voltage U_o is obtained as the output signal of the sensor.

$U +$ and $U -$ are the positive and negative terminals of the sensor power supply respectively. The power supply can be supplied by 5V power supply provided by this module or external power supply.

$S +$ and $S -$ are the positive and negative terminals of the sensor output signal respectively. The output millivolt voltage signal is connected to this module, which can detect the pressure.

5-6. Analog-to-digital conversion diagram

The relationship between the analog input voltage and the converted digital input voltage is shown in the figure below:

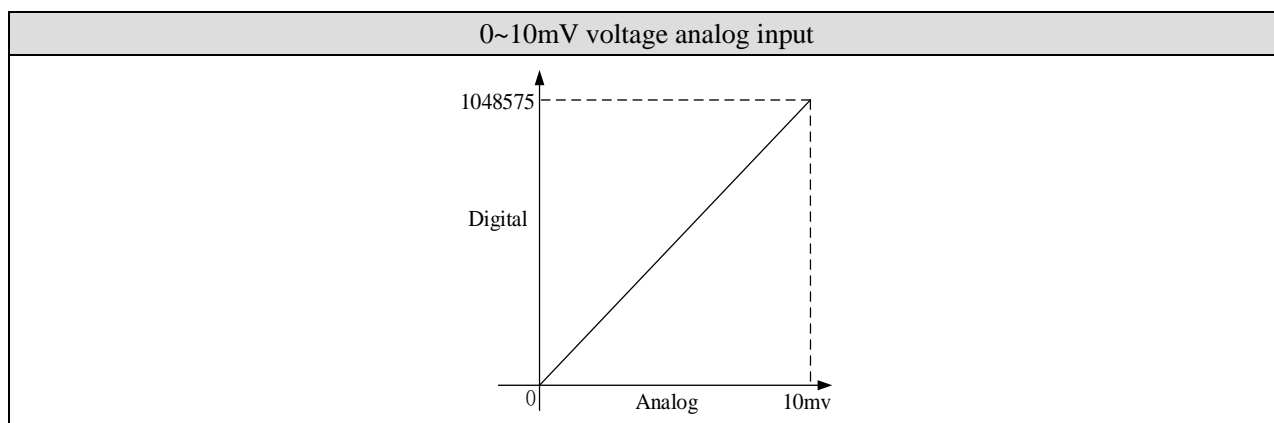

5-7. Enter the allocation of definition numbers

component	Channel	Address	Explanation	Note
Output coil	CH1	Y20000	Filter level	
		Y20001	Reset	
		Y20002	Zero point calibration	
		Y20003	Gain calibration	
	CH2	Y20004	Filter level	
		Y20005	Reset	
		Y20006	Zero point calibration	
		Y20007	Gain calibration	
ALL	Y20020	Back to out of factory value		
Input coil	CH1	X20000	Stable flag	
		X20001	Overflow flag	
		X20002	Calibration success flag	
		X20003	Calibration failure flag	
	CH2	X20004	Stable flag	
		X20005	Overflow flag	
		X20006	Calibration success flag	
		X20007	Calibration failure flag	
Input register	CH1	ID20000	Present weight	Double words
		ID20002	Present digital value and present input voltage	Double words
	CH2	ID20004	Present weight	Double words
		ID20006	Present digital value/present input voltage	Double words

【Note】 : Z-1WT-BD only has CH1.

filter level	ON: filter level A, OFF: filter level B
Reset	The reset is valid in the reset range, not save zero point
Zero point calibration	To calibrate the system zero point
Gain calibration	To calibrate system linear
Stable flag	The signal output is effective when meeting the stable range and time
Overflow flag	When the signal voltage larger than 10mv,this signal output is effective.
Calibration success flag	The signal output is effective when zero point calibration and gain calibration succeeded.
Calibration failure flag	The signal output is effective when zero point calibration and gain calibration failed (the detailed reasons please check module application error info)
Present digital value/present input voltage	Switch through upper device, when it is switched to present input voltage, the unit is mv, the decimal is 4 bits.

5-8. module setting

Module parameter list

Address	Content	Explanation		Features
K0	Zero point tracking range	Range: 0~9 Value: 5	All the channels	Word R/W
K1	Zero point tracking time	Range: 500~5000 (ms) Value: 2000		Word R/W
K2	Reset range	Range: 1~99 (%) Value: 50		Word R/W
K3	Stable range	Range: 1~99 Value: 3		Word R/W
K4	Stable time	Range: 10~5000 (ms) Value: 100		Word R/W
K5	Filter level A	Range: 0~9 Value: 3		Word R/W
K6	Filter level B	Range: 0~9 Value: 5		Word R/W
K7~K9	-			
K10	Zero calibration voltage return value	Return the current sensor input voltage value after calibration zero	CH1	Dword R
K12	Gain calibration value/gain calibration voltage return value	Gain calibration, as the weight input value; When not calibrated, as the return relative voltage value		Dword R/W
K14	CH1 min scale division	Range: 1,2,5,10,20,50		Word R/W
K15	CH1 max range	Range: <1000000		Dword R/W
K17	-			
K20	Zero calibration voltage return value	Return the current sensor input voltage value after calibration zero	CH2	Dword R
K22	Gain calibration	Gain calibration, as the weight input value;		Dword R/W

Address	Content	Explanation	Features
	value/gain calibration voltage return value	When not calibrated, as the return relative voltage value	
K24	CH2 min scale division	Range: 1,2,5,10,20,50	Word R/W
K25	CH2 max range	Range: <1000000	Dword R/W
K27	-		

Setting of weighing unit :(take channel 1 of BD board as an example)

Write in weight through instruction TO. For example, the object weight is 1kg, write in 1 means the unit is kg, write in 1000 means the unit is g, write in 10000 means the unit is 0.1g. resolution=1kg/write in digital value.

Calibration:

Please calibrate the pressure sensor for the first time using.

Take module channel 1 as an example:

Step 1:

Confirm whether the module and sensor work properly.

Judgment method:

First, monitor whether the overflow flag X20001 is OFF state. If it is ON, the sensor is not connected or the sensor is damaged.

Second, using the software to monitor whether ID20002 value fluctuates following sensor (fluctuation range is related to sensor range), and pressure value increased when increasing the load, if there are value but increase the load stress value decreases, that means (1) sensor installed opposite, please adjust the sensor position or exchange +/- of sensor output signal; (2) The incoming voltage signal has been overflow, reducing the load appropriately.

Step 2:

Make the sensor no load, after the stable flag X20000 is ON, set ON zero-point calibration Y20002. X20002 ON means the zero-point calibration is successful. If after few seconds, X10003 is ON, that means zero-point calibration is failed.

Step 3:

Put the load whose weight is known on the scale, write the weight through TO instruction, after stable flag X10000 is ON, set ON gain calibration Y10003, X10002 ON means calibration is successful, shut off Y10003. If after few seconds, X10003 is ON, that means zero-point calibration is failed.

Step 4:

Hereto, the calibration finished. The module will automatic adjust the result according to the idle load value and calibration value when weighing, and finally get the correct weight.

5-9. Application program

Take module 1 as an example:

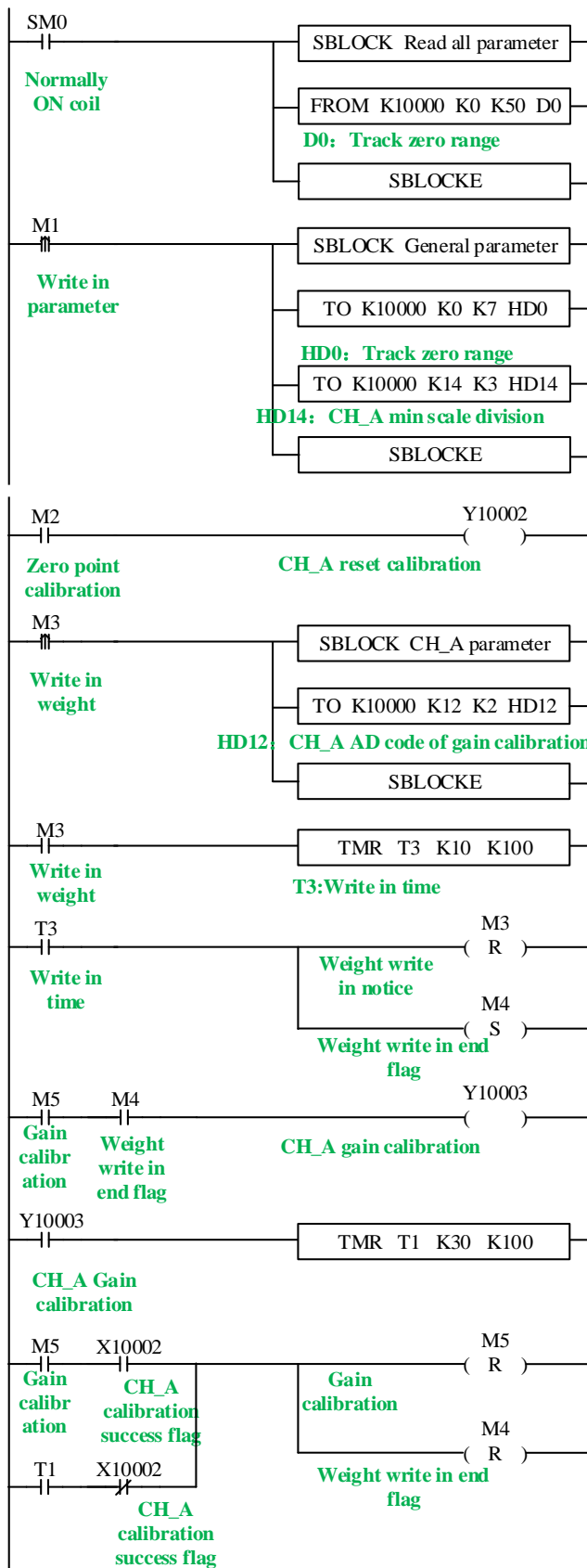

Explanation:

Read all the parameters and write in general parameters through FROM/TO instruction.

Set ON M1, write in all the parameters of channel 1.

Zero-point calibration: set ON M2, if zero-point calibration is successful, X20002 is set ON.

Gain calibration: first set ON M3, write the weight value HD12 to the module. After write in success flag M4 is ON, it starts to calibrate gain. Set ON M5 to start the calibration, the preset stable time is 3s. after the scale is stable, gain calibration success flag X20002 is ON or calibration time T1 reached, reset M4, M5, gain calibration is finished.

6. Communication BD Z-NES-BD

6-1. Features

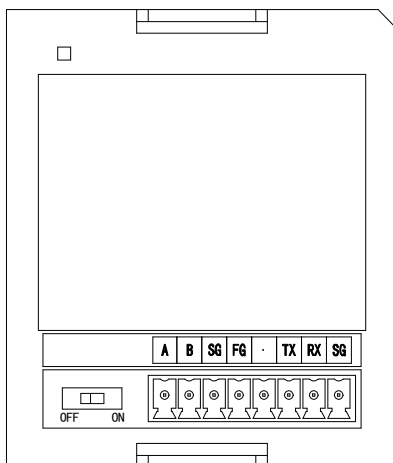

- Supports one RS232 and one RS485 communication.
- RS232 and RS485 cannot be used at the same time.

6-2. General specifications

Installation	Directly mounted on the back of ZG or ZP series integral controller
Working environment	No corrosive gas
Ambient temperature	0°C~60°C
Ambient humidity	5~95%

6-3. Installation and wiring

(1) BD board installation:

Open the BD cover of ZG3 controller, insert the BD board into the pins, then close the cover.

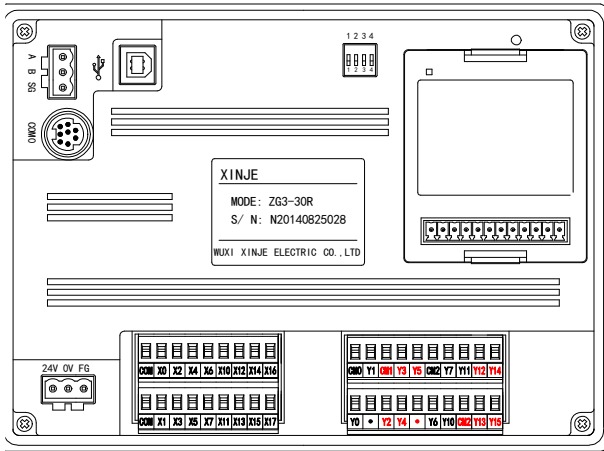

(2) Terminals:

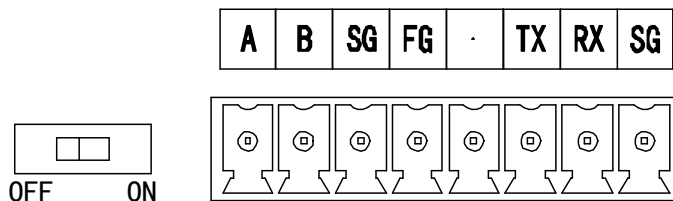

Name		Function
Wiring terminal	A	485+
	B	485-
	SG	Ground
	FG	Connect to ground terminal
	-	Vacant
	TX	RS232 send
	RX	RS232 receive
DIP switch	SG	Ground
DIP switch		For RS485 communication, if the integrated controller is in the terminal position, set the DIP switch to ON

6-4. Configuration

Z series communication BD module needs to use XDPProV3.5.3 and up version or XINJEConfig tool to configure the parameters.

For modbus communication, please use XDPProV3.5.3 and up version or XINJEConfig tool to configure the parameters. For X-NET communication, please use XINJEConfig tool to configure the parameters.

Note: If Z-NES-BD is compatible with ZG series integral controller, the port number of ZG-30 is COM3, and the

port number of ZG-20 is COM4. If the ZP series integral controller is suitable, the #1 position is COM3, the #2 position is COM4.

(1) use XDPProV3.5.3 and up version to configure the parameters:

Click Configure/PLC comm port settings.

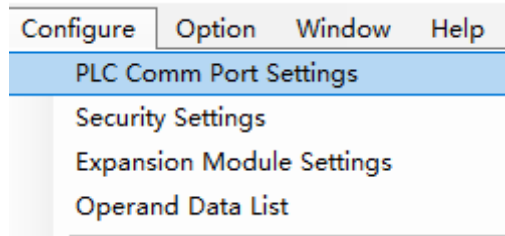

Click Add/Modbus communication:

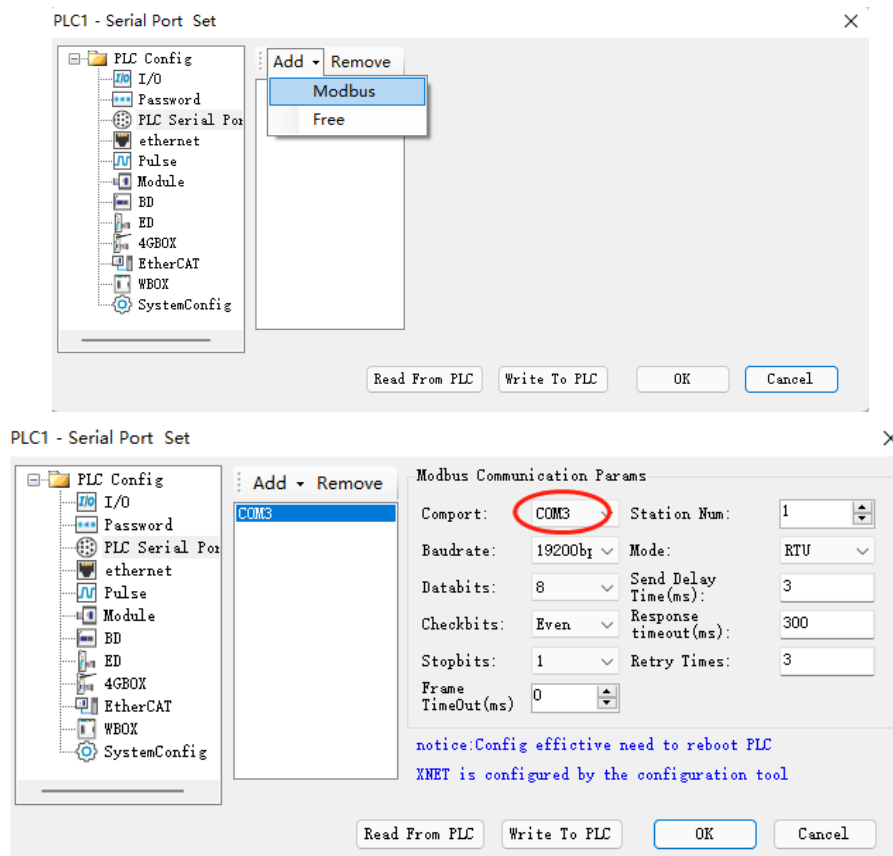

(2) XINJEConfig can configure the Modbus and X-NET mode of extension ED module. Here will explain how to configure the X-NET mode through Xinje config tool.

Installation of XINJEConfig

Please find the XNetSetUp.exe in the XDPPro installation folder. Double click it to install the Xinje config tool.

Using steps of XINJEConfig

Here we take an example of two ZG3-30T-7 PLCs communicate in X-NET mode through the Z-NES-ED.

Note: when using software to configure PLC, first use USB download cable to connect PLC with computer. The

USB download cable here is the download cable of the HMI, as shown in the following figure:



The USB cable needs to install USB driver, please use the file VirtualCOMSetUp.exe to install the driver.

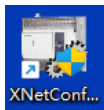

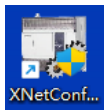
(1) Double click  to open the Xinje config tool.

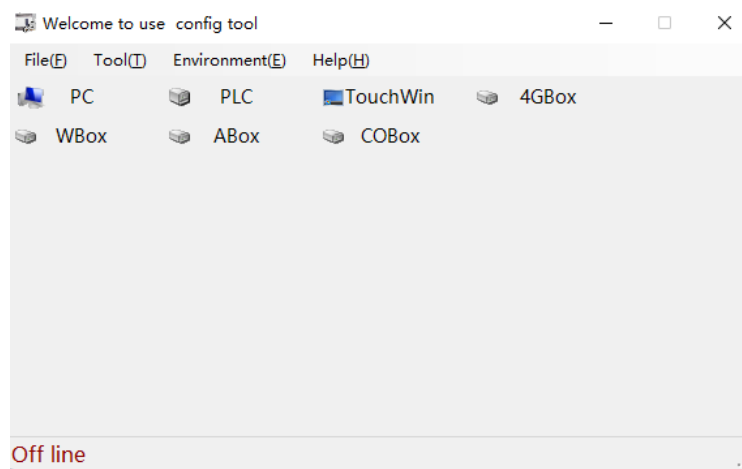

(2) Click PLC to show below window. Select Xnet protocol and COM3 port. Then click Find device.

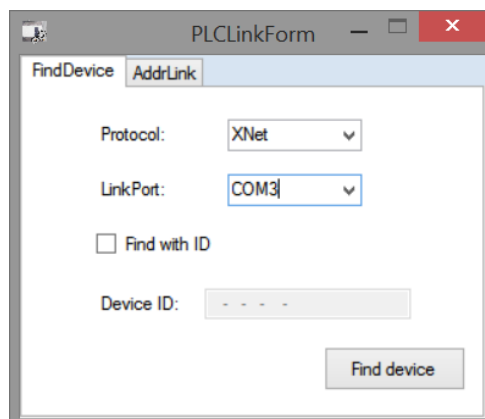

(3) It will show PLC configuration window:

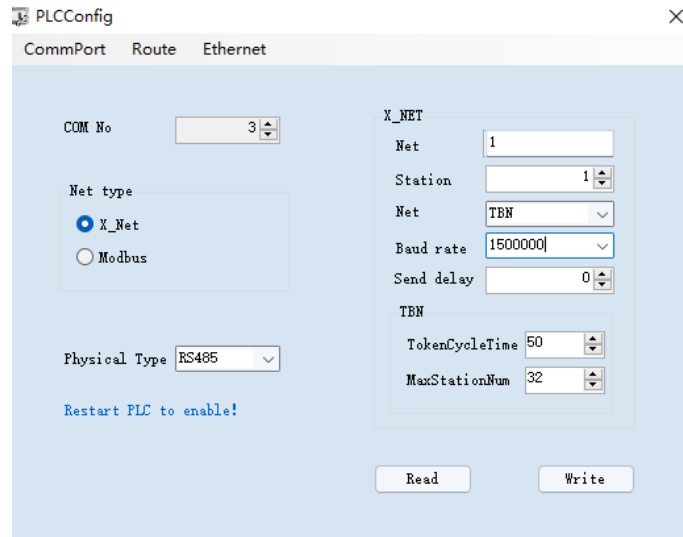

Since ZG3 can only expand one BD board, namely COM3 port, Z-NES-ED is configured in Comport NO.3. We want to do X-NET communication, so in the "ChooseNet", select X-NET. At "ChoosePHY", select RS485.

NetID: the communication network no. constructed by the two ZG3. The network number of all the devices must be consistent in the same network. The network number can be set to any value. We define this communication network to no.1.

Station ID: the PLC station no. in the same network. We will set PLC A to no. 1, PLC B set to no.2.

Net type: there are three kinds of option, TBN is PLC communication. If the HMI communicates with PLC, please choose OMMS or TBN, please choose OMMS when the PLC communicates with servo drive. Here we will set to TBN. The net type in the same network must be consistent.

Baud rate: we choose 1.5M.

Token cycle time: it refers to the time that each site in a network circulates once. In this example, there are two PLC, we set it to 10ms.

Max station number: it refers to the maximum number of devices in a network. Since X-NET communication cannot exceed 32 nodes, we set it to 32 here.

(4) click write config, it will show write in succeeded information.

(5) click ok, then cut the PLC power and power on again to make the parameters effective.

(6) return to the main interface, click Route in the PLC config window.

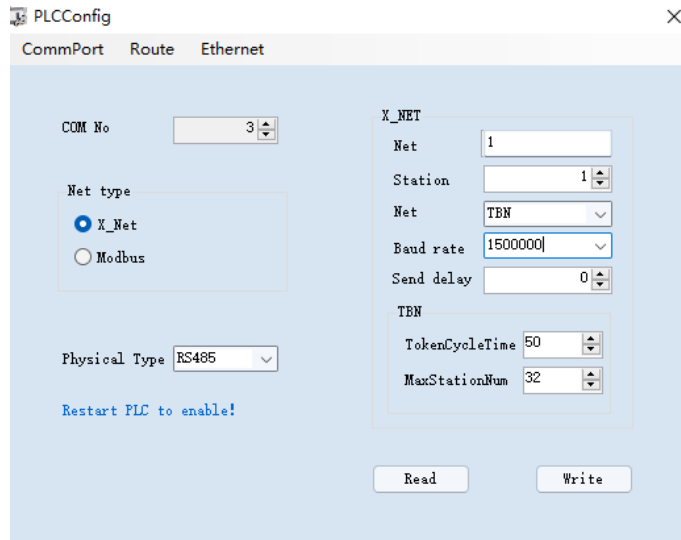

(7) It will show Route config window.

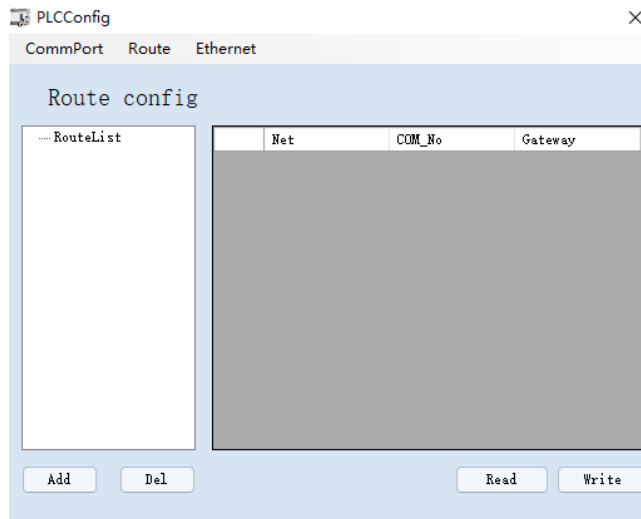

(8) Click Add, it will show below window.

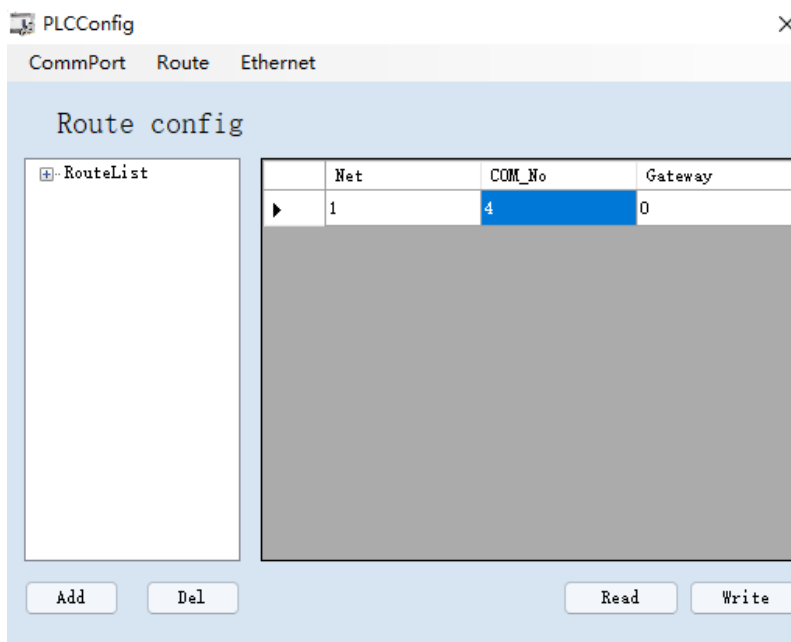

The "Net" here refers to the "network number" previously configured in the "comport config" window, "Com_No" refers to the physical interface of PLC communication connection, that is, the serial port. We use terminal A and B on the expansion board Z-NES-BD, so the Com_No is 4, "Gateway" here defaults to 0, and other unused configuration items can be deleted.

- (9) after configuration, click write, it will show write in successful information.
- (10) close the XINJEConfig tool, then cut the PLC power and power on again to make the setting effective.
- (11) The settings of PLC B is same to PLC A. (only the station ID is different). Please set as above steps.

Note: after changing the device, it needs to configure again.

The other details please refer to X-NET manual, modbus instructions please refer to XD/XL programming manual.

7. I/O expansion module Z-nXmY-BD

7-1. Features

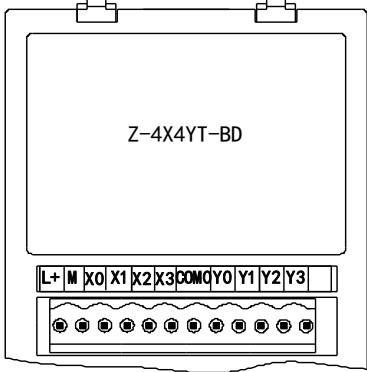

- 8 channels digital input BD: Z-8X-BD;
- 8 channels digital output BD: Z-8YT-BD;
- 4 channels digital input , 4 channels digital output BD: Z-4X4YT-BD;
- ZG3/ZGM series integral controller can expand 1 BD board;
- ZP series integral controller can be extended to 2 BD boards.

7-2. General specifications

7-2-1. Module types

Model		Function
NPN input	PNP input	
Z-4X4YT-BD	-	4 channels digital input,4 channels digital output
Z-8X-BD	-	8 channels digital input
Z-8YT-BD	-	8 channels digital output

7-2-2. Module Specifications

Items	Specifications
Application environment	No corrosive gas
Environment temperature	0°C~60°C

Storage environment temperature	-20~70°C
Environment humidity	5~95%RH
Storage environment humidity	5~95%RH

7-3. Terminals

Z-8X-BD:

L+	M	X0	X1	X2	X3	X4	X5	X6	X7	●	●
----	---	----	----	----	----	----	----	----	----	---	---

Z-8YT-BD:

COM0	Y0	Y1	Y2	Y3	COM1	Y4	Y5	Y6	Y7	●	●
------	----	----	----	----	------	----	----	----	----	---	---

Z-4X4YT-BD:

L+	M	X0	X1	X2	X3	COM0	Y0	Y1	Y2	Y3	●
----	---	----	----	----	----	------	----	----	----	----	---

Note: (1) When wiring X terminal, external DC24V power supply is needed, please connect 24V+ to L+ terminal and 24V- to M terminal; In addition, the M terminal is also the common terminal of the input point X;
(2) the output Y0 ~ corresponding COM0 Y3, Y4 output point ~ Y7 corresponding COM1.

7-4. I/O address assignment

Z series I/O expansion BD board does not occupy I/O unit, the channel corresponding PLC register definition number is as follows:

◆ Z-8X-BD

	X0	X1	X2	X3	X4	X5	X6	X7
#1 BD	X20000	X20001	X20002	X20003	X20004	X20005	X20006	X20007
#2 BD	X20100	X20101	X20102	X20103	X20104	X20105	X20106	X20107

◆ Z-8YT-BD

	Y0	Y1	Y2	Y3	Y4	Y5	Y6	Y7
#1 BD	Y20000	Y20001	Y20002	Y20003	Y20004	Y20005	Y20006	Y20007
#2 BD	Y20100	Y20101	Y20102	Y20103	Y20104	Y20105	Y20106	Y20107

◆ Z-4X4YT-BD

	X0	X1	X2	X3	Y0	Y1	Y2	Y3
#1 BD	X20000	X20001	X20002	X20003	Y20000	Y20001	Y20002	Y20003
#2 BD	X20100	X20101	X20102	X20103	Y20100	Y20101	Y20102	Y20103

7-5. Installation and wiring

7-5-1. BD board installation:

Open the BD cover of ZG3 controller, insert the BD board into the pins, then close the cover.

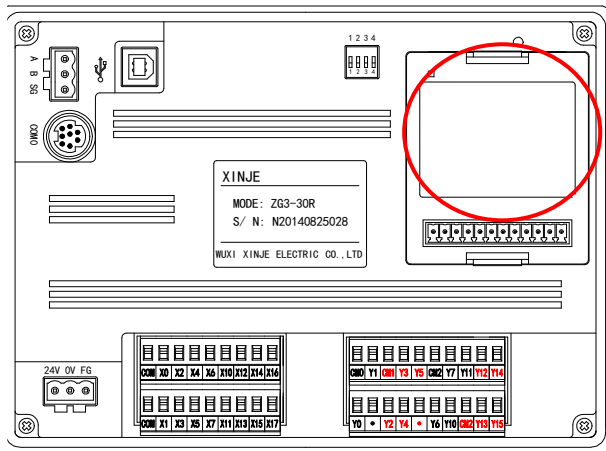

7-5-2. Input specifications and wiring

NPN input

Items	Contents
Input signal voltage	DC24V±10%
Input signal current	7mA/DC24V
Input ON current	Over 4.5mA
Input OFF current	Under 1.5mA
time response to step input	About 10ms
Input signal form	Contact NPN input to open collector transistor
circuit insulating voltage	Photoelectric coupling insulation
Input action display	None

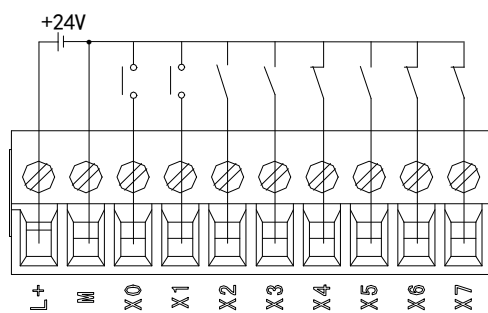

Switch button wiring diagram

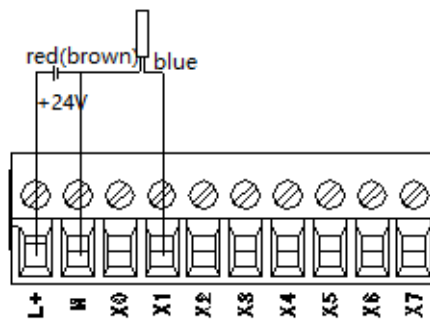

Two wire (normally open or normally closed) proximity switch wiring diagram

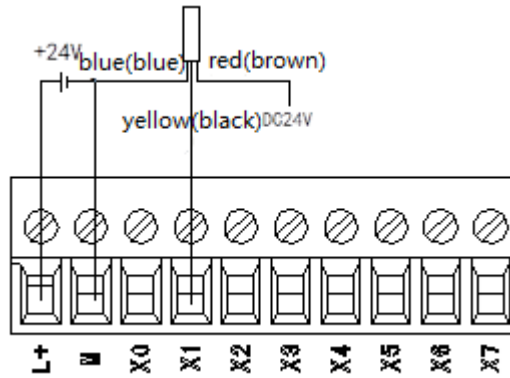

Three-wire (NPN type) proximity switch wiring diagram

7-5-3. Power condition

Only Z-8X-BD and Z-4X4YT-BD need access to 24V power supply.

Items	Contents
nominal voltage	DC24V
Operating voltage range	DC21.6V~26.4V
Input current	120mA DC24V
Allow instant power - off time	10ms DC24V
impulse current	10A DC26.4V
Max power dissipation	1.3W

7-5-4. Output specifications and wiring

Transistor output

external power supply	DC5~30V	
circuit insulating voltage	Coupling of light insulation	
Action	-	
maximum load	Resistive load	0.3A
	Inductive load	8W/DC24V
	Lamp load	1.5W/DC24V
Minimum load	DC5V 2mA	
Open contact leakage current	Under 0.1mA	
Response Time	OFF→ON	Under 0.2ms
	ON→OFF	Under 0.2ms

Transistor output processing basic unit of the transistor output from 2 to 4 common side output.

Load driver with power use DC5 ~ 30V regulated power supply.

Between internal loop programmable controller with output transistor is using photoelectric coupler insulation isolation; In addition, the common end blocks are separated from each other.

When driving optical coupling, LED light is ON, and the output transistor is ON.

The time of PLC from photoelectric coupler drive (or cut OFF) to transistor ON (or OFF) is less than 0.2ms.
 The current of each output point is 0.3a; However, due to the temperature rise limit, the total current of each output 4 points is 0.8A.
 Open circuit current below 0.1mA.

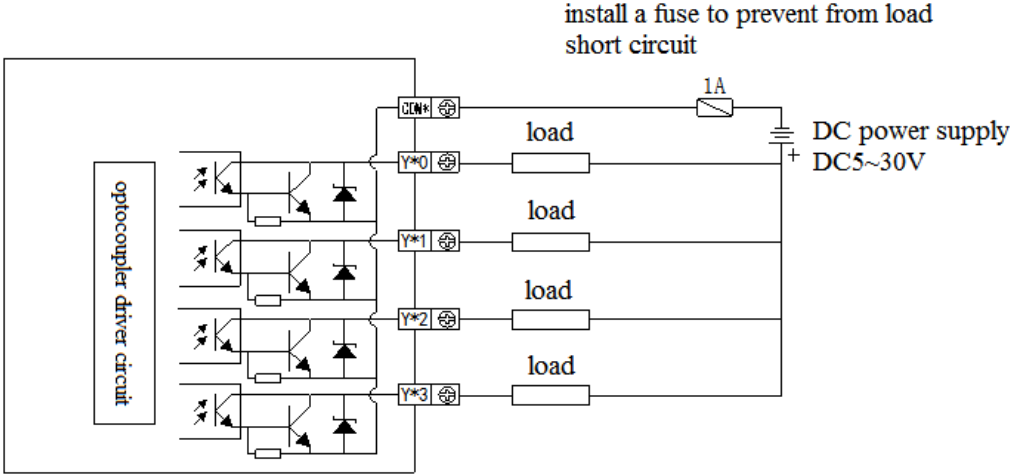

7-6. Software configuration

Step 1: Open the programming software XDPPro (V3.5.2 or above) and click 'PLC Config' - "BD " in the left engineering bar:

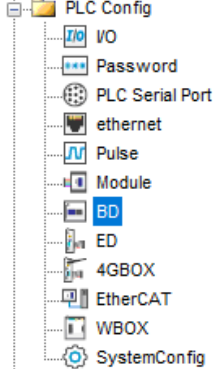

Choose the BD board model in the window:

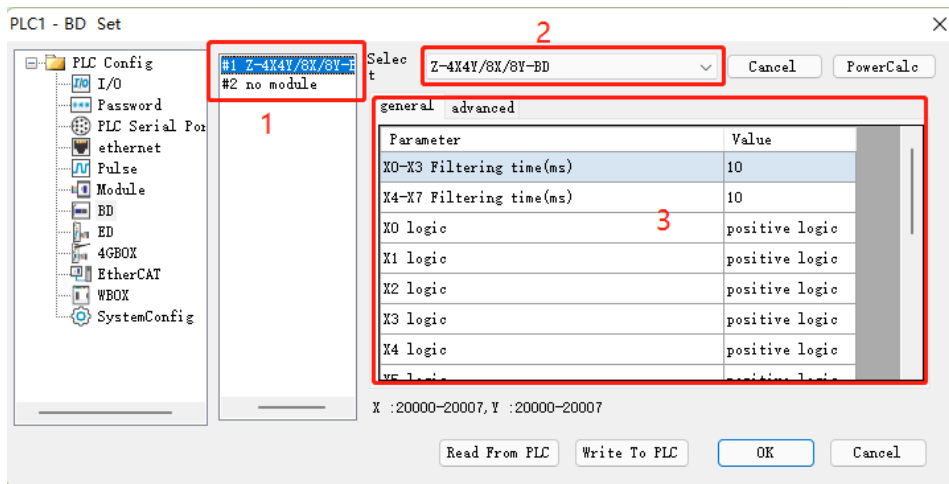

Step 2: Select the corresponding BD model in the icon '2'

Step 3: After Step 2, the corresponding model is displayed at '1'.

Step 4: In addition, parameters such as BD filtering time and positive and negative logic can be selected in '3'.

Step 5: After the configuration is complete, click write to PLC, and then power PLC off and on again, the configuration can take effect!

8. Thermocouple temperature control module Z-4TC-BD

8-1. Features

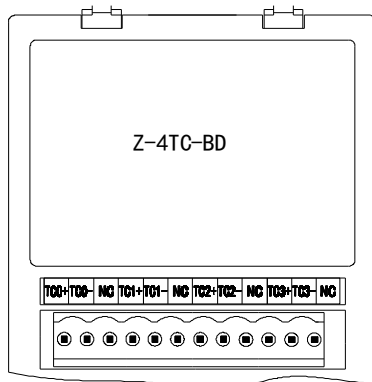

- Analog input of 4-channel thermocouple temperature sensor, supporting multiple thermocouple types.
- Resolution is 0.1°C
- Used for ZG/ZP series

8-2. General specifications

Item	Contents	
Analog signal input	Thermocouple K, S, E, N, B, T, J, R	
Temperature measurement range	K	-200°C~1340°C
	S	-50°C~1764°C
	E	-200°C~708°C
	N	-200°C~1300°C
	B	-250°C~1798°C (Display room temperature below 250°C)
	T	-200°C~400°C

Item	Contents	
	J	-210°C~930°C
	R	-50°C~1768°C
Digital output range	0~max temperature measurement value×10 (take type K as an example, the digital output range is -2000~13400)	
Resolution	0.1°C	
Integrate precision	±1% (relative max value)	
Conversion speed	80ms per channel	
Point occupy	0 points (the data are operated in data register, it will not be limited by PLC max I/O points)	

8-3. Installation and wiring

(1) BD board installation:

Open the BD cover of ZG3 controller, insert the BD board into the pins, then close the cover.

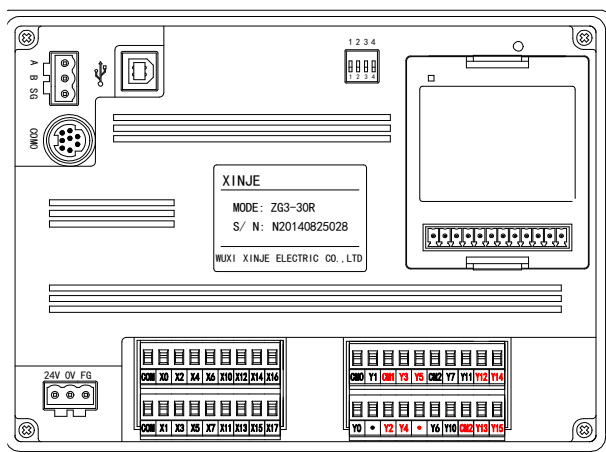

Channel	Terminal name	Signal name
	NC	-
CH3	TC3+	3CH thermocouple input +
	TC3-	3CH thermocouple input -
	NC	-

(3) mode of connection

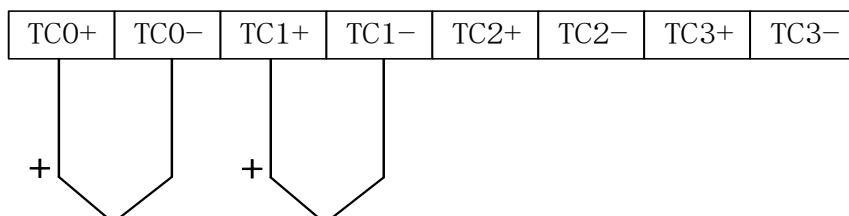

Note: TC+ connected to the thermocouple sensor signal positive, TC- connected to the thermocouple sensor signal negative.

8-4. I/O address assignment

The BD board does not occupy the I/O unit, and the converted value is directly sent into the PLC register. The PLC register definition number corresponding to the channel is:

relative parameters	0CH	1CH	2CH	3CH
Channel display temperature (0.1°C)	ID20000	ID20001	ID20002	ID20003
Channel thermocouple connection status (0 is cable connection, and 1 is disconnection)	X20000	X20001	X20002	X20003

Note: The temperature value in the ID register will be displayed as -1 when the connection is broken. An internal sampling timeout error occurs when the value is -2. Please check whether there is bad contact between the integral controller and BD board. If sampling error occurs, disconnection will be suggested.

8-5. Software configuration

Open the programming software XDPPro (V3.5.2 or above) and click 'PLC Config' - "BD " in the left engineering bar:

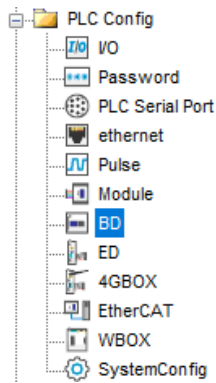

Choose the BD board model in the window:

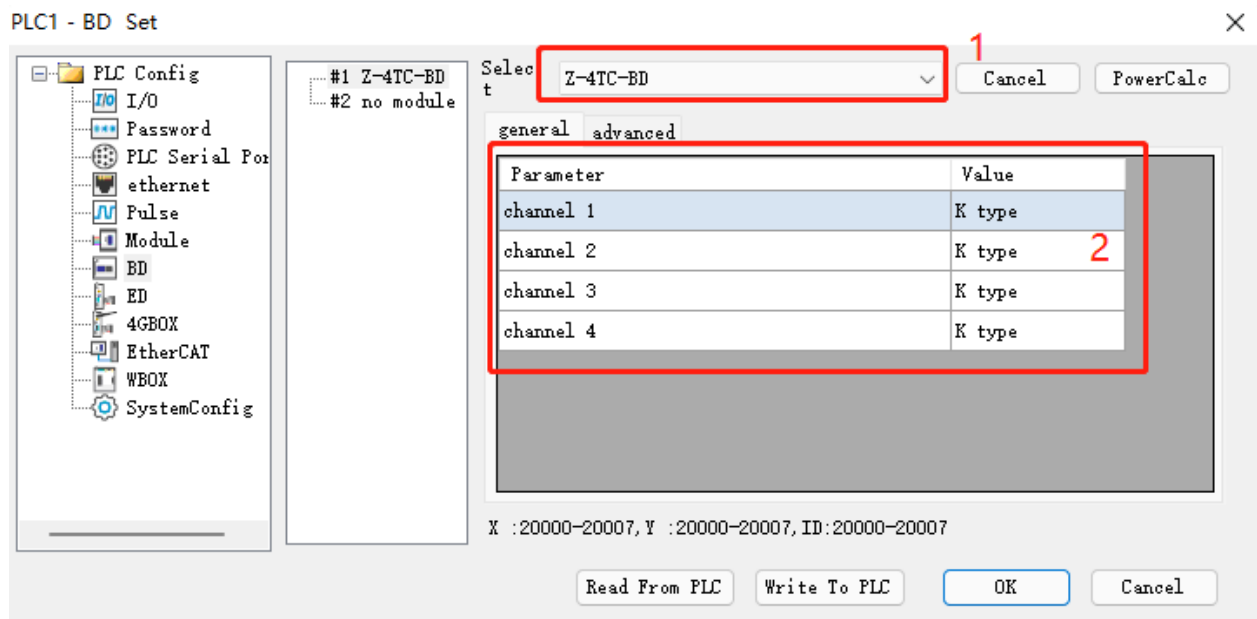

After the configuration is complete, click write to PLC, and then power PLC off and on again, the configuration can take effect.

8-6. Application program

For example: Read the temperature of 4 channels in real time.

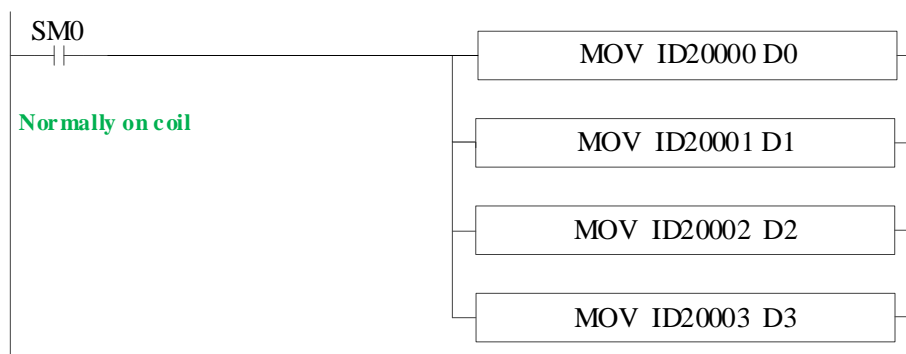

Explanation: SM0 is always ON coil, it is ON when PLC is running.

write the channel 0 of 1#BD temperature data in register D0;

write the channel 1 of 1#BD temperature data in register D1;

write the channel 2 of 1#BD temperature data in register D2;
 write the channel 3 of 1#BD temperature data in register D3;

9. Pt100 temperature control module Z-4PT3-BD

9-1. Features

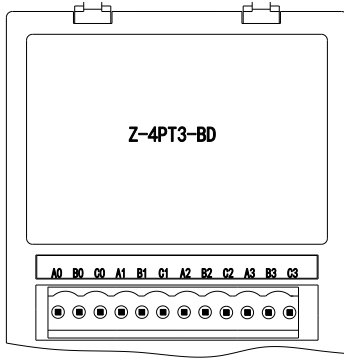

- Four channels, Pt100 platinum thermal-resistance
- Display temperature resolution is 0.1°C.
- Used for ZG/ZP series integral controller

9-2. General specifications

Item	Content
Analog input signal	Pt100 platinum thermal-resistance
Temperature measurement range	-100°C ~ 500°C
Digital output bound	-1000~5000, 16 bits with sign bit, binary
Resolution	0.1°C
Integrate precision	±1% (relative max value)
Conversion speed	450ms every 4 channels
Point occupy	0 points (the data are operated in data register, it will not be limited by PLC max I/O points)

9-3. Installation and wiring

(1) BD board installation:

Open the BD cover of ZG3 controller, insert the BD board into the pins, then close the cover.

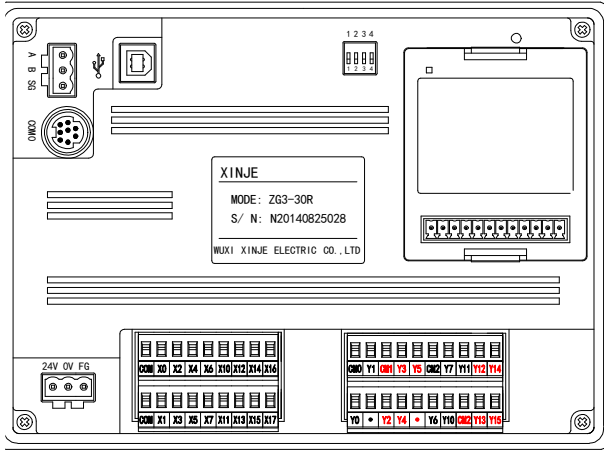

(2) Terminals:

TC0+TC0-	NC	TC1+TC1-	NC	TC2+TC2-	NC	TC3+TC3-	NC
----------	----	----------	----	----------	----	----------	----

Channel	Terminal	Signal
CH0	TC0+	0CH thermocouple input +
	TC0-	0CH thermocouple input -
	NC	-
CH1	TC1+	1CH thermocouple input +
	TC1-	1CH thermocouple input -
	NC	-
CH2	TC2+	2CH thermocouple input +
	TC2-	2CH thermocouple input -
	NC	-
CH3	TC3+	3CH thermocouple input +
	TC3-	3CH thermocouple input -
	NC	-

(3) mode of connection

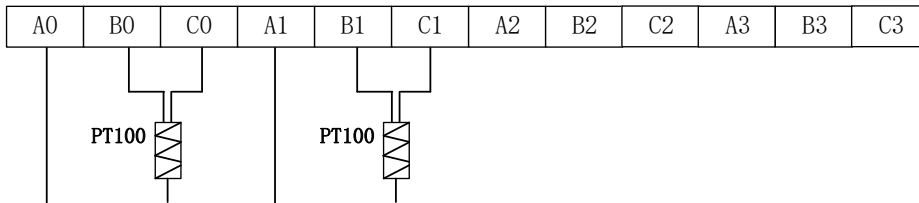

9-4. I/O address assignment

The BD board does not occupy the I/O unit, and the converted value is directly sent into the PLC register. The PLC register definition number corresponding to the channel is:

relative parameters	0CH	1CH	2CH	3CH
Channel display temperature (0.1°C)	ID20000	ID20001	ID20002	ID20003
Channel thermocouple connection status (0 is cable connection, and 1 is disconnection)	X20000	X20001	X20002	X20003

Note: When the channel is disconnected, the temperature value in the ID register will be displayed as the maximum value 5000. When the display is 5001 for internal sample timeout error. Check whether the connection between the the integral controller and the BD board is poor. If sampling error occurs, the channel is disconnected.

9-5. Software configuration

Open the programming software XDPPro (V3.5.2 or above) and click ‘PLC Config’ - "BD " in the left engineering bar:

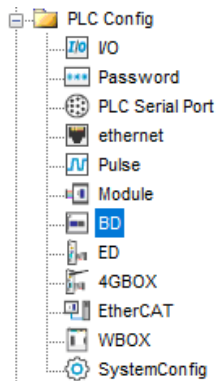

Choose the BD board model in the window:

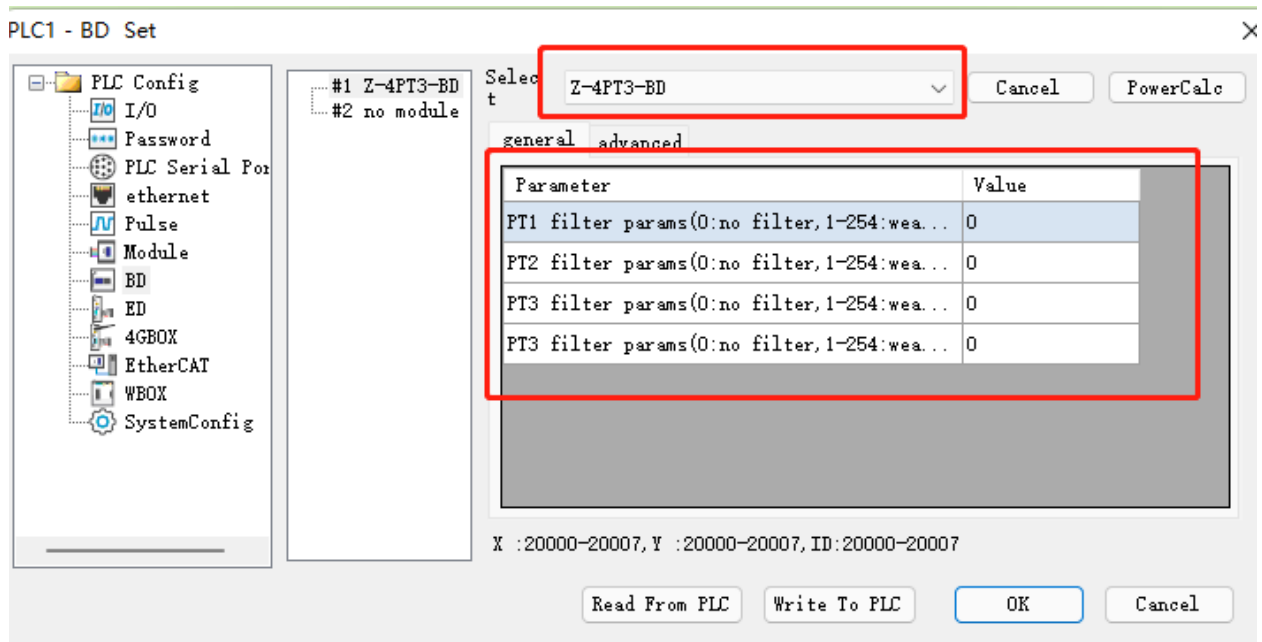

After the configuration is complete, click write to PLC, and then power PLC off and on again, the configuration can take effect.

9-6. Application program

For example: Read the temperature of 4 channels in real time.

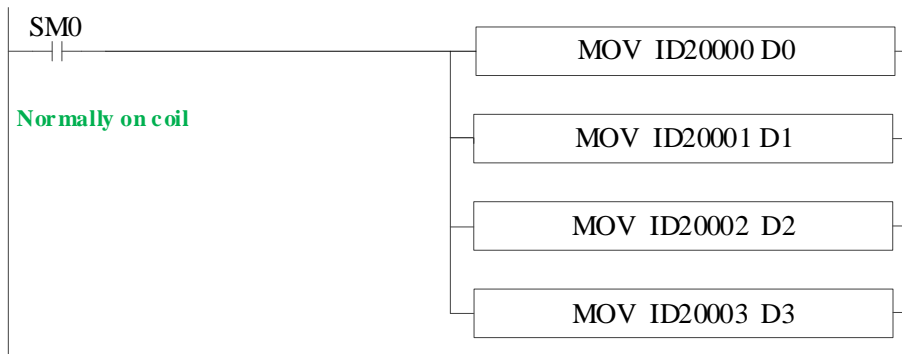

Explanation: SM0 is always ON coil, it is ON when PLC is running.

write the channel 0 of 1#BD temperature data in register D0;

write the channel 1 of 1#BD temperature data in register D1;

write the channel 2 of 1#BD temperature data in register D2;

write the channel 3 of 1#BD temperature data in register D3;

10. Application

Program application:

Take Z-3AD3PT-BD as an example. The pressure sensor range is 0~15Kpa, the corresponding output voltage range is 0~10V. It needs to display the real-time pressure on the HMI screen (register D10, display 3-bit decimal, unit is Kpa).

Program:

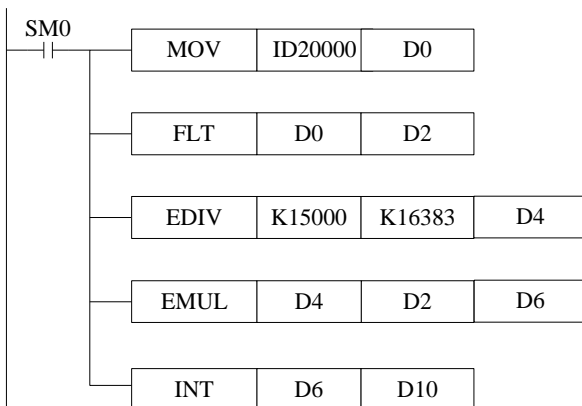

Explanation:

ID20000: pressure value, digital register

D0: pressure value

D2: pressure value, floating number

D4: pressure floating number of each digital value

D6: actual pressure floating number

D10: actual pressure integer value, the range is magnified 1000 times, it can display 3-bit decimal to improve precision.

In this example, the digital value related to analog sampled value is 10, the transformed data is 0.009Kpa. the data displayed on the HMI:



Note: D2/D4/D6 are floating numbers, they will display in decimal format in program. Take D2 as an example: D2, D3 store the floating number 10 in decimal format (32-bit). Please select floating format to show the number in the software.

XINJE



WUXI XINJE ELECTRIC CO., LTD.
No.816, Jianzhu West Road, Binhu District,
Wuxi City, Jiangsu Province, China
214072
Tel: (510) 85134136
Fax: (510) 85111290
www.xinje.com